

**X-RAY INTERACTIONS: PHOTOABSORPTION, SCATTERING, TRANSMISSION,
AND REFLECTION AT $E = 50\text{--}30,000$ eV, $Z = 1\text{--}92$**

B. L. HENKE,* E. M. GULLIKSON, and J. C. DAVIS

Center for X-Ray Optics
Lawrence Berkeley Laboratory
Berkeley, California 94720

The primary interactions of low-energy x rays within condensed matter, viz. photoabsorption and coherent scattering, have been described for photon energies outside the absorption threshold regions by using atomic scattering factors. The atomic scattering factors may be accurately determined from the atomic photoabsorption cross sections using modified Kramers–Kronig dispersion relations. From a synthesis of the currently available experimental data and recent theoretical calculations for photoabsorption, the angle-independent, forward-scattering components of the atomic scattering factors have been thus semiempirically determined and tabulated here for 92 elements and for the region 50–30,000 eV. Atomic scattering factors for all angles of coherent scattering and at the higher photon energies are obtained from these tabulated forward-scattering values by adding a simple angle-dependent form-factor correction. The incoherent scattering contributions that become significant for the light elements at the higher photon energies are similarly determined. The basic x-ray interaction relations that are used in applied x-ray physics are presented here in terms of the atomic scattering factors. The bulk optical constants are also related to the atomic scattering factors. These atomic and optical relations are applied to the detailed calculation of the reflectivity characteristics of a series of practical x-ray mirror, multilayer, and crystal monochromators. Comparisons of the results of this semiempirical, “atomic-like” description of x-ray interactions for the low-energy region with those of experiment and *ab initio* theory are presented. © 1993 Academic Press, Inc.

* Present address: 1324 Peartree Lane, Medford, OR 97504.

CONTENTS

I. INTRODUCTION: DEFINING THE ATOMIC SCATTERING FACTOR	183
II. BASIC RELATIONS FOR SCATTERING WITHIN CONDENSED MATTER	184
A. Reflection and Transmission by a Layer of Atoms or Unit Cells: Defining the Structure Factor	185
B. Dynamical Reflection and Transmission for a Semi-Infinite Solid	187
C. Reflection and Transmission for a Finite Slab of N Layers	188
D. Calculation of the Coherently Transmitted and Reflected Radiation Intensities	189
E. Estimation of the Incoherently Scattered Radiation Intensities	189
III. NON-BRAGG DYNAMICAL REFLECTION AND TRANSMISSION BY MULTILAYERS	191
A. Non-Bragg Reflection at Normal Incidence for a Semi-Infinite Solid	191
B. Non-Bragg Reflection and Transmission at Normal Incidence for an N -Layer System	191
1. Relating $f_2(0)$ and β to Photoabsorption Cross Sections	191
2. Transmission Measurement of Photoabsorption Cross Sections	192
C. Non-Bragg Fresnel Reflection at Small Angles for the Semi-Infinite Solid	193
1. Reflection from an Ideally Smooth Surface	193
2. Effect of Surface Structure upon Mirror Reflectivity	193
IV. BRAGG DYNAMICAL REFLECTION AND TRANSMISSION BY MULTILAYERS	193
A. MF Values for Natural Crystal Multilayers	195
B. MF Values for Langmuir-Blodgett Multilayers	196
C. MF Values for Sputtered-or-Evaporated Multilayers	197
V. KINEMATICAL APPROXIMATION RELATIONS FOR BRAGG REFLECTION	198
VI. SEMIEMPIRICAL CALCULATION OF THE ATOMIC SCATTERING FACTORS AND SYNTHESIS OF THE PHOTOABSORPTION DATA	200
VII. EXPERIMENTAL VERIFICATION OF "ATOMIC-LIKE" SCATTERING WITHIN CONDENSED MATTER: THRESHOLD LIMITS	202
APPENDIX: DISPERSION RELATIONS FOR THE SEMIEMPIRICAL DETERMINATION OF ATOMIC SCATTERING FACTORS, COMPARISON WITH RESULTS OF <i>AB INITIO</i> THEORY, AND ESTIMATION OF INCOHERENT SCATTERING CROSS SECTIONS	205

EXPLANATION OF TABLES 211

TABLES

I. Photoabsorption Cross Sections and Atomic Scattering Factors, $Z = 1-92$, $E = 50-30,000$ eV 213

II. Incoherent Scattering Cross Sections, $Z = 2-18$, $E = 1000-30,000$ eV 305

III. Specular Reflectivity for Mirrors: Be, C, Al, Al_2O_3 , SiO_2 , Ni, Cu, Mo, Pt, and Au 306

IV. Bragg Reflection Characteristics for Natural Crystals: Si(422), Ge(422), LiF(220), Si(220), $CaF_2(220)$, Ge(220), LiF(200), Cu(111), Al(111), Si(111), $CaF_2(111)$, Ge(111), C(0002), InSb(111), ADP(200), PET(002), ADP(101), Mica(002), TAP(001), RAP(001), and KAP(001) 316

REFERENCES FOR PHOTOABSORPTION DATA 337

I. INTRODUCTION: DEFINING THE ATOMIC SCATTERING FACTOR

In the low-energy x-ray region the primary interactions of x rays with matter are photoabsorption and coherent scattering. Incoherent (Compton) scattering is significant only for the light elements at the higher energies of interest here. At the atomic level these processes may be accurately described using the complex atomic scattering factors. [See, for example, the comprehensive work of R. W. James, *The Optical Principles of the Diffraction of X-Rays* (Ref. 1).] The atomic scattering factor, $f = f_1 + if_2$, is defined in Fig. 1 as the factor by which one must multiply the amplitude scattered by a single free electron to yield the total amplitude coherently scattered by the particular atom. The scattered electric field from an atom is therefore

$$A = -A_0 \frac{r_0}{r} P(\phi) f, \quad (1)$$

where A_0 is the incident electric field, r is the distance from the atom to the observation point, r_0 is the classical electron radius (e^2/mc^2), and the polarization factor, $P(\phi)$, is unity for an incident electric field vector that is perpendicular to the plane of scattering (σ polarization) and is equal to $\cos \phi$ for an incident electric field vector that is in the plane of scattering (π polarization). In the discussions that follow, where we are concerned with re-

flection from atomic planes, the scattering angle, ϕ , is replaced by 2θ , where θ is the grazing angle of incidence and reflection measured relative to a plane of atoms.

A description of the interaction of x rays with condensed matter may be obtained from the atomic scattering factors if it can be assumed that the individual atoms scatter independently, that is, unaffected by the condensed state of the system. As is shown, this is a good assumption for photon energies above about 50 eV and which are sufficiently outside the absorption threshold regions. In this atomic description, the total coherently scattered amplitude is simply the vector sum of the amplitudes scattered by the individual atoms.

For wavelengths that are long compared with atomic dimensions and/or for small scattering angles (when the scattering amplitudes are in phase) the atoms scatter as dipoles and the atomic scattering factor becomes independent of the angle of scattering. We define here this angle-independent dipole atomic scattering-factor limit as $f_1(0) + if_2(0)$, with the following general expression for the atomic scattering factor for all angles of scattering and for all photon energies of interest,

$$f = f_1 + if_2 = f_1(0) - \Delta f_0(\theta) + if_2(0), \quad (2)$$

where $\Delta f_0(\theta)$ is an angle-dependent correction which re-

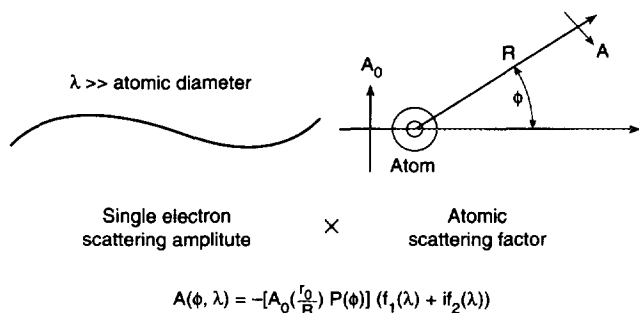

Figure 1. Defining the atomic scattering factor: the amplitude scattered by an atom can be expressed as a complex number, the atomic scattering factor $f = f_1 + if_2$, times the amplitude that would be scattered by a single Thomsonian electron at the same position. Here r_0 is the classical electron radius, e^2/mc^2 . $P(\phi)$ is the polarization factor which is equal to $\cos \phi$ for the incident electric field vector in the scattering plane (as shown) and unity for the field vector perpendicular to this plane.

sults from the interference among waves scattered from different parts of the atom and rapidly approaches zero as $(\sin \theta)/\lambda$ becomes small. It is shown that $\Delta f_0 = Z - f_0$, where Z is the atomic number and f_0 is the well-tabulated atomic form factor. It is the angle-independent (forward) atomic scattering-factor components, $f_1(0)$ and $f_2(0)$, that are tabulated here in Table I. In Ref. 2 we relate our definition and notation for the atomic scattering factor to others given in the current literature.

If the atoms within a condensed system may be considered to scatter as dipoles (i.e., for long wavelengths and/or small scattering angles) an optical electromagnetic (OEM) description often may be applied to predict the scattering interactions. Then the interaction of x rays with condensed matter may be described using the optical constants such as the complex index of refraction n_r which, as shown below, can be related to the atomic scattering factors of the individual atoms by

$$n_r = 1 - \delta - i\beta = 1 - \frac{r_0}{2\pi} \lambda^2 \sum_q n_q f_q(0), \quad (3)$$

where n_q is the number of atoms of type q per unit volume and $f_q(0)$ is the tabulated complex forward atomic scat-

tering factor for atom q . As is discussed, defining optical constants for a given wavelength and independently of scattering angle can be done only for small scattering angles or for wavelengths that are large as compared with electron density fluctuations associated with the atoms or molecules that make up the scattering units.

In the first part of this report, Sections II through V, we review the basic atomic and optical scattering relations that are most often needed in applied x-ray physics and we define these directly in terms of the atomic scattering factors. These equations describe x-ray absorption, scattering, transmission, and reflection as required in the design and application of x-ray measurements, for example, the characterization of filters, mirror monochromators and Bragg analyzers. A procedure for estimating the incoherently scattered background radiation from the light elements at the higher energies in terms of the atomic scattering factors is also given. We then outline in Section VI our semiempirical approach for the calculation of the atomic scattering factors and for our updated³ synthesis of the available experimental and theoretical photoabsorption data for the region 10 to 30,000 eV. This update is the basis of our scattering-factor calculations. Then, in Section VII, we present examples of detailed comparisons between our calculated values and those of experimental measurement for x-ray absorption and for mirror and Bragg analyzer reflection in order to demonstrate the accuracy of these descriptions as based upon the appended scattering-factor tables for photon energies in the region 50–30,000 eV. The characteristic broadened atomic photoabsorption band structure at the very low energies is noted and distinguished from that associated with the condensed matter extended x-ray absorption fine structure (EXAFS) in order to establish the threshold limits for atomic-like scattering.

In the Appendix we present an outline of the development and assumptions made in our modification of the Kramers–Kronig dispersion relations and compare the atomic scattering factors as calculated with this semiempirical approach with those of *ab initio* theory. Also presented here are the relations that have been applied for the incoherent scattered intensity in terms of the atomic scattering factors. We complete this report with the detailed tabulation of our current “best-fit” photoabsorption cross sections and atomic scattering factor data and with detailed calculations of the reflectivity characteristics of a series of practical x-ray mirror and multilayer analyzers (synthetic and natural).

II. BASIC RELATIONS FOR SCATTERING WITHIN CONDENSED MATTER

Generally we may predict the basic interactions within condensed matter, viz. reflection, absorption, and

transmission, by considering the system as a set of parallel atomic, molecular, or crystalline planes and summing the

amplitudes that are coherently scattered from these layers. The x-ray interaction within the elementary layer is assumed to be sufficiently small that a simple *kinematical* description of this interaction may be made. However, in summing for the total interaction over the large number of layers usually traversed by the incident x rays, a *dynamical* description which can account for all possible multiple reflections within the layer system is required. We outline below how this approach can lead to simple and precise analytical descriptions of the basic interactions of reflection, absorption, and transmission involved in applied x-ray physics.

A. Reflection and Transmission by a Layer of Atoms or Unit Cells: Defining the Structure Factor

We describe first the amplitude that is reflected from an elementary plane of atoms irradiated by a parallel beam of x rays. The magnitude of the total reflected amplitude at a position, B , can be most readily obtained by summing the amplitudes from the *Fresnel half-period zones* around a central point, P , as depicted in Fig. 2. These are bounded by ellipses formed by the loci of points for which the path difference to B is $n\lambda/2$ greater than that for the central ray, APB , where n is an integer order number for the loci that form successively the set of ellipses. It may easily be shown that the major and minor axes of these ellipses are given by

$$a_n = \frac{\sqrt{n\lambda r}}{\sin \theta} \quad \text{and} \quad b_n = \sqrt{n\lambda r}, \quad (4)$$

where the source point is at infinity, $r_1 = \infty$, and $r = r_2$. The areas of these annular zones are therefore constant and equal to $\pi r \lambda / \sin \theta$. However, the amplitude scattered from each successive zone is initially nearly equal to that scattered by the central elliptical zone and then these amplitudes slowly decrease as the zone number, n , increases because the mean path length and obliquity angle characteristic of all the scattering points within the successive *annuli* are increasing (see, for example, Ref. 4). The amplitude vector from each successive half-period zone reverses, thus requiring that the summed amplitudes simply approach *half* that from the central zone (as depicted in Fig. 2). An integration for the total amplitude scattered from this central zone yields the result with a factor of $-i/2\pi$ times the number of atoms per unit area, m , times the central zone area, $\pi a_1 b_1$, times the amplitude scattered per atom at angle 2θ , A (for a more rigorous treatment for the scattering by a sheet of atoms see, for example, the classic text *X-Rays in Theory and Experiment* by A. H. Compton and S. K. Allison⁵). Thus, we obtain for the amplitude, measured at B , reflected by an atomic layer

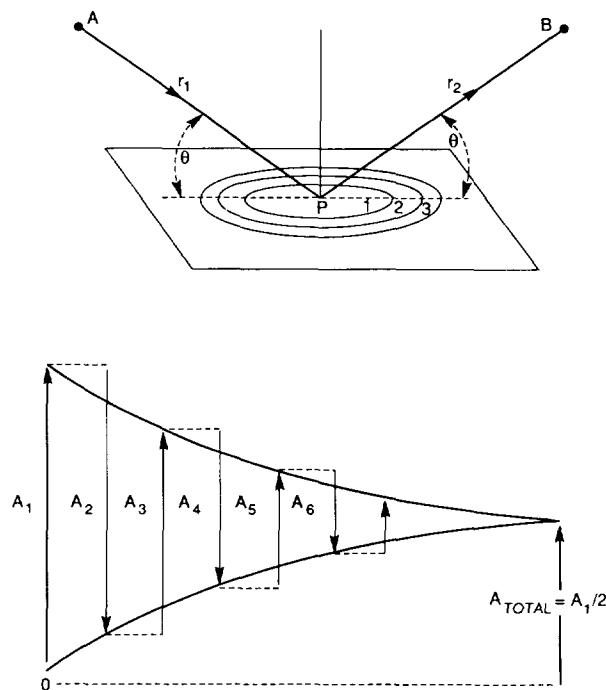

Figure 2. The amplitude scattered from an atomic plane as determined by the Fresnel half-period zone construction, where A is the source point and B is the point of measurement. The annular zones are defined by ellipses such that the distance traveled by the ray scattered from an atom on the n th ellipse is $n\lambda/2$ greater than the distance traveled by a ray scattered from the central point, P . The total amplitude scattered by all the zones approaches one-half that which is reflected by the central zone, as suggested by the vector summation diagram. (Top) X-ray reflection from a thin layer; (bottom) half-period zone amplitude addition.

of lateral dimensions that are very large compared with the x-ray wavelength,

$$A_B = -i \frac{2}{\pi} \frac{\pi r \lambda}{\sin \theta} \frac{mA}{2}. \quad (5)$$

The factor of $-i$ indicates that the phase of the amplitude reflected from an atomic plane lags 90° behind that of the amplitude, A , scattered by the atom at position P .

Using Eq. (1) for the amplitude A scattered by a single atom we have for the fractional amplitude reflected by an atomic plane

$$A_B/A_0 = i \frac{r_0 \lambda}{\sin \theta} P(2\theta) m f. \quad (6)$$

If the atomic plane is composed of different atoms, with m_q type q atoms per unit area, we simply replace mA in Eq. (5) by $\sum_q m_q A_q$, obtaining for the reflection by a

composite atomic layer

$$A_B = -i \frac{r\lambda}{\sin \theta} \sum_q m_q A_q \quad (7)$$

Note that if the atomic plane is not perfectly uniform but rather includes inhomogeneities (e.g., "holes" or variations in atomic number densities), an average value of $\sum_q m_q A_q$ may be used to accurately yield the reflected amplitude *provided* that the areal dimensions of the density fluctuations are small compared with those of the Fresnel zones, viz. $\pi r\lambda/\sin \theta$. This criterion can be useful in the modeling of nonuniform systems or rough or diffused reflecting interfaces as has been discussed in Ref. 6.

Often x-ray interactions within condensed matter may be considered to be with periodic layered structures such as in a crystal. Depicted in Fig. 3 is such a solid with the layered structures that are *parallel* to the sample surface (defined below as a *multilayer*). Typically, for x-ray wavelengths, these elementary Bragg reflecting layer systems may be considered "thin," so that the incident amplitude at each atomic layer of the system or cell is essentially the same and the effect of multiple reflections within the thin elementary layer system can be neglected. We may then accurately sum the amplitudes reflected by this cell of atomic planes, which is periodically repeated within the solid with a spacing of d , by simply performing the kinematical vector sum

$$A_B = -i \frac{r\lambda}{\sin \theta} \sum_q m_q A_q \exp\left(\frac{i4\pi z_q}{\lambda} \sin \theta\right), \quad (8)$$

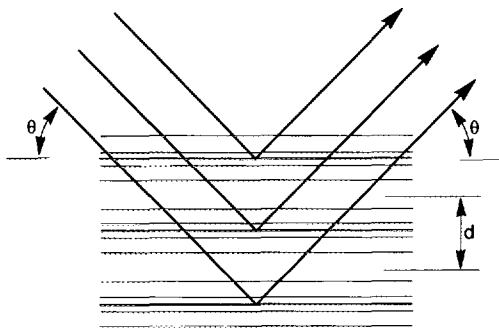

Figure 3. Defining the *multilayer*: a periodic system of layered structures that establishes characteristic groups or "cells" of atomic reflecting planes that are parallel to the multilayer surface. Analyzer reflectivity is thus simply determined by the one-dimensional distribution of scattering atoms within the cell. Most practical Bragg analyzers are of this type of structure.

in which z_q is the distance of the q -type atoms from a reference plane and $4\pi z_q(\sin \theta)/\lambda$ is the phase shift relative to the reference plane. Finally, we may rewrite Eq. (8), in analogy to Eq. (6), as simply

$$A_B = iA_0 \frac{r_0\lambda}{\sin \theta} P(2\theta)MF, \quad (9)$$

where $F = F_1 + iF_2$ and is defined as a *structure factor* of a unit cell and M is the number of unit cells per unit area. MF is therefore equal to the structure factor per unit area of the thin periodic layer system of spacing d , and is given by

$$MF = \sum_q m_q f_q \exp\left(\frac{i4\pi z_q}{\lambda} \sin \theta\right). \quad (10)$$

Combining these results we obtain the fraction of the incident amplitude that is reflected, $-is$, and transmitted, $1 - i\sigma$, by a thin layer of M unit cells per unit area. As indicated in Fig. 4, the fractional amplitude that is reflected, $-is$, is given by

$$A_B/A_0 = -is = i \frac{r_0\lambda}{\sin \theta} MF(\theta)P(2\theta) \quad (11)$$

and $-i\sigma$ is given by

$$-i\sigma = i \frac{r_0\lambda}{\sin \theta} MF(0), \quad (12)$$

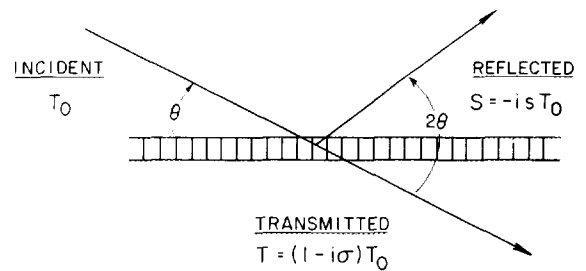

FOR M UNIT CELLS/UNIT AREA OF STRUCTURE FACTOR, $F_1 + iF_2$, AND OF AVERAGE ATOMIC SCATTERING FACTOR, $\bar{f}_1 + i\bar{f}_2 = F_1(0) + iF_2(0)$

$$-\sigma = r_0\lambda \frac{MF_1(0) + iMF_2(0)}{\sin \theta} \quad \text{AND} \quad -s = r_0\lambda \frac{MF_1(\theta) + iMF_2(\theta)}{\sin \theta} P(2\theta)$$

$P(2\theta) = 1$ OR $\cos 2\theta$ FOR THE TWO POLARIZED COMPONENTS

Figure 4. Defining the fractional amplitude that is reflected, $-is$, and that transmitted, $1 - i\sigma$, kinematically, by a thin group or cell of atomic planes characterized by its structure factor per unit area, MF . $F = F_1 + iF_2$, the unit cell structure factor, and M is the number of unit cells per unit area.

in which we have described the scattering in the forward, transmitted direction by introducing the layer's structure factor per unit area, $MF(0)$, for zero scattering angles. Following from Eq. (10) this becomes

$$MF(0) = d \sum_q n_q f_q(0) \quad (13)$$

for a distribution of n_q atoms per unit volume of species q and atomic scattering factor $f_q(0) = f_{1q}(0) + if_{2q}(0)$.

Note that for the calculation of the amplitude of the radiation that is reflected or transmitted by the layer of unit cells we have used $F(\theta)$ and $F(0)$, respectively. Hence the reflection and the transmission of a single layer (or, as shown below, for the multilayer) depend upon its composition, density, and structure simply through the quantity MF as defined here in Eqs. (10) and (13).

The transmitted amplitude for a single layer may also be expressed in terms of the complex index of refraction $n_r = 1 - \delta - i\beta$, as

$$\begin{aligned} \frac{T}{T_0} &= \exp\left(-in_r \frac{2\pi d}{\lambda \sin \theta}\right) \\ &= \exp\left(-i \frac{2\pi d}{\lambda \sin \theta} + i \frac{2\pi d}{\lambda \sin \theta} (\delta + i\beta)\right). \end{aligned} \quad (14)$$

Because the interaction parameter, σ , for a single layer is small compared to unity, we may write for the transmission of this layer

$$\begin{aligned} \frac{T}{T_0} &= (1 - i\sigma) \exp\left(-i \frac{2\pi d}{\lambda \sin \theta}\right) \\ &\simeq \exp\left(-i \frac{2\pi d}{\lambda \sin \theta} - i\sigma\right). \end{aligned} \quad (15)$$

Comparing Eqs. (14) and (15) we obtain the equations that relate the optical constants, δ and β , to $MF_1(0)$ and $MF_2(0)$,

$$\frac{2\pi d}{\lambda \sin \theta} (\delta + i\beta) \simeq -\sigma = \frac{r_0 \lambda}{\sin \theta} MF(0) \quad (16)$$

$$\delta \simeq \frac{r_0 \lambda^2}{2\pi d} MF_1(0) = \frac{r_0 \lambda^2}{2\pi} \sum_q n_q f_{1q}(0), \quad (17)$$

and

$$\beta \simeq \frac{r_0 \lambda^2}{2\pi d} MF_2(0) = \frac{r_0 \lambda^2}{2\pi} \sum_q n_q f_{2q}(0). \quad (18)$$

B. Dynamical Reflection and Transmission for a Semi-Infinite Solid

We now apply the kinematical descriptions of the interaction with a thin elementary layer system to describe the dynamical interaction within a system of a large number of layers, i.e., a semi-infinite solid. We adopt the difference equation description of Darwin and Prins which is presented in detail in Refs. 5 and 1 beginning with the two difference equations, as illustrated in Fig. 5, one describing the amplitude of the total wave, S_r , proceeding upward from the top of the r th layer and the other equation describing the amplitude, T_{r+1} , of the total wave proceeding downward to the top of the $(r + 1)$ th layer:

$$S_r = -isT_r + (1 - i\sigma)e^{-i\Delta} S_{r+1} \quad (19)$$

and

$$T_{r+1} = (1 - i\sigma)e^{-i\Delta} T_r - i\bar{\sigma}e^{-i2\Delta} S_{r+1}. \quad (20)$$

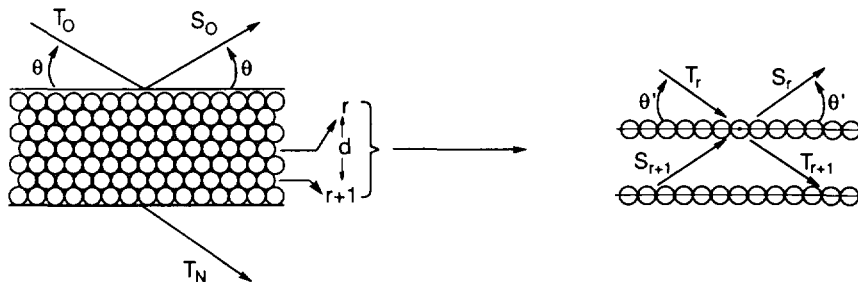

Figure 5. The self-consistent difference equations that relate the total downward- and upward-progressing wave amplitudes, T and S , at the top of the r th and the $(r + 1)$ th layers on a semi-infinite multilayer. Their solution leads to the Darwin-Prins dynamical reflectivity S_0/T_0 , given in Eq. (26).

In these self-consistent equations all possible multiple reflection components in both the downward- and the upward-progressing waves are dynamically included. Here $-i\bar{s}$ is the amplitude reflection ratio for the wave reflecting from *below* a layer and is equal to $-is$ for the typical case of a symmetrical unit cell. The additional phase difference between contributions from successive layers of spacing d is Δ and 2Δ for the transmitted and reflected waves, respectively, where Δ is given by

$$\Delta = 2\pi d(\sin \theta)/\lambda. \quad (21)$$

By assuming a reasonable transmission law for the downward- and upward-progressing waves within a semi-infinite solid,

$$T_{r+1} = xT_r, \quad S_r = xS_{r+1}, \quad (22)$$

one may then obtain without approximation a solution of the difference equations (19) and (20) which yields for the amplitude ratio, S_0/T_0 , from the surface of a semi-infinite solid,

$$S_0/T_0 = \frac{-is}{1 - x(1 - i\sigma)e^{-i\Delta}}, \quad (23)$$

where the transmission ratio per layer, x , is the solution of

$$x^2 + 1 = \left[\frac{s\bar{s}e^{-i\Delta} + (1 - i\sigma)^2 e^{-i\Delta} + e^{i\Delta}}{(1 - i\sigma)} \right] x. \quad (24)$$

The parameter x can be eliminated and a relatively simple and accurate analytical expression for S_0/T_0 can be obtained from Eqs. (23) and (24) for two important general cases:

Case 1, non-Bragg reflection for d/λ small compared with unity, and $\Delta = \epsilon$, and

Case 2, Bragg reflection region for which $\sin \theta \approx m\lambda/2d$, and we may write

$$\Delta = m\pi + \epsilon, \quad (25)$$

where in either case, we assume that $\epsilon \ll 1$. First-order Bragg reflection then corresponds to $m = 1$, second-order reflection to $m = 2$, etc. Formally, non-Bragg reflection (Case 1) then corresponds to $m = 0$ or a "zero-order reflection."

Substitution of Δ as expressed in Eq. (25) into Eqs. (23) and (24) leads to the Darwin-Prins result for S_0/T_0 ,

$$\frac{S_0}{T_0} = \frac{-s}{(\sigma + \epsilon) \pm \sqrt{(\sigma + \epsilon)^2 - s\bar{s}}}, \quad (26)$$

in which the plus or minus sign is chosen so that the modulus of S_0/T_0 squared, i.e., I/I_0 , is less than unity. And for x ,

$$x = (-1)^m \exp(-\eta) \quad \text{and} \quad \eta = \pm \sqrt{s\bar{s} - (\sigma + \epsilon)^2}, \quad (27)$$

where the sign is chosen for η such that it has a positive real part so that the wave is attenuated as it propagates through the solid.

These general relations which describe in terms of MF values both non-Bragg ($d/\lambda \ll 1$) and Bragg reflection ($d/\lambda \approx m/2 \sin \theta$) are applied to special cases of practical interest in Sections III and IV.

C. Reflection and Transmission for a Finite Slab of N Layers

We now derive the general equations for reflection and transmission for a slab of finite thickness, $t = Nd$, in terms of the variables S_0/T_0 and x derived above for the infinitely thick system.

The amplitude reflection ratio at the N th layer, corresponding again to a boundary at a semi-infinite solid, must also be S_0/T_0 , but now the downward-progressing wave includes multiple reflection contributions from the N layers above this boundary which are accounted for through the transmission per layer parameter, x . Therefore, the upward-propagating wave amplitude at the N th layer must be $S_0 x^N$ as depicted in Fig. 6A. In order to obtain the reflection ratio for a finite multilayer of N layers, we need to eliminate the boundary condition resulting from the effect of the wave interaction of the infinite multilayer below the N th layer. Let us reverse the roles of downward and upward waves in Fig. 6A by inverting the reflection geometry in Fig. 6A as shown in Fig. 6B. Now by multiplying each boundary wave amplitude indicated in Fig. 6B by the same constant factor, $S_0 x^N/T_0$, we obtain another consistent set of values for the boundary wave amplitudes, as depicted in Fig. 6C, with an incident wave from below of amplitude $S_0 x^N$ and which is now identical to that in Fig. 6A.

We next subtract, by a superposition, the two boundary wave solutions depicted in Figs. 6A and 6C, obtaining the resulting boundary amplitudes indicated in Fig. 6D and, with the net upward-propagating wave at the lower boundary equal to zero, the required boundary condition for the finite slab of N layers.

Finally, by dividing each amplitude in Fig. 6D by the incident amplitude, $T_0(1 - (S_0/T_0)^2 x^{2N})$, we obtain the amplitude ratios for reflection and for transmission:

$$S_{0N}/T_0 = S_0/T_0 \left[\frac{1 - x^{2N}}{1 - (S_0/T_0)^2 x^{2N}} \right] \quad (28)$$

and

$$T_{0N}/T_0 = \frac{[1 - (S_0/T_0)^2] x^N}{1 - (S_0/T_0)^2 x^{2N}}. \quad (29)$$

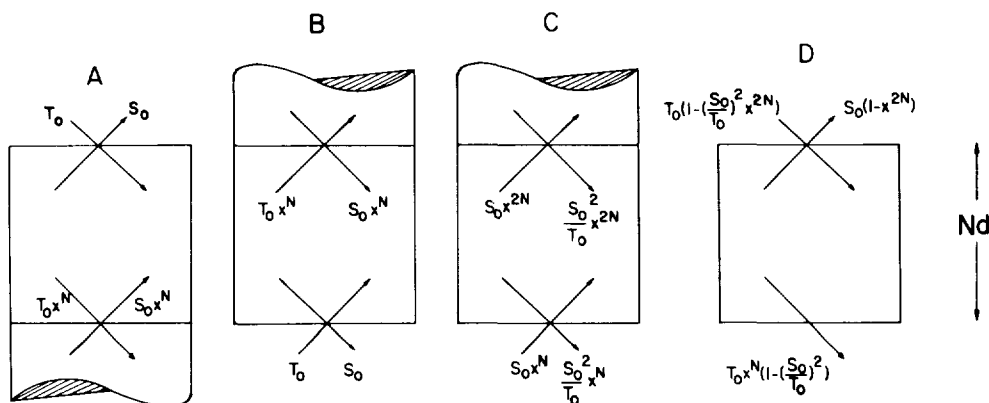

Figure 6. Illustrating the superposition of particular solutions of the Darwin-Prins model for the semi-infinite multilayer to yield the reflected and transmitted amplitude ratios for a finite multilayer of N layers as are included here in a modified Darwin-Prins model.

D. Calculation of the Coherently Transmitted and Reflected Radiation Intensities

The reflected intensity will depend upon whether the radiation source is plane or elliptically polarized (for example, from synchrotron radiation sources) or unpolarized (for example, from an x-ray tube source). For example, the general expression for the reflected intensity from a semi-infinite mirror, multilayer, or crystal analyzer may be written

$$I = T_{0\pi}^2 (S_0/T_0)_\pi^2 + T_{0\sigma}^2 (S_0/T_0)_\sigma^2, \quad (30)$$

in which $T_{0\pi}$ and $T_{0\sigma}$ are the incident amplitude components that are polarized parallel and perpendicular to the plane of reflection, respectively, and $(S_0/T_0)_\pi$ and $(S_0/T_0)_\sigma$ are obtained from Eq. (26) by letting the polarization factor $P(2\theta)$, in s and \bar{s} , be $\cos 2\theta$ or unity, respectively.

For unpolarized radiation sources, the reflection intensity ratio becomes simply

$$I/I_0 = \left(\frac{1}{2}\right) [(S_0/T_0)_\pi^2 + (S_0/T_0)_\sigma^2]. \quad (31)$$

E. Estimation of the Incoherently Scattered Radiation Intensities

The basic interactions described above are the result of coherent scattering by atomic electrons that remain in their initial, bound energy states and therefore the scattered energy of the photons is unchanged. When, however,

the photon energies are large compared with the atomic binding energies, the scattering electrons may recoil into higher energy continuum states and, depending upon the scattering angle, the wavelength of the incoherently scattered radiation is somewhat increased. This is defined as *Compton scattering*.

In the discussions above we have calculated reflected and transmitted intensities by uniform solids by summing first the amplitudes coherently reflected by planes of atoms from which the intensity is determined. To calculate the intensity that is incoherently scattered by this solid we must simply sum the intensities from individual atoms considering that each will scatter independently without any reinforcement of the total intensity in a particular direction. Outside the angular regions of diffraction peaks the incoherently scattered background radiations may become very significant, particularly for systems containing the lighter elements and at the higher photon energies of interest here.

We now develop a formula for estimating the incoherently scattered intensity including that for the important cases of back-scattering and of the background radiation in the vicinity of reflected maxima. As depicted in Fig. 7, a parallel beam of x rays of intensity I_0 is incident at angle θ upon a uniform solid sample of thickness t and of sufficient extent to intercept this beam's cross section S . The number of incoherently scattered photons/s that reach a detector at scattering angle 2θ and exit angle θ is obtained by integrating through the depth of the sample the intensity contributions from differential layers of thickness dz and area $S/\sin \theta$. We assume here that the effective scattering volume and the detector window area

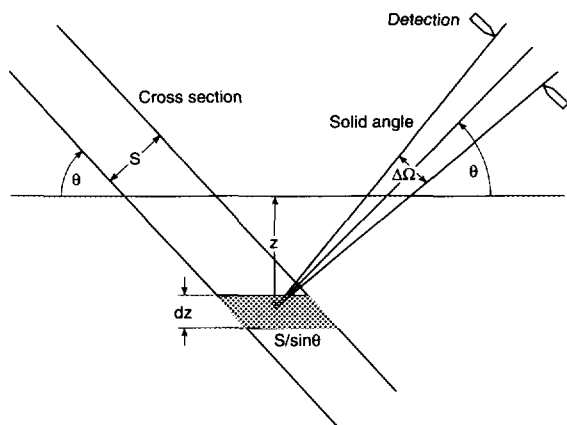

Figure 7. Geometry for the estimation of the single scattering contribution of incoherently scattered radiation at angle 2θ into a small solid angle $\Delta\Omega$ accepted by the detector window and from a small sample volume of thickness dz .

are of sufficiently small extent that the small solid angle accepted by the detector, $\Delta\Omega$, is essentially the same for all scattering atoms. (Because incoherently scattered background is usually small, we consider single scattering only to be significant.) It is also assumed at this point that the sample is composed of the same atoms of atomic density n atoms per unit volume. As is discussed in the Appendix the differential cross section per unit solid angle for incoherent scattering of unpolarized x radiation may be given by the approximate relation

$$\left(\frac{d\sigma}{d\Omega}\right)_{\text{inc}} = r_0^2 \left(\frac{1 + \cos^2 2\theta}{2}\right) \left(Z - \frac{f_0^2}{Z}\right). \quad (32)$$

Here the first factor is the differential cross section per unit solid angle for the Thomson scattering intensity from a classical free electron (r_0 is the classical electron radius, e^2/mc^2). For polarized incident beams (for example, synchrotron radiation) the polarization factor $(1 + \cos^2 2\theta)/2$ may be replaced by unity or $\cos^2 2\theta$ when the incident electric vector is perpendicular or parallel to the plane of reflection, respectively. For the light elements at the higher photon energies for which Compton scattering may become significant, the atomic scattering factor, $f_1 + if_2$, becomes essentially equal to f_0 , the well-tabulated atomic form factor.^{7,8} f_0 is a function of $(\sin \theta)/\lambda$, which is equal to Z for forward scattering or for low-energy x rays and rapidly approaches zero value for large scattering angles at the higher photon energies.¹⁻⁵

The transmission factor at depth z for the incident and exit paths within the sample may be given as

$\exp(-2\mu_{\text{t}}z/\sin \theta)$, where μ_{t} is the linear attenuation coefficient (defined below). The integral for the number of photons per second, N , that are incoherently scattered at angle 2θ and to the detector becomes

$$N = \frac{I_0 n S}{\sin \theta} \left(\frac{d\sigma}{d\Omega}\right)_{\text{inc}} \Delta\Omega \int_0^t \left[\exp\left(-\frac{2\mu_{\text{t}}z}{\sin \theta}\right)\right] dz, \quad (33)$$

which yields for a sample of finite thickness t

$$\frac{N}{I_0 S} = \frac{r_0^2 n}{2\mu_{\text{t}}} \left(Z - \frac{f_0^2}{Z}\right) \left(\frac{1 + \cos^2 2\theta}{2}\right) \times \left[1 - \exp\left(-\frac{2\mu_{\text{t}}t}{\sin \theta}\right)\right] \Delta\Omega. \quad (34)$$

If there is more than a single type of atom composing the sample then the two material quantities, $n(Z - f_0^2/Z)$ and μ_{t} , are simply replaced by summations

$$\sum_q n_q (Z_q - f_{0q}^2/Z_q) \quad \text{and} \quad \sum_q n_q \mu_{\text{t}q}, \quad (35)$$

where n_q , Z_q , f_{0q} , and $\mu_{\text{t}q}$ are the atomic density, atomic number, atomic form factor, and total atomic cross section for the q -type atom, respectively.

Note that for monochromatic incident x radiation the incoherently scattered x rays at a given angle of scattering will have a somewhat broadened distribution in wavelength centered at a wavelength slightly longer than that of the incident radiation. This shift in wavelength depends only upon the angle of scattering, 2θ , and is equal to $\lambda_c(1 - \cos 2\theta)$, where $\lambda_c = h/mc = 0.02426 \text{ \AA}$, the Compton wavelength.

For the light elements and for photon energies that are large compared to their electronic binding energies the total cross section for incoherent scattering must be added to the photoabsorption cross section μ_{a} , to yield the total atomic attenuation cross section, μ_{t} as employed above to properly define x-ray beam transmission at the non-Bragg reflecting angles. Generally the coherent scattering contribution to the attenuation of the transmitted beam (extinction) is negligible for the uniform absorber at non-Bragg angles outside the small-angle total reflection region. There can be sample structure-dependent coherent scattering of energy out of the transmitted beam direction, for example, by nonuniformities such as small particles or holes, which would need to be considered as a special case.⁹ Also there may be strong coherent scattering extinction contributions to the attenuation for special beam geometries, for example, in total reflection and in Bragg reflection (which are separately treated in Sections III and IV).

The total incoherent atomic cross section is obtained by multiplying the differential cross section given above by the solid angle, $d\Omega = 2\pi(\sin 2\theta)d(2\theta)$ and in-

tegrating from θ equal to zero to $\pi/2$. This yields the expression

$$\sigma_{\text{inc}} = 2\pi r_0^2 \int_0^{\pi/2} d\theta (\sin 2\theta)(1 + \cos^2 2\theta) \times (Z - f_0^2/Z). \quad (36)$$

Because the differential solid angle in this integral includes all scattering planes, this result is independent of the polarization state of the incident beam.

The integral has been numerically evaluated using the analytical expression for the form factor, f_0 , given in

III. NON-BRAGG DYNAMICAL REFLECTION AND TRANSMISSION BY MULTILAYERS

There are two often applied x-ray measurements, foil transmission and small-angle mirror reflection, that can be analyzed with equal accuracy using either the electromagnetic boundary value solutions or the atomic scattering solutions given above. It is of interest to demonstrate the equivalence of the optical electromagnetic and the modified Darwin-Prins (MDP) solutions for these cases in which the scattering angles are small and/or the wavelengths are large and the optical constants, δ and β , are therefore applicable.

A. Non-Bragg Reflection at Normal Incidence for a Semi-Infinite Solid

We consider first the normal incidence reflection from a smooth surface of a uniform semi-infinite solid with the non-Bragg condition $d/\lambda \ll 1$, and therefore $s = \bar{s}$. With $\lambda \gg d$, it follows that the scattering factors are angle independent and the optical constants, δ and β , may be defined as in Eqs. (17) and (18). And with Eqs. (11) and (12) we note that $|s| = |\sigma|$. Therefore, for normal incidence reflection and transmission,

$$s = \sigma = -\frac{2\pi d}{\lambda} (\delta + i\beta). \quad (37)$$

Now by multiplying the numerator and denominator by $(\lambda/2\pi d)$ in the normal incidence reflection amplitude ratio S_0/T_0 given in Eq. (26) and letting $\epsilon\lambda/2\pi d$ be replaced by unity, we obtain to lowest order in δ and β

$$S_0/T_0 = (1/2)(\delta + i\beta). \quad (38)$$

This is in agreement with the familiar OEM Fresnel reflection result $S_0/T_0 = (n_r - 1)/(n_r + 1)$ since δ and β may be neglected compared with unity. The intensity ratio for a normal incidence reflection, I/I_0 (for all polarizations of the incident beam), is obtained by multiplying S_0/T_0 in Eq. (38) by its complex conjugate

$$I/I_0 = (1/4)(\delta^2 + \beta^2). \quad (39)$$

Ref. 8 and yielding a table, presented in Table II for the incoherent cross sections (cm^2/g) for the light elements, $Z = 2$ to 18, and for the photon energies that are large compared to their electronic binding energies. Also the total cross section for attenuation through uniform samples at non-Bragg angles, $\mu_t = \mu_a + \mu_{\text{inc}}$, has been plotted in Table I (as a dashed curve) along with the photoabsorption cross section, μ_a , for the light elements, $Z = 1$ to 18. Again, this total cross section cannot include the special extinction effects introduced by small-angle reflection or by Bragg or nonuniform sample diffraction.

Again, since for normal incidence $\epsilon = 2\pi d/\lambda$, requiring that $|s| \ll \epsilon$ from Eq. (37), the value for the transmission per layer within the semi-infinite block, x , becomes from Eq. (27) with $m = 0$

$$x = e^{-\eta}, \quad \eta = i(\epsilon + \sigma). \quad (40)$$

B. Non-Bragg Reflection and Transmission at Normal Incidence for an N -Layer System

1. Relating $f_2(0)$ and β to Photoabsorption Cross Sections

Since the optical constants, δ and β , are in the range 10^{-2} to 10^{-6} for the x-ray region, the amplitude reflection ratio at normal incidence, S_0/T_0 , is noted from Eq. (38) also to be very small. Relations (28) and (29) for the reflection and transmission at normal incidence for an N -layer system become (after second-order terms in S_0/T_0 are dropped) using Eqs. (38) and (40)

$$\begin{aligned} \frac{S_{0N}}{T_0} &= \left(\frac{S_0}{T_0} \right) (1 - x^{2N}) \\ &= \frac{\delta + i\beta}{2} (1 - e^{-i2N(\epsilon + \sigma)}) \end{aligned} \quad (41)$$

and

$$\frac{T_{0N}}{T_0} = x^N = e^{-iN(\epsilon + \sigma)} = e^{-i2\pi Nd(1 - \delta - i\beta)/\lambda}. \quad (42)$$

We confirm in Eq. (42) that the phase change upon passing through an N -layer block is $-2\pi Nd(1 - \delta)/\lambda$. By squaring the modulus of T_{0N}/T_0 , we obtain the transmitted intensity ratio that defines the attenuation cross sections, viz.

$$I/I_0 = e^{-4\pi\beta Nd/\lambda} = e^{-\mu t} = e^{-\mu_m m}. \quad (43)$$

Here the mass per unit area is given by $m = \rho t$, where ρ is the mass density, and we have introduced the mass

absorption coefficient, $\mu_m = \mu_1/\rho$. We therefore find for a perfectly uniform, non-Bragg transmitting foil system, using Eq. (18), the relations for the linear absorption coefficient, μ_1 :

$$\begin{aligned}\mu_1 &= \rho\mu_m = \frac{4\pi\beta}{\lambda} = \frac{2r_0\lambda}{d} MF_2(0) \\ &= 2r_0\lambda \sum_q n_q f_{2q}(0) = \sum_q n_q \mu_{aq}.\end{aligned}\quad (44)$$

From the above MDP description of a non-Bragg normal incidence transmission through an ideally uniform absorber we obtain the result that

$$f_{2q} = \mu_{aq}/2r_0\lambda = (\pi/2)CE\mu_{aq},\quad (45)$$

where E is the incident photon energy, $C = (\pi r_0 hc)^{-1} = 0.9111 \text{ (eV } \text{\AA}^2)^{-1}$, h is Planck's constant, and c is the velocity of light. This is the basis for our determination of the f_2 component of the atomic scattering factors from measured photoabsorption data assuming uniform non-diffracting absorbers in which incoherent scattering is negligible. This same relation between the atomic scattering-factor component, f_2 , and the atomic photoabsorption cross section, μ_a , is derived in the Appendix using the Kramers-Kronig theoretical model.

Note that in the discussions that follow we refer to the mass photoabsorption coefficient as simply μ .

We may also obtain from Eqs. (44) and (45) the expressions that relate the average energy per photon that is photoelectrically absorbed per unit path length at the surface of a solid, $E\mu_1$, to the atomic scattering-factor components, f_{2q} :

$$E\mu_1 = \frac{2}{\pi C} \sum_q n_q f_{2q}(0).\quad (46)$$

An important application of this is the prediction of an x-ray photocathode's secondary-electron emission yield, Y_s , defined as the number of secondary electrons produced per incident photon. Since the mean escape depth, L , of the secondary electrons within a given material is usually small compared with the x-ray attenuation length, Y_s is simply proportional to the total energy absorbed within the escape depth,

$$Y_s = KLE\mu_1 = \frac{2KL}{\pi C} \sum_q n_q f_{2q}(0),\quad (47)$$

where K depends upon the photocathode material. Thus, the energy dependence of Y_s is proportional to the atomic scattering-factor components, f_{2q} , as has been experimentally demonstrated in Ref. 10. Also as suggested by Eq. (47), a measurement of the electron yield versus the incident photon energy will reflect the absorption edge structures of the f_{2q} components that are characteristic of the surface layers of a sample, typically within a few hundred angstroms. This fact has been extensively utilized in the electron yield detection of EXAFS spectra.¹¹

2. Transmission Measurement of Photoabsorption Cross Sections

As is described in Section VI and in the Appendix the basic atomic scattering components, $f_1(0)$ and $f_2(0)$, which are tabulated in this work have been derived from the atomic photoabsorption cross sections. These may be accurately determined from normal incidence transmission measurements *provided that the sample is a uniform, nondiffracting distribution of atomic or molecular scattering units*. For such a sample the amount of coherently scattered energy outside the transmitted beam direction can be considered negligible and therefore a total measured cross section per unit mass, μ_t , will be given by

$$\mu_t = \frac{\ln(I_0/I)}{m} = \mu + \mu_{inc},\quad (48)$$

where m is the mass per unit area (g/cm^2) of the foil and μ and μ_{inc} are the photoabsorption and incoherent scattering cross sections, respectively. We may then obtain the mass photoabsorption cross section by

$$\mu = \frac{\ln(I_0/I)}{m(1 + \mu_{inc}/\mu)},\quad (49)$$

where the correction for incoherent scattering, μ_{inc}/μ , may be obtained from the appended tables for μ_{inc} and μ as has been discussed in Section II.E. This correction is negligible except for the lightest elements and higher photon energies.

Finally we can express this measured photoabsorption cross section, μ , as a simple sum of the atomic photoabsorption contributions provided that the atoms are absorbing independently in the condensed state of the absorber—which, as discussed in Section VII, is usually the case for photon energies above about 50 eV and outside the absorption edge thresholds. The measured mass photoabsorption cross section, μ , may then be expressed by the relation

$$\mu = \frac{N_A}{M_r} \sum_q x_q \mu_{aq},\quad (50)$$

where N_A is Avogadro's number, M_r is the molecular weight, x_q is the number of q -type atoms per molecule, and μ_{aq} is the atomic photoabsorption cross section of the q -type atom.

Note that it is essential, for a given wavelength, that energy not be diffracted out of the beam direction and detector window as a result of sample structure (for example, crystalline or imbedded particles or holes of d spacings or dimensions comparable with the wavelength). If sample uniformity is questionable, on- and off-axis large-window detector measurements may be compared to a small-window measurement that embraces only the collimated transmitted beam as a basis for estimating measurement error resulting from diffraction effects.

C. Non-Bragg Fresnel Reflection at Small Angles for the Semi-Infinite Solid

1. Reflection from an Ideally Smooth Surface

We now apply Eq. (26) to the special case of non-Bragg reflection at small angles of grazing incidence from a perfectly smooth semi-infinite mirror surface with the incident beam's electric vector *perpendicular* to the plane of incidence (σ polarization, with $P(2\theta) = 1$). Again, for $d/\lambda \ll 1$, we may let $s = \bar{s}$ (independent of any unit cell asymmetry). And for small angle reflection, essentially only forward scattering is involved and therefore we may let $s = \bar{s} = \sigma$ in Eq. (26) and obtain

$$\frac{S_0}{T_0} = \frac{-\sigma}{\epsilon + \sigma + \sqrt{\epsilon^2 + 2\epsilon\sigma}}. \quad (51)$$

Multiplying the numerator and denominator of Eq. (51) by $\lambda(\sin \theta)/(2\pi d)$, we obtain, using Eqs. (16) to (18), the small-angle reflection for a σ -polarized beam in terms of the optical constants, δ and β , which again are applicable for this case of essentially forward scattering:

$$\frac{S_0}{T_0} = \frac{\delta + i\beta}{\sin^2\theta - (\delta + i\beta) + \sin \theta \sqrt{\sin^2\theta - 2(\delta + i\beta)}}. \quad (52)$$

Now from James¹ (see his Eq. 4.84) the optical electromagnetic Fresnel equation for small-angle, σ -polarized radiation reflection, S_0/T_0 , is

$$\frac{S_0}{T_0} = \frac{\sin \theta - \sqrt{\sin^2\theta - 2(\delta + i\beta)}}{\sin \theta + \sqrt{\sin^2\theta - 2(\delta + i\beta)}}. \quad (53)$$

Finally, to demonstrate the equivalence of Eq. (53) to our MDP result, Eq. (52), we multiply the numerator and denominator of Eq. (53) by its denominator and obtain identically Eq. (52).

In Ref. 12, a derivation is outlined for the general relations for x-ray reflection and a convenient expression is given for the reflected intensity of a σ -polarized beam, which is

$$\frac{I_\sigma(\theta)}{I_0} = \frac{\rho^2(\sin \theta - \rho)^2 + \beta^2}{\rho^2(\sin \theta + \rho)^2 + \beta^2}, \quad (54)$$

and for the ratio of the intensities reflected by the π - and the σ -polarized beams,

$$\frac{I_\pi(\theta)}{I_\sigma(\theta)} = \frac{\rho^2(\rho - \cos \theta \cot \theta)^2 + \beta^2}{\rho^2(\rho + \cos \theta \cot \theta)^2 + \beta^2}, \quad (55)$$

where ρ is given by

$$\rho^2 = (1/2)[\sin^2\theta - 2\delta + \sqrt{(\sin^2\theta - 2\delta)^2 + 4\beta^2}]. \quad (56)$$

With Eqs. (30), (54), and (55) one may obtain the reflected intensity, I , for incident beams of any polarization. For example, for an unpolarized incident beam, I becomes

$$I = I_\sigma(1 + I_\pi/I_\sigma)/2. \quad (57)$$

Reflectivity curves have been calculated using the relations given above for appropriate angles of incidence and photon energies and are presented in Table III for 10 ideally smooth x-ray mirror surfaces: Be, C, Al, Al₂O₃, SiO₂, Ni, Cu, Mo, Pt, and Au.

2. Effect of Surface Structure upon Mirror Reflectivity

Mirror surface structure may cause a significant change in the shape of the total reflection cutoff region from that predicted by the Fresnel reflection described above. Such a change may represent an important source of error, for example, in the design of mirror monochromators or in the experimental determination of $f_1(0)$ and $f_2(0)$ (or equivalently, δ and β) from the reflectivity curve.

Often the measured deviation from a Fresnel characteristic cutoff with reflection angle or photon energy can suggest the nature of the surface structure that caused it. We briefly review here methods for modifying the Fresnel reflection response for three types of surface structure.

1. The reflectivity may be calculated for the surface or interface for which the density and/or optical constants vary with depth. As noted earlier, if surface roughness features are of areal dimensions that are small compared with those of the Fresnel half-period zones within a differential reflecting layer (see Section II.A), their structure may be modeled as an interface density that varies with depth.¹³

2. If the roughness structures are not small compared with the Fresnel half-period zones, their low-angle diffraction will broaden the Fresnel cutoff characteristic.¹⁴

3. Often, as a result of its fabrication, a mirror surface may have a cross section in the plane of reflection that may be Fourier analyzed as a sum of sinusoidal waves of lengths that are very large compared to Fresnel zone dimensions. The specularly reflected amplitudes can be calculated for a sinusoidal surface of particular amplitude and length. A sum of such reflection amplitudes can then be obtained for the set of Fourier components that approximate the surface waviness.^{14,15}

IV. BRAGG DYNAMICAL REFLECTION AND TRANSMISSION BY MULTILAYERS

We define *multilayers* in this work as any periodic system of layered structures that are parallel to the reflect-

ing surface (see Fig. 3). Nearly all practical x-ray analyzers, natural crystals, and Langmuir-Blodgett (LB), and sput-

tered-or-evaporated (S/E) constructed systems are multilayers as defined here. Hence the reflection by a semi-infinite multilayer may be described by Eqs. (26) and (27), and the reflection and transmission of a multilayer of finite thickness may be described by Eqs. (28) and (29). These analytical solutions yield accurate descriptions in the vicinity of Bragg reflection profiles of orders $m = 1, 2, 3, \dots$ for the first-, second-, third-order, etc., reflections—assuming that for the x-ray region the interaction parameters per layer, $|\sigma|$ and $|s|$, are small compared with unity. (Note that for practical analyzers, the interaction per layer is necessarily small in order to have the participation of a large number of reflecting planes to assure good spectral resolution, as discussed in Ref. 6.)

Inside the multilayer, the angle of incidence and the wavelength at a plane of unit cells may need to be corrected for refraction shifts. The angle after refraction, θ' , and the modified wavelength, λ' , which must be used in the description of the wave interference within the multilayer's unit cell (defined by the MF values), are given by Snell's law, $\cos \theta / \cos \theta' = 1 - \delta = \lambda / \lambda'$. We use here only the real part of the refractive index, $1 - \delta$, because it can be easily shown that for x-ray refraction effects, the first-order terms in β cancel. In our model description of multilayers in the low-energy x-ray region where refraction effects become relatively large, we replace the ratio $(\sin \theta) / \lambda$, which appears in the unit cell structure factor, F , by $(\sin \theta') / \lambda'$. In terms of the optical constant, δ , we may easily obtain from Snell's law the relation

$$\frac{\sin \theta'}{\lambda'} \approx \frac{\sin \theta}{\lambda} \sqrt{1 - \frac{2\delta}{\sin^2 \theta}}. \quad (58)$$

The basic analytical equations presented above require for a given photon energy or wavelength only the d spacing and the unit area structure factor, MF , for their evaluation. A general expression for MF has been given in Eq. (10). We now present specific examples of the MF functions with appropriate parameterization which may then be applied to yield efficient, analytical, semiempirical characterizations of practical multilayers.

We have developed small-computer programs¹⁶ that efficiently calculate the reflectivity characteristics of multilayers defined by the MF parameters. Also available are computer programs for the successive application of the Fresnel reflection equations at each interface boundary within the multilayer (from the last to the first),^{17,18} in order to obtain the reflectivity characteristics using the OEM approach applicable when the layers may be accurately defined by the optical parameters δ and β (for example, for the longer wavelengths and/or the small reflection angles for which the form factor corrections are negligible).

It is necessary to use the OEM and not the MDP approach when the Bragg reflection occurs at very small

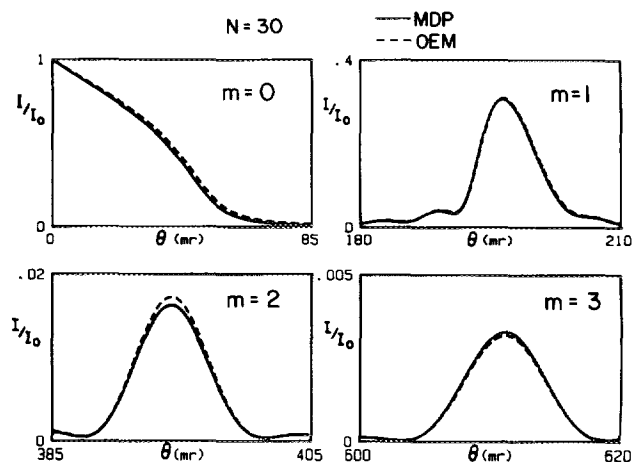

Figure 8. Illustrating the equivalence of the modified Darwin-Prins (MDP) and the optical electromagnetic (OEM) descriptions for low-energy x-ray reflectivity in the small-angle non-Bragg Fresnel reflection region and in the large-angle Bragg reflection regions at the first-, second-, and third-order diffraction line profiles (930-eV/13.3-Å x radiation reflected from 30 layer pairs of 14-Å tungsten and 21-Å carbon with sharp interfaces).

angles, which requires values of the interaction per layer parameters, σ and s , that are not small compared with unity as needed for an accurate MDP solution. In Appendix A in Ref. 6 we have shown that the MDP results, Eqs. (26) through (29), accurately describe Bragg reflection when the first-order reflection angle, θ_1 , is greater than about three times the total reflection cutoff angle, $\theta_c (\approx \sqrt{2\delta})$.

It is of interest to compare the reflectivity curves for the $m = 0, 1, 2$, and 3 regions as calculated by the atomic (MDP) and by the optical (OEM) methods for a case where both approaches are applicable, viz. for a sufficiently long wavelength and with the first-order Bragg reflection well outside the small-angle Fresnel reflection region. In Fig. 8 we compare the small-angle and the first three orders of Bragg reflection as calculated using our MDP and OEM small-computer programs for Cu-L (930 eV, 13.3 Å) radiation from 30 double layers of tungsten-carbon (14 Å of W and 21 Å of C) assuming sharp interfaces. In Fig. 9 we compare the MDP and OEM calculated curves for near-normal incidence reflection in first order from 100 double layers of tungsten-carbon (14 Å of W and 21 Å of C) and for three wavelengths at and near that for a "tuned" maximum reflectivity. The MF values used in these calculated plots were obtained as described below.

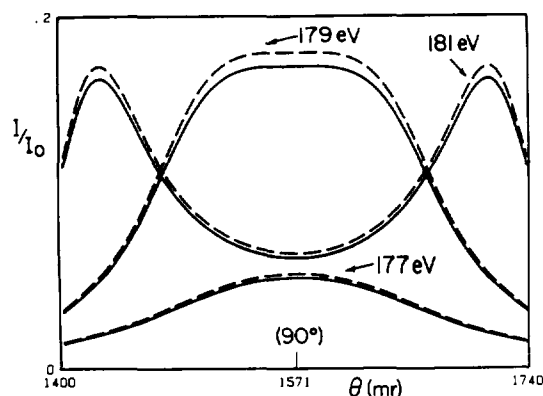

Figure 9. Illustrating the equivalence of the MDP solid line and the OEM dashed line descriptions for low-energy x-ray reflectivity in the near-normal incidence angle region for a first-order Bragg reflection from 100 layer-pairs of 14-Å tungsten and 21-Å carbon with sharp interfaces.

A. MF Values for Natural Crystal Multilayers

As noted earlier, most practical x-ray multilayer analyzers involve unit cells that have a symmetry plane so that the MF value is the same for a reflection from above and from below the unit cell plane and therefore $s = \bar{s}$ in the amplitude reflection equation for S_0/T_0 given in Eq. (26). In our MF results, which are described below for natural crystals and Langmuir–Blodgett analyzers, we have assumed a symmetrical unit cell structure but we assure the reader that it will be straightforward to modify these calculations for the few cases for which the asymmetrical system is of interest.^{6,16} For the symmetrical unit cell we may rewrite Eq. (10), measuring z_q/d 's from the symmetry plane (thereby eliminating the odd sine terms), as

$$MF = M \sum_q g_q f_q \cos\left(\frac{4\pi z_q}{\lambda} \sin \theta\right), \quad (59)$$

in which M is the number of unit cells per unit area and g_q is the number of atoms of type q within the unit cell with coordinate z_q measured from the symmetry plane.

This one-dimensional distribution of g_q at z_q may be obtained from crystallographic data using the following three geometrical relationships. For z_q/d ,

$$z_q/d = hx'_q + ky'_q + lz'_q. \quad (60)$$

For the unit cell volume,

$$V = abc(1 + 2 \cos \alpha \cos \beta \cos \gamma - \cos^2 \alpha - \cos^2 \beta - \cos^2 \gamma)^{1/2}. \quad (61)$$

For the unit cell cross-sectional area, V/d , or M^{-1} ,

$$\begin{aligned} \left(\frac{V}{d}\right)^2 &= (hbc \sin \alpha)^2 + (kac \sin \beta)^2 + (lab \sin \gamma)^2 \\ &+ 2hk(abc^2)(\cos \alpha \cos \beta - \cos \gamma) \\ &+ 2kl(a^2bc)(\cos \beta \cos \gamma - \cos \alpha) \\ &+ 2lh(ab^2c)(\cos \gamma \cos \alpha - \cos \beta). \quad (62) \end{aligned}$$

Here we have applied the conventional parameters which define the *three-dimensional* unit cell, viz. the set of three vectors usually denoted \mathbf{a} , \mathbf{b} , and \mathbf{c} with magnitudes a , b , and c , having the included angles α , β , and γ . The coordinates of the individual atoms relative to this basis set are usually designated x' , y' , and z' (z' is usually different from z as used here).

The specific crystal planes being used are specified by their Miller indices (h, k, l) . Note that for crystals having a hexagonal unit cell, often four-component Miller indices are given; this notation may be converted to Miller indices as applied here by neglecting the third component. A constant may be added to z_q/d to make $z = 0$ correspond to a symmetry plane.

Generally it is necessary to search the crystallographic literature to find these coordinate values. A good source of such data is *Crystal Structures* by Wyckoff.¹⁹ For further help in understanding the notation used, and for a good general reference, see the *International Tables for X-Ray Crystallography*.⁸ Finally for a very helpful consistency check, the mass density of the assumed unit cell should be calculated and compared with the bulk density of the crystal. Bertin²⁰ has published values for d for many practical x-ray analyzing crystals.

In Table IV, we have applied the models described above to a set of 21 practical natural crystal analyzers. The integrated reflectivity is calculated for both the perfect crystal (DP model) and the mosaic crystal (kinematical model described in Section V). The measured integrated reflectivity generally falls between these two extremes. The widths and peak reflectivities are also presented for σ - and π -polarized incident beams for the perfect crystal model. It should be noted that the real crystal may yield substantial differences from these diffraction profile parameters depending upon its imperfections (to which, however, the integrated reflectivity is relatively insensitive).

Only for the natural crystals having the smallest d spacings as required for the reflection of the short wavelengths may the peak reflectivities also be significantly diminished by the effect of thermal vibrations of the crystal lattice. This temperature-dependent reduction of peak intensities is given by the Debye–Waller factor (cf. Ref. 1 or 21).

B. MF Values for Langmuir-Blodgett Multilayers

The LB multilayers are constructed by successively depositing N monomolecular layers of typically a lead or barium salt of a straight-chain fatty acid upon a smooth substrate (for example, float glass or silicon wafer). The resulting multilayer has a periodic structure composed of thin double atomic layers of the heavy cation (for example, Pb or Ba) separated by the low-density, long-carbon matrix providing the desired high x-ray scattering "contrast." The d spacings are set simply by the choice of the straight-chain fatty acids that can be successfully applied to construct high-quality multilayer analyzers. These are, according to our experimental results, in the 35- to 80-Å d -spacing range. (The layers are deposited as the substrate is "dipped" in and out of a water surface on which the insoluble monomolecular compressed layer of the fatty acid salt has been established. The special method, equipment, chemistry and experimental evaluation have been described in detail in Ref. 6.)

The chemical formula for a salt of a straight-chain fatty acid with the required bivalent cation (such as Pb) may be written

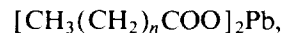

where n is the number of CH_2 groups between an end CH_3 group and the carboxylate. We have measured the absolute spacing of multilayers generated from a series of fatty acids and have found that the d spacing may be closely predicted for a given value of n by

$$d = 2.50(n + 4) \text{ \AA}, \quad (63)$$

which establishes the projected spacing between the CH_2 groups along the molecular z axis to be 1.25 Å. We have used available crystallographic data on fatty acids and on the carboxyl groups to assign positions for the other atoms in the fatty acid molecule.

We have applied Eq. (59) and the d spacings indicated in Fig. 10 and have varied the areal density, M ,

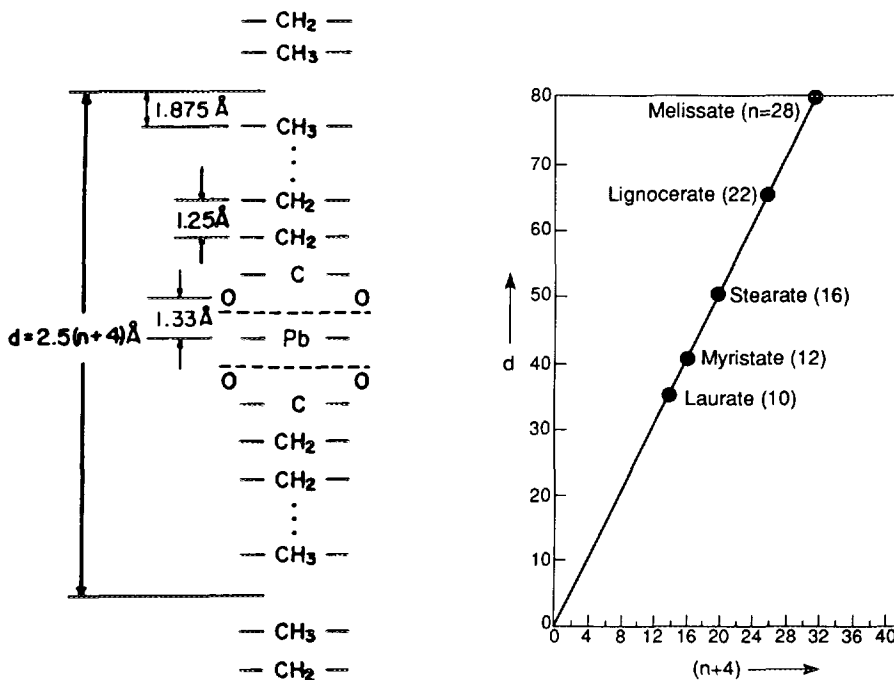

Figure 10. Defining the unit cell for a Pb salt of a straight-chain fatty acid, $[\text{CH}_3(\text{CH}_2)_n(\text{COO})]_2\text{Pb}$. The one-dimensional distribution of atoms within the unit cell that is assumed in our modeling is presented here. We have measured the d spacing for the multilayers generated as salts of the fatty acids to be equal to approximately $2.50(n + 4)$ and the cross-sectional area occupied by a typical Langmuir-Blodgett (LB) layer's unit cell to be about 20.5 \AA^2 .

of the molecules in order to semiempirically fit measured integrated reflectivity data for a series of molecular multilayers in the d -spacing range 35–80 Å. Generally the fitting precision through several diffraction orders was well within experimental error limits. The unit cell area, $1/M$ (the molecular cross section), was determined by this fitting procedure to be about 20.5 \AA^2 .

C. MF Values for Sputtered-or-Evaporated Multilayers

The deposition of multilayers by sputtering of periodically heavily and lightly scattering layers can generate a significantly asymmetric interface structure in the unit cell system. For example, the extent of the interface penetration region resulting from sputtering of the light ions into the preceding heavy layer is normally less than that resulting from sputtering the heavy ions into a light layer. This geometry is depicted in Fig. 11, defining X and Y as the thicknesses of the pure “light” and “heavy” regions and T_1 and T_2 as the thicknesses of the possible transition regions at their interfaces. In order to calculate the MF value for this system, we now express the summation given

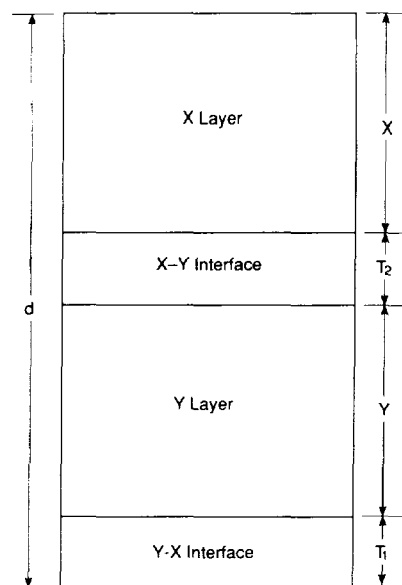

Figure 11. Defining the geometry of a sputtered-or-evaporated (S/E) multilayer's periodic layered structure (cell) of total thickness, d . X and Y are the thicknesses of the pure “light” and “heavy” layers, respectively. T_1 and T_2 are the thicknesses of possible interface transition regions. The d spacing is then $X + Y + T_1 + T_2$.

in Eq. (10) by an integral,

$$MF = \sum_q \int_0^d n_q(z) f_q \exp\left(\frac{i4\pi z}{\lambda} \sin \theta\right) dz, \quad (64)$$

in which $n_q(z)$ is the number per unit volume of atoms of type q at position z from a given reference plane and having an atomic scattering factor f_q .

We present here a practical unit cell model and its corresponding integration of Eq. (64), which we have described as the “linear transition” interface model discussed in detail in Ref. 6 (see also Ref. 22). We define the number densities $n_{x,0}$ and $n_{y,0}$ and the atomic scattering factors f_x and f_y for regions X and Y . In the transition interface regions T_1 and T_2 , it is assumed that the n_x and n_y densities vary linearly from their values of $n_{x,0}$ and $n_{y,0}$ to zero. This simple linear variation of number densities within the interface regions T_1 and T_2 allows a modeling of interdiffusion (for example, a linear approximation of an exponential drop in the penetration densities) and/or interface roughness (for example, of structures that are small compared with the dimensions of the Fresnel half-period reflecting zones as noted earlier).

In Fig. 11 this periodic structure of an S/E multilayer is depicted with the top or last layer deposited as the light layer of thickness X . (Similarly a depiction might be with the heavy Y layer at the top as the last layer that was sputtered or evaporated.) The x-ray reflection intensity from a multilayer of these periodic layered structures will depend significantly upon which type of layer is at the surface only if a small number of reflecting layers are involved. This is the case when the absorption per layer is large for a given wavelength and angle of reflection. Then, as discussed above, the interaction per layer parameters, s and σ , are not small compared with unity as required for the MDP solution and rather the OEM calculation must be applied. This OEM method involves an iterative application of the Fresnel reflection equations at each interface of the system as approximated by a set of discrete layers of different optical constants (see Refs. 16, 17, and 18).

We consider here the calculation of MF values for S/E multilayer analyzers for which the interaction parameters, s and σ , of the unit cell plane are small compared with unity and a relatively large number of these layers participate in its reflectivity. In evaluating the integral in Eq. (64) we have chosen the reference plane ($z = 0$) in the heavy Y layer such that the integration is from $-d/2$ to $+d/2$ in order to simplify the resulting expressions for MF . We assume that the volumes occupied by the component atoms (or molecules), $1/n_{x,0}$ and $1/n_{y,0}$, in the X and Y layers are essentially unchanged within the transition layers T_1 and T_2 . This S/E model yields MF for a reflection of a wave from above this unit cell

plane [needed to define s in Eq. (26)],

$$MF = \frac{n_{x0}f_x d}{\Delta'} \sin(\Delta') + \frac{d}{2\Delta'} (n_{x0}f_x - n_{y0}f_y) \times \left[\frac{e^{-i\Delta'(Y+T_1+T_2)/d}}{2\Delta'(T_1/d)} (1 - e^{i2\Delta'T_1/d}) + \frac{e^{i\Delta'(Y+T_1+T_2)/d}}{2\Delta'(T_2/d)} (1 - e^{-i2\Delta'T_2/d}) \right], \quad (65)$$

where $\Delta' = 2\pi d (\sin \theta')/\lambda'$. For $M\bar{F}$ for the reflection of a wave from below the unit cell plane [needed to define \bar{s} in Eq. (26)], simply interchange T_1 and T_2 in Eq. (65) above.

When the multilayer may be modeled with $T_1 = T_2 = T$, the reference plane, $z = 0$, becomes the symmetry plane and $MF = M\bar{F}$ becomes

$$MF = \frac{n_{x0}f_x d}{\Delta'} \sin(\Delta') + \frac{d^2}{2T\Delta'^2} (n_{x0}f_x - n_{y0}f_y) \times \left\{ \cos\left[\frac{\Delta'(Y+2T)}{d}\right] - \cos\left(\frac{\Delta'Y}{d}\right) \right\}. \quad (66)$$

V. KINEMATICAL APPROXIMATION RELATIONS FOR BRAGG REFLECTION

Many practical x-ray analyzers are *not* perfectly ordered and uniform as assumed in the derivation of the dynamical MDP solution, Eq. (26), and as depicted in Fig. 3. For these systems the contributions of multiple reflections between reflecting planes can be significantly diminished because of high absorption for the lower energy x rays, rough or diffused interface boundaries, and an imperfect, mosaic multilayer structure. In order to include the effect of breaking up the dynamical multiple reflections we introduce a factor κ in Eq. (26) into the term that exclusively introduces the dynamical multiple-reflection contributions, viz. $s\bar{s}$. Then as κ is varied from zero to unity, the description varies from kinematical to dynamical. For the nearly perfect crystal a more accurate description of the diffraction profile might be gained by choosing a value for κ that is somewhat less than unity.

For the imperfect crystal description, letting κ approach zero leads to *integrated* reflectivities (area under the Bragg diffraction profile, R) that may more accurately fit the measured values and are, indeed, equal to those that are predicted also by the ideally imperfect *mosaic crystal model* (see below). This kinematical description cannot, of course, predict the angular widths (for example, the full width at half-maximum) into which the diffracted energy is spread because the measured diffraction line is additionally broadened by the imperfections of the par-

Finally, for multilayers with sharp interfaces, we set $T = 0$ in Eq. (66) and obtain

$$MF = \frac{n_{x0}f_x d}{\Delta'} \left[\sin(\Delta') - \sin\left(\frac{\Delta'Y}{d}\right) \right] + \frac{n_{y0}f_y d}{\Delta'} \sin\left(\frac{\Delta'Y}{d}\right). \quad (67)$$

With the MF values given by these equations, the MDP equation (26) for S_0/T_0 may be analytically evaluated to determine, for example, the effect of T_1 and T_2 and of the ratio Y/X upon the reflectivity and resolution of a multilayer type of given d spacing. In Ref. 6 we have applied a procedure for the determination of T_1 and T_2 from experimental integrated reflectivity data for a series of practical sputtered multilayers. With these values, detailed reflectivity characteristics were calculated for similar multilayers with optimized Y/X and d values for the appropriate photon energy regions of application.

tical Bragg analyzer and by the instrumental resolution. Nevertheless we do expect the relative total diffraction line intensity to be insensitive to the Bragg analyzer's imperfection and instrumental broadening effects. This integrated reflectivity, measured by R , is proportional to the product of the peak height, $I(0)/I_0$, and the full width at-half-maximum (FWHM), ω , for the diffraction line profile (defined in Fig. 12).

We now present the analytical equations for the kinematical approximation description of the imperfect multilayer given by setting κ equal to zero. Dropping the $s\bar{s}$ term in Eq. (26) leads to a considerably simplified analytical expression for S_0/T_0 ; viz.,

$$S_0/T_0 = -s/[2(\sigma + \epsilon)]. \quad (68)$$

In order to obtain the reflected intensity we multiply the numerator and denominator in Eq. (68) by their respective complex conjugates; that is,

$$I/I_0 = |s|^2/(4|\sigma + \epsilon|^2).$$

Using Eqs. (11), (12), and (16) we obtain for $|s|^2$

$$|s|^2 = r_0^2 \lambda^2 \frac{P^2(2\theta)}{\sin^2 \theta} |MF(\theta)|^2, \quad (69)$$

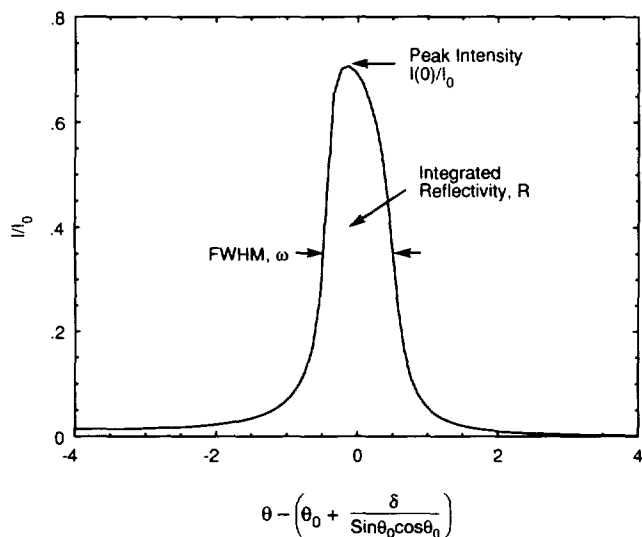

Figure 12. Defining for the diffraction line profile the peak intensity, $I(0)/I_0$, the full-width-at-half-maximum width (FWHM), ω , and the integrated reflectivity, R (area under the diffraction line profile).

and for $|\sigma + \epsilon|^2$ we obtain

$$|\sigma + \epsilon|^2 = \left(\frac{2\pi d}{\lambda}\right)^2 \times \left| \sin \theta - \sin \theta_0 - \frac{\delta + i\beta}{\sin \theta} \right|^2$$

$$\approx \left(\frac{2\pi d \cos \theta_0}{\lambda}\right)^2 \times \left[\left(\Delta\theta - \frac{\delta}{\sin \theta_0 \cos \theta_0} \right)^2 + \left(\frac{\beta}{\sin \theta_0 \cos \theta_0} \right)^2 \right], \quad (70)$$

where $\sin \theta_0 = m\lambda/2d$. We have assumed that $\sin \theta$ varies only a small amount from $\sin \theta_0$ through the effective angular width of the diffraction line so that

$$\sin \theta - \sin \theta_0 \cong \cos \theta_0 (\Delta\theta),$$

where $\Delta\theta = \theta - \theta_0$.

Now by dividing Eq. (69) by (70) we obtain a *Lorentzian* reflection intensity,

$$I(\alpha)/I_0 = \frac{R_1(\omega/2\pi)}{\alpha^2 + (\omega/2)^2}, \quad (71)$$

where α is the angle measured from the refraction-shifted peak position and is given by

$$\alpha = \theta - \left(\theta_0 + \frac{\delta}{\sin \theta_0 \cos \theta_0} \right). \quad (72)$$

Note that the increase in the angle of Bragg reflection because of refraction is derived here to be $\delta/(\sin \theta_0 \cos$

$\theta_0)$, which is also the result given by Snell's law for x rays to within first-order terms in δ and β .

The integrated reflectivity, R_1 , is defined in Eq. (71) as the integral of this Lorentzian over the extent of a diffraction line profile. After dividing Eq. (69) by (70) and with the help of Eq. (44), we may obtain for R_1

$$R_1 = \frac{\pi}{2} \omega I(0)/I_0 = \frac{r_0^2 \lambda^3 P^2(2\theta_0)}{2\mu_1 d^2 \sin 2\theta_0} |MF(\theta_0)|^2. \quad (73)$$

For a polarized incident beam (as from a synchrotron radiation source), the factor $P(2\theta)$ may be replaced by unity for σ polarization and by $\cos 2\theta$ for π polarization. For an unpolarized incident beam (as from a conventional x-ray tube), the factor $P^2(2\theta_0)$ should be replaced by its average value, that is, $(1 + \cos^2 2\theta_0)/2$.

The intrinsic FWHM, ω_0 , follows from this kinematical approximation by

$$\omega_0 = \frac{\mu_1 \lambda}{2\pi \sin \theta_0 \cos \theta_0} = \frac{\mu_1 d}{m\pi \cos \theta_0}. \quad (74)$$

Now if we can assume, with sufficient accuracy, that the line-broadening distributions for imperfection structures and for instrumental collimation are also Lorentzian, their fold with Eq. (71) simply yields another Lorentzian distribution with the same integrated reflectivity, R_1 , but with a lower peak intensity and with a FWHM, ω , given by the sum of the Lorentzian FWHMs, $\omega_0 + \omega_m + \omega_c$, where ω_m and ω_c are the imperfection (for example, mosaic) and instrumental (for example, collimation) broadening distribution FWHM widths.

Then, we obtain for the reduced peak reflectivity

$$I(0)/I_0 = 2R_1/\pi(\omega_0 + \omega_m + \omega_c). \quad (75)$$

Note that if either or both the imperfection and the instrumental resolution broadening functions are significantly better described as Gaussian rather than as Lorentzian, the fold with Eq. (71) becomes a *Voigt* distribution, for which an analytical approximation has been described elsewhere.²³

Finally, we compare this kinematical approximation for the integrated reflectivity R_1 with that obtained for the ideally imperfect or *mosaic* multilayer R_m . The mosaic multilayer is assumed to be broken up into a large-number mosaic of small well-ordered crystalline domains that individually reflect coherently but with a random phase relationship with the other reflecting segments of the multilayer. Conventionally, the mosaic quality is attributed to crystallites which are of small lateral dimensions as well as small thickness and with their reflecting planes slightly and randomly deviating from being parallel to the multilayer surface (see Fig. 13). As suggested above, a diffraction line broadening will result from the random orientation of the crystallites as well as from the limited

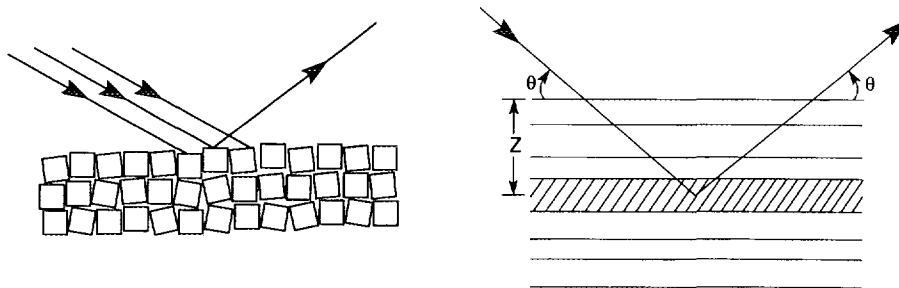

Figure 13. The mosaic multilayer model: it is assumed that the mosaic multilayer is broken up into thin, ordered "crystal" segments, each reflecting coherently and kinematically but with an amplitude that is with a random phase relative to those from the other segments because of a small random variation in the segment's orientation, position, or d spacing. Therefore the total number of photons that are reflected within the diffraction line from this mosaic multilayer is the sum of the angle-integrated number of photons from each thin segment reduced by the transmission factor for x rays to and from the segment, $\exp(-2\mu_1 z/\sin \theta)$ (where z is its depth and μ_1 is the multilayer's linear absorption coefficient). This leads to a corresponding integrated reflectivity for the mosaic multilayer, R_m , which is identical to R_1 in Eq. (73) obtained from the Lorentzian kinematical approximation of the MDP model. Illustrated here are two types of mosaic structure which may lead to this integrated reflectivity, R_m .

number of contributing reflecting planes within the thin crystallites. Another type of mosaic likely for S/E multilayers is that of stacking within the slab of many thin independently scattering, essentially parallel layer systems with random phase relationships because of random spacings between these regions and/or because of a region-to-region variation of the d spacings. It is easy to establish the integrated intensity reflected from an independently coherently reflecting crystallite or thin-layer region using a simple kinematical calculation (allowed because the absorption and multiple-reflection effects are negligible for the small thicknesses involved; see James¹ beginning with his Eq. (2.2)). In the derivation of the integrated reflectivity, R_m , for the mosaic multilayer slab, the intensities (rather than amplitudes) are summed through all angles and from all depths of the slab, taking into account the reduction of the intensity to and from each segment, $\exp(-2\mu_1 z/\sin \theta)$. Here μ_1 is the linear absorption coefficient and $2z/\sin \theta$ is the absorption path into and out from the differential segment at depth z within the mul-

tilayer slab as illustrated in Fig. 13. This integrated reflectivity, R_m , is easily shown to be *identical* to R_1 , that presented above in Eq. (73) as derived using the Lorentzian kinematical approximation of our MDP solution, Eq. (26).

Note that this invariant quality of the *integrated reflectivity*, R (insensitivity to imperfection and instrumental broadening), suggests the importance of designing quantitative measurements that are based upon this diffraction line parameter. When, however, a prediction of the diffraction line broadening by a given Bragg analyzer, ω_m , is required (for example, for unfolding overlapping spectra, or modeling interface structure) the effects of layer interface diffraction and/or specular broadening as noted in Section III.C.2 may need to be included in the multilayer analytical description. (See, for example, Refs. 24, 25, and 26.) Generally, however, an experimental calibration measurement upon known isolated and sharp spectral lines of the analyzer's intrinsic FWHM is also required. (See, for example, Refs. 23 and 6.)

VI. SEMIEMPIRICAL CALCULATION OF THE ATOMIC SCATTERING FACTORS AND SYNTHESIS OF THE PHOTOABSORPTION DATA

Cromer and Liberman²⁷ have shown that the relativistic quantum theory of x-ray dispersion does yield the initial Kramers–Kronig semiclassical dispersion equation but with a small Z -dependent additive relativistic correction. In the Appendix we outline the semiclassical

derivation of a modified Kramers–Kronig description which has been applied in this work in order to identify the simplifying assumptions and approximations that have been made, including the small relativistic correction and the form-factor correction for scattering at the higher

photon energies. A satisfactory agreement of our approximated dispersion relations with some of the *ab initio* theoretical descriptions of x-ray scattering calculated by Kissel and Pratt²⁸ is demonstrated.

These dispersion equations as used for our calculations for $f_1(0)$ and $f_2(0)$ presented in Table I are

$$f_1(0) = Z^* + C \int_0^\infty \frac{\epsilon^2 \mu_a(\epsilon) d\epsilon}{E^2 - \epsilon^2} \quad (76)$$

and

$$f_2(0) = \frac{\pi}{2} CE\mu_a(E), \quad (77)$$

where $\mu_a(E)$ is the atomic photoabsorption cross section at the incident photon energy, E . The constant C is equal to $(\pi r_0 hc)^{-1} = 0.9111 (\text{eV } \text{\AA}^2)^{-1}$, where r_0 is the classical electron radius, h is Planck's constant, and c is the velocity of light. The relation between $f_2(0)$ and the photoabsorption cross section has been derived above from an MDP description of foil transmission in Section III.B1 as well as from the Kramers–Kronig description in the Appendix.

In the limit of very high photon energies, $f_1(0)$ approaches Z^* . In nonrelativistic quantum mechanics, it can be shown from the Thomas–Reiche–Kuhn sum rule that $Z^* = Z$, the atomic number. However, when relativistic effects are taken into account, Z^* is slightly reduced from the atomic number, Z (see recent review by Smith²⁹). The difference, $Z - Z^*$, is approximately equal to E_{tot}/mc^2 , where E_{tot} is the total atomic binding energy.³⁰ This correction, $Z - Z^*$, is significant only for the high- Z elements.

We have fitted the tabulated values of $Z - Z^*$ from Kissel and Pratt²⁸ as a function of Z to obtain

$$Z^* = Z - (Z/82.5)^{2.37}. \quad (78)$$

This expression for Z^* has been used in our evaluations of Eq. (76) to obtain the values of $f_1(0)$ presented in Table I.

The anomalous dispersion integral term in Eq. (76) has a significant value throughout the low-energy x-ray region, becomes very large and negative at the ionization thresholds, and approaches zero for the high-energy x rays. Because of the neglect of “damping” in its derivation (see the Appendix) and because the photoabsorption values near thresholds are strongly affected by the condensed matter state (see Section VII), f_1 cannot be defined by Eq. (76) as an “atomic” scattering factor for photon energies near the absorption edges.

As described above, the atomic scattering factors are based upon a knowledge of the photoabsorption cross sections through an extended energy region. In order to obtain the best-fit values for the photoabsorption cross sections we have made use of the available experimental measurements in the region 10–10,000 eV, and for in-

terpolating in the region 10–1000 eV, we have used the recent theoretical calculations of Doolen and Liberman that are based upon a relativistic, time-dependent, local density approximation which can account for the important collective effects which become large at these low energies.³¹ The experimental photoabsorption data that we have used include those described in works listed in the INSPEC abstract files of the past 10 years and those which have been recently added to the comprehensive NIST database of experimental values by Saloman et al.³² Best-fit determinations of the photoabsorption cross sections, for 10–10,000 eV, were made relying on both theory and measurements and interpolating across Z for the many elements where few measurements were available. For energies higher than 10 keV, there are several excellent syntheses of photoabsorption cross sections.^{32–34} We have chosen that of Biggs and Lighthill³⁴ as it is based on essentially the same experimental database. In their report, Biggs and Lighthill present four-term polynomial fits in the $(1/E)$ variable between absorption edges. Using our photoabsorption best-fit values for the region 10–10,000 eV and those of Biggs and Lighthill³⁴ for the higher photon energies, the dispersion integral in Eq. (76) was numerically evaluated to obtain $f_1(0)$ in the region 50–30,000 eV. For each element, interpolated photoabsorption cross-section values were found at 600 points. In the vicinity of absorption edges, points were added just above and below the edge energy and linear extrapolations in $\log \mu$ vs $\log E$ to the absorption edges were applied as an averaging through possible fine structure. A three-term polynomial was calculated to fit successive sets of our lower energy interpolated points, which then permitted a direct integration of the dispersion integral for that energy interval. At higher energies, the polynomial fit of Biggs and Lighthill,³⁴ between 10 keV and the next absorption edge, was normalized to match our value at 10 keV and then directly integrated. The upper limit, of 500 keV, was chosen to be significantly above the highest K -absorption edge of the elements considered (that is, U, 115.6 keV). The contribution to the integral for energies higher than this can be readily shown to be insignificant.

As the atomic coherent scattering factors, f , that are described above approach simply the form-factor value, f_0 , at the higher photon energies, the atomic incoherent scattering increases. As noted in Section II.E and discussed further in the Appendix the amount of incoherent scattering can be estimated from relations based upon these atomic coherent scattering factors for the higher energies. In Section III.B.2 the required incoherent scattering correction of the measured attenuation cross sections in the determination of the photoabsorption cross sections from foil transmission measurements on the light elements at the higher photon energies has been described and has been applied in our synthesis of the photoabsorption database.

VII. EXPERIMENTAL VERIFICATION OF "ATOMIC-LIKE" SCATTERING WITHIN CONDENSED MATTER: THRESHOLD LIMITS

The methods that have been outlined above for applying the atomic scattering factors to the description of the basic x-ray interactions of particular interest in applied x-ray physics follow from the assumption that in condensed matter interactions the x-ray scattering by individual atoms is essentially unaffected by the condensed state of the system. As described in Section VI, for the x-ray region of interest here, only then can both $f_1(0)$ and $f_2(0)$ be determined from the atomic photoabsorption cross sections. It is therefore important to consider to what extent and to within what limits the measured photoabsorption in condensed matter is indeed atomic-like, that is, with cross sections that are independent of the condensed state of the system. Generally it has been found experimentally that photoabsorption within condensed matter is indeed atomic-like above about 50 eV except in the energy regions near absorption thresholds. (See, for example, the excellent monograph by Berkowitz, *Photoabsorption, Photoionization and Photoelectron Spectroscopy*³⁵).

Note that an exception and an example of non-atomic-like x-ray scattering are given by chemically bound hydrogen. For example, throughout the low-energy x-ray region, the photoabsorption cross section of molecular hydrogen is about 2.6 rather than 2 times the atomic cross section.³⁶⁻³⁸ We have chosen for our tabulated values those of atomic hydrogen based on its theoretical values,^{31,36} which are exact for this one electron system (and as was tabulated in our 1982 compilation).

At energies near the absorption edges the photoabsorption cross section is found to depend on the chemical environment of the atom since transitions are to weakly bound excited states or to unbound shape resonances giving rise to near-edge x-ray absorption fine structure (NEXAFS).¹¹ At energies somewhat higher than this there are weaker oscillations in the cross section as a function of energy resulting from the back-scattering of the outgoing wave function of the photoelectron (EXAFS) from neighboring atoms. As is noted in the following examples of experimentally measured photoabsorption cross sections (including those presented graphically in Table I at all energies), the effects of the condensed state are significant only at the lower energies of interest here.

As examples of the applicability and accuracy of the atomic scattering factors that are tabulated in Table I, experimental total reflection and Bragg reflection data are compared with those predicted by using the MDP model relations given in Sections III and IV along with the modified Kramers-Kronig atomic scattering factors tabulated here.

In Fig. 14 the photoabsorption cross sections are plotted for xenon in both the gaseous (atomic) and the

solid states.³⁹ As can be seen, at least for the region shown (65–150 eV), the measured cross sections are very similar for both states.

The atomic-like behavior of a molecular absorption coefficient is illustrated with the measurements of CO₂ from Ref. 40, which are presented in Fig. 15. Superimposed upon these data is an atomic-like absorption spectrum for CO₂ generated by summing the atomic photoabsorption cross sections for neutral atoms of carbon and oxygen taken from our Table I. Note that the measured absorption cross section exhibits structure above both the carbon *K* and the oxygen *K* edges which is not included in the atomic absorption cross sections from Table I.

Recently the absolute photoabsorption cross sections have been obtained from transmission measurements on a selected series of foil systems, beryllium through uranium, using Stanford's synchrotron radiation source at SSRL.⁴¹ Presented here in Fig. 16 and Fig. 17 are examples of the data obtained for amorphous carbon foil near its *K* edge and for nickel foil near its *L* edge. The results of including the measured near-edge structure in the evaluation of the atomic scattering factors is illustrated in Fig. 16 for amorphous carbon. Superimposed are the values for these elements as compiled in Table I.

Photoabsorption measurements provide a direct measure of the f_2 component of the atomic scattering factor. Reflectivity measurements vs angle or photon energy may be applied to determine the f_1 component by fitting these measurements to the Fresnel curves. An example of a reflectivity measurement is presented in Fig. 18 for

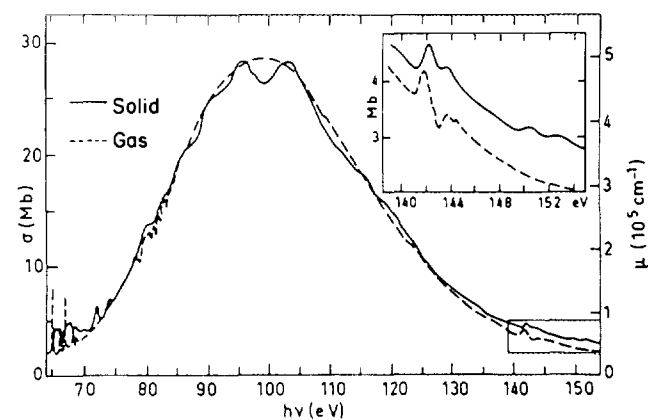

Figure 14. The comparison of measured photoabsorption cross sections from Haensel et al.³⁹ for xenon in the gaseous (atomic) and in the solid (condensed matter) state in the low-energy x-ray region.

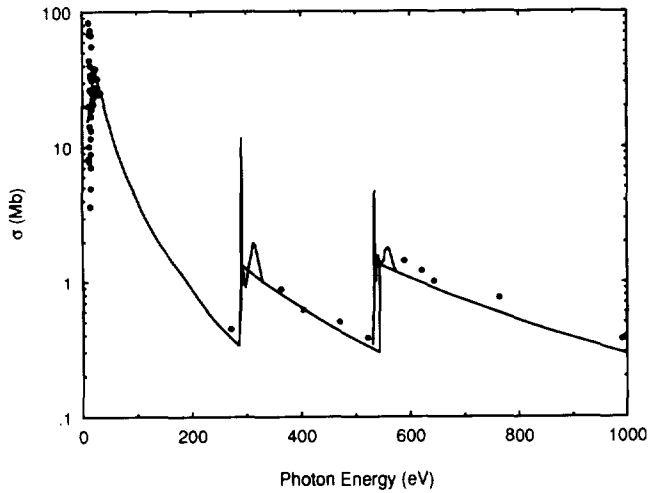

Figure 15. Experimental photoabsorption data for the CO₂ molecule taken from Ref. 40 compared with a plot calculated for the simple sum of atomic photoabsorption cross sections taken from Table I.

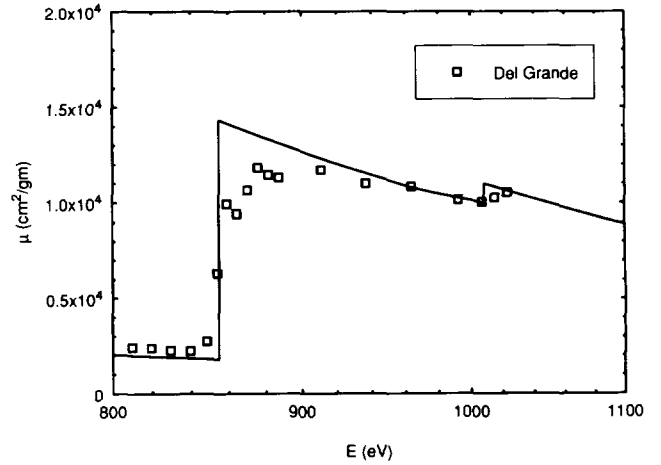

Figure 17. Comparing the measured photoabsorption cross sections for nickel foil ($Z = 28$) around the L -threshold region from Del Grande⁴¹ with those tabulated here in Table I.

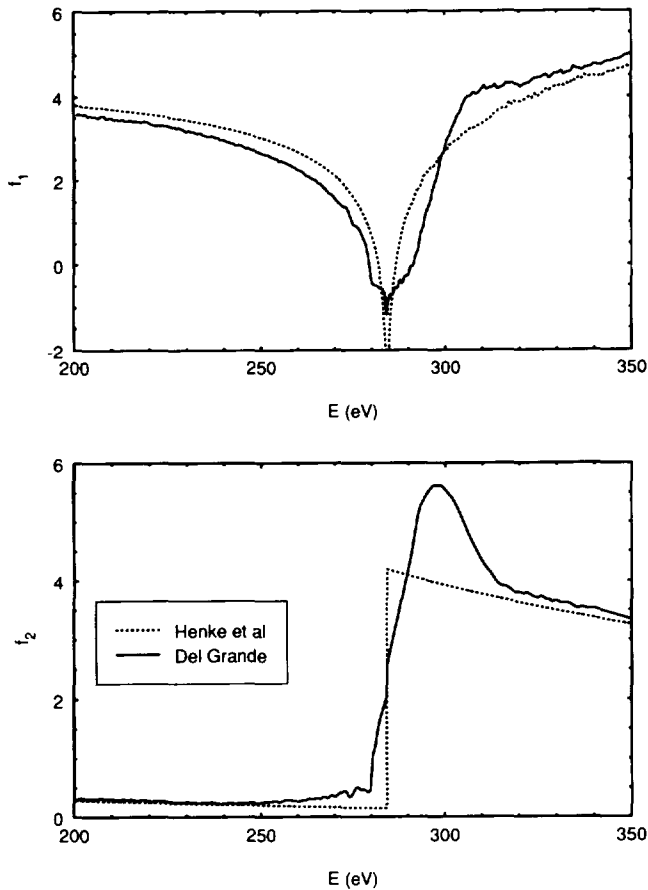

Figure 16. Comparing the measured f_1 and f_2 values for a carbon foil ($Z = 6$) around the K -threshold region (Del Grande⁴¹) with those tabulated here in Table I.

a Si(111) wafer at 1487 eV ($Al K_{\alpha}$);⁴² the Fresnel reflection curve based upon our tabulated f_1 and f_2 values is also shown. In Fig. 19 are presented the determinations of f_1 values from reflectivity measurements on mirrors of C, Si, Mo, and W. The measurements are those of Windt⁴³ obtained using line sources in the energy region of 40–

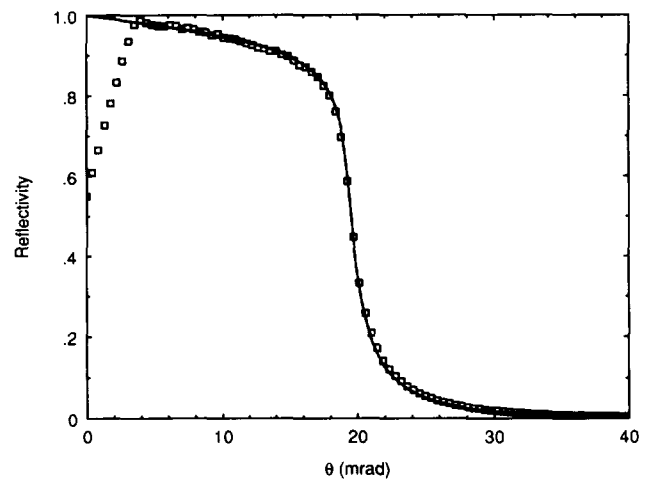

Figure 18. Comparing a measured reflection curve around the total reflection cutoff region from a silicon(111) wafer with (8.34-Å/1487-eV) x radiation⁴² with that predicted by the Fresnel equations with the atomic scattering factors tabulated in Table I. (The low-angle cutoff is instrumental.)

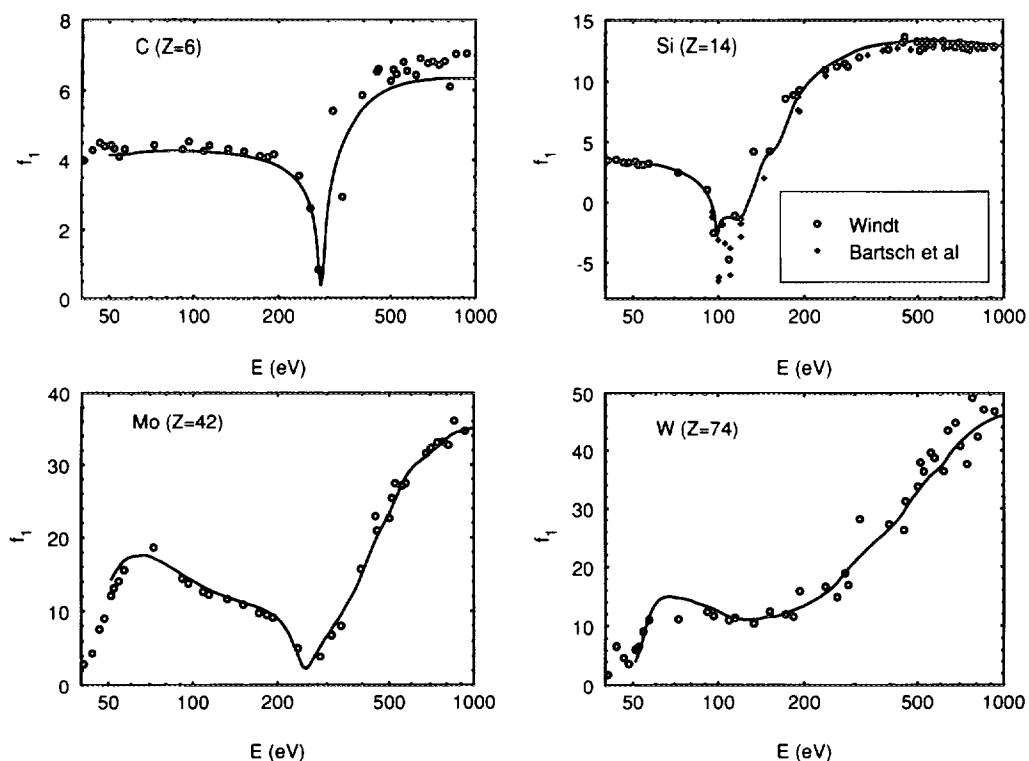

Figure 19. Comparing the f_1 values obtained by fitting measured small-angle total reflection data in the region 50–1000 eV with the f_1 values derived from the modified Kramers–Kronig relations and tabulated in Table I. The measurements are from Windt⁴³ for mirrors of C, Si, Mo, and W and from Bartsch et al.⁴⁴ for Si (assuming bulk density).

1000 eV and Bartsch et al.⁴⁴ for silicon obtained at HAS-YLAB. The continuous curves in these plots have been derived from our modified Kramers–Kronig calculations of f_1 as tabulated in Table I.

Finally we compare in Fig. 20 calculated integrated reflectivities for Bragg reflections based upon the modified Darwin–Prins model discussed above and upon the f_1 and f_2 values tabulated in Table I with the integrated reflectivities measured by Barrus et al.⁴⁵ on the acid phthalate crystal analyzers in the region 400–3000 eV.

Computer Files

Computer files with finely spaced tables of the mass absorption cross section μ and of the atomic scattering factors $f_1(0)$ and $f_2(0)$ for $Z = 1$ –92 and $E = 50$ –30,000 eV are available from the authors. Requests should be directed to E. M. Gullikson, Center for X-Ray Optics M/S 2-400, Lawrence Berkeley Laboratory, 1 Cyclotron Rd, Berkeley, CA 94720.

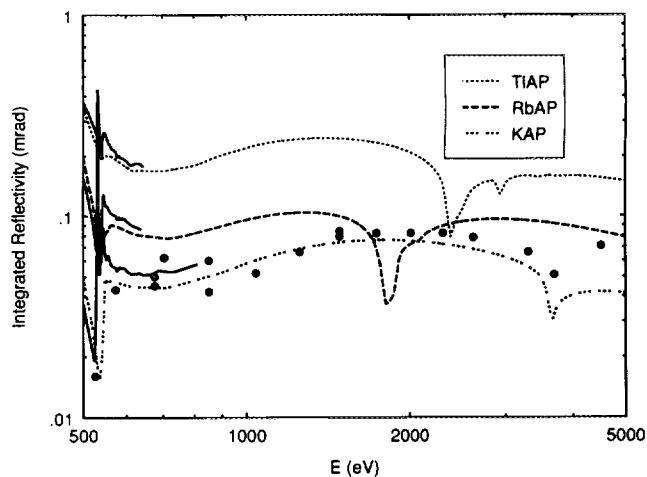

Figure 20. Comparison of the integrated reflectivity (R) curves for the acid phthalate analyzers of potassium, rubidium, and thallium that have been experimentally measured by Barrus et al.⁴⁵ (solid lines) with those calculated using the MDP model and with the tabulated atomic scattering factors that have been presented in this work. The dots are experimental data for KAP; see Table IV for details.

APPENDIX: DISPERSION RELATIONS FOR THE SEMIEMPIRICAL DETERMINATION OF ATOMIC SCATTERING FACTORS, COMPARISON WITH RESULTS OF *AB INITIO* THEORY, AND ESTIMATION OF INCOHERENT SCATTERING CROSS SECTIONS

In Section III.B.2 we related the $f_2(0)$ component of the atomic scattering factor to the photoabsorption cross sections as determined by normal incidence, nondiffracting uniform foil transmission measurements. The assumption needed to establish this empirical relationship, viz. that the x-ray scattering within condensed matter is atomic-like and may be accurately defined by atomic scattering factors except near threshold energies, has been justified by comparisons of atomic description and experiment as those presented in Section VII. For the light elements at the higher energies a correction for *incoherent* scattering for the foil transmission measurements is required as defined in Section III.B.2; the incoherent scattering cross section is presented in terms of the atomic scattering factors at the conclusion of this appendix.

In Section VI we described the determination of the $f_1(0)$ component of the atomic scattering factors as based primarily upon the measured photoabsorption data by the numerical evaluation of a modified Kramers–Kronig dispersion relation for $f_1(0)$ given by Eq. (76). We now present an outline of the development of this equation along with a comparison of its semiempirically predicted f -values with those of the *ab initio* S -matrix theory.

Classically the forced-oscillator solution for the scattering of an electromagnetic wave of frequency ω_0 by a single electron bound to a nucleus and with a resonant frequency of ω yields an atomic scattering factor (e.g., see Ref. 1, p. 137)

$$f = \frac{\omega_0^2}{(\omega_0^2 - \omega^2) - i\eta\omega_0}, \quad (\text{A1})$$

in which η is a radiation damping constant.

Semiclassically, a bound atomic electron (type q of an n, l subshell) is not assigned a single equilibrium position but rather is considered to be statistically distributed in position about the nucleus with a probability density $|\psi|^2$. It is assigned a corresponding continuum of characteristic frequencies, ω , with an associated differential oscillator strength $(dg/d\omega)d\omega$, and under the interaction of an electromagnetic wave of frequency ω_0 , the scattering factor for the q -type electron is then given by the integral

$$f_q = \int_{\omega_q}^{\infty} \frac{\omega_0^2 (dg_q/d\omega) d\omega}{(\omega_0^2 - \omega^2) - i\eta_q\omega_0}, \quad (\text{A2})$$

in which ω_q is its threshold frequency. The threshold energy E_q is equal to $\hbar\omega_q$. It is convenient to express Eq. (A2) in terms of the energy variables with the incident photon energy E equal to $\hbar\omega_0$ and the damping constant

η'_q equal to $\hbar\eta_q$, obtaining

$$f_q = \int_{E_q}^{\infty} \frac{E^2 (dg_q/d\epsilon) d\epsilon}{(E^2 - \epsilon^2) - i\eta'_q E}. \quad (\text{A3})$$

It is interesting to note that the formal modern methods of relativistic quantum dispersion theory (see, for example, Cromer and Liberman,²⁷ Jansen,⁴⁶ and the reviews of Fano and Cooper⁴⁷ and Smith²⁹) yield the same result as Eq. (A3) except for a small added relativistic correction term which is included in our final modified Kramers–Kronig dispersion relations presented below and applied in this work.

We now rewrite Eq. (A3) as the sum of two integrals:

$$f_q = \int_{E_q}^{\infty} \frac{(E^2 - \epsilon^2)(dg_q/d\epsilon) d\epsilon}{(E^2 - \epsilon^2) - i\eta'_q E} + \int_{E_q}^{\infty} \frac{\epsilon^2 (dg_q/d\epsilon) d\epsilon}{(E^2 - \epsilon^2) - i\eta'_q E}. \quad (\text{A4})$$

Because η'_q/E is very small compared with unity (see, for example, Parratt and Hempstead⁴⁸) the first integral becomes simply equal to g_q , the total oscillator strength of this electron in the n, l subshell. g_q is the high-energy limit value of the f_q scattering factor. The remaining energy-dependent second term in Eq. (A4) expresses the anomalous dispersion component of f_q resulting from the effect of the electron's binding to the nucleus.

The quantum mechanics formally yields a simple relationship between the oscillator density, $dg_q/d\omega$, and the transition probability, $\mu_q(E)$, for promoting this q electron to the ionization continuum, and for photon energies just above the photoabsorption threshold energy, E_q , for promoting this electron into the higher bound states of the atom—often with a subsequent ejection of an Auger electron (called indirect photoionization). This relation is

$$dg_q/d\epsilon = C\mu_q(\epsilon), \quad (\text{A5})$$

where $C = (\pi r_0 \hbar c)^{-1} = 0.9111 (\text{eV } \text{\AA}^2)^{-1}$, in which r_0 , \hbar , and c are the classical electron radius, Planck's constant, and the velocity of light.

Note that because the oscillator density and hence also the transition probability, μ_q , have discrete values for the bound-state transitions we might have appended here a summation term to the dispersion integrals to account for the bound-state contributions in the energy interval just above the photoabsorption threshold, E_q . Rather we employ here a convenient alternative approach of defining the oscillator density and the corresponding partial photoabsorption cross section, μ_q , as continuous functions

through this initial energy region with average values that reflect the sum of the bound-state transition oscillator strengths—and therefore requiring only integral representations with integration range of E_q to infinity.

We now express f_q using Eqs. (A4) and (A5) and separating the real and imaginary components, $f_{1q} + if_{2q}$, and obtain

$$f_{1q} = g_q + C \int_{E_q}^{\infty} \frac{\epsilon^2 (E^2 - \epsilon^2) \mu_q(\epsilon) d\epsilon}{(E^2 - \epsilon^2)^2 + (\eta'_q E)^2},$$

and

$$f_{2q} = C \int_{E_q}^{\infty} \frac{\epsilon^2 \eta'_q E \mu_q(\epsilon) d\epsilon}{(E^2 - \epsilon^2)^2 + (\eta'_q E)^2}. \quad (\text{A6})$$

Again, because η'_q/E is very small compared with unity, it is easily shown that the integral in the expression for f_{1q} in Eq. (A6) is essentially independent of the damping term except for photon energies near threshold, E_q . (See, for example, Parratt and Hempstead.⁴⁸) Therefore for the calculation of f_{1q} at photon energies outside the threshold region we may apply the simplified dispersion relation

$$f_{1q} = g_q + C \int_{E_q}^{\infty} \frac{\epsilon^2 \mu_q(\epsilon) d\epsilon}{E^2 - \epsilon^2}. \quad (\text{A7})$$

Similarly, f_{2q} is essentially independent of η'_q . The integral for f_{2q} in Eq. (A6) is significant only when the integration variable ϵ approaches E . Therefore, we may replace the quantity $(E^2 - \epsilon^2)$ by $2E(E - \epsilon)$ and to within a very good approximation, we express f_{2q} in Eq. (A6) as

$$f_{2q} \approx \frac{C}{4} \eta'_q E \mu_q(E) \int_{E_q}^{\infty} \frac{d\epsilon}{(E - \epsilon)^2 + (\eta'_q/2)^2}, \quad (\text{A8})$$

which then directly integrates to

$$f_{2q} = \frac{C}{2} E \mu_q(E) \left[\frac{\pi}{2} + \tan^{-1} \left(\frac{2(E - E_q)}{\eta'_q} \right) \right]. \quad (\text{A9})$$

Now for the incident energy E larger than E_q (and since $\eta'_q/E \ll 1$), f_{2q} becomes

$$\begin{aligned} f_{2q} &= (\pi/2) C E \mu_q(E) & \text{if } E > E_q, \\ f_{2q} &= 0 & \text{if } E < E_q. \end{aligned} \quad (\text{A10})$$

It remains now to sum the scattering-factor contributions from the total number of electrons, z_q , of an n, l subshell and then from all of the subshells to obtain the angle-independent atomic scattering factor, $f_1(0) + if_2(0)$. As described earlier, this basic atomic scattering factor, which we tabulate in this work, applies directly for the case of forward scattering and/or for wavelengths which are large compared with atomic dimensions for which we may consider that all of the electrons within the atom are scattering in phase and an arithmetic sum of the components f_{1q} and f_{2q} can be taken to yield the angle-independent $f_1(0)$ and $f_2(0)$ components.

Using Eq. (A7) we obtain for $f_1(0)$

$$f_1(0) = \sum_q z_q g_q + C \sum_q \int_{E_q}^{\infty} \frac{\epsilon^2 z_q \mu_q(\epsilon) d\epsilon}{E^2 - \epsilon^2}. \quad (\text{A11})$$

The relativistic quantum dispersion theory (see, for example, Smith²⁹) yields for $\sum_q z_q g_q$ the atomic number, Z , minus a small relativistic correction equal to E_{tot}/mc^2 (the total binding energy of the atomic electrons/electron rest mass energy); that is,

$$\sum_q z_q g_q = Z^* = Z - E_{\text{tot}}/mc^2. \quad (\text{A12})$$

Because the relative effect of this Z -dependent relativistic correction term may usually be neglected except possibly for the heaviest elements and near thresholds, we include it in our tabulations of $f_1(0)$ using a simple fit to recently tabulated values²⁸:

$$E_{\text{tot}}/mc^2 \approx (Z/82.5)^{2.37}. \quad (\text{A13})$$

(Note that the expression in Eq. (A12) without the relativistic correction term is the familiar semiclassical Thomas–Reiche–Kuhn sum-rule result.)

Because the partial photoabsorption cross section, μ_q , has zero value for photon energies below E_q , we may take the summation inside the integral in Eq. (A11), make the integration range from zero to infinity, and let the $\sum_q z_q \mu_q$ be replaced by the total atomic cross section, μ_a , obtaining

$$f_1(0) = Z^* + C \int_0^{\infty} \frac{\epsilon^2 \mu_a(\epsilon) d\epsilon}{E^2 - \epsilon^2}, \quad (\text{A14})$$

which is the result given in Eq. (76) of Section VI as our basis for the semiempirical calculation of the $f_1(0)$ tables. As noted above, we have used an analytical continuation of the μ_a curves to the thresholds which average through the near absorption edge structures and with a sufficiently accurate inclusion of the effect of the bound-state oscillator strengths upon $f_1(0)$ for photon energies not close to the thresholds.

We now obtain an expression for the $f_2(0)$ component for the case of forward scattering and/or for wavelengths that are large compared with atomic dimensions by a simple summation of the f_{2q} given in Eq. (A10), yielding

$$f_2(0) = \sum_q z_q f_{2q} = \frac{\pi}{2} C E \mu_a. \quad (\text{A15})$$

It is interesting to note that this dispersion theory result is identical to that presented above in Section III.B.1. for the semiempirical determination of $f_2(0)$ based upon a normal incidence, nondiffracting foil transmission description using the modified Darwin–Prins non-Bragg interaction model.

Next we outline the assumptions made in deriving a relatively simple procedure for determining an atomic

scattering factor for the higher energy photons and/or for the larger angles of scattering. As discussed earlier, for the shorter wavelengths and nonzero scattering angles the amplitudes scattered by the atomic electrons are not in phase and their addition must take into account their spatial distribution about the nucleus. As James has pointed out (Ref. 1, pp. 145–146) a very good approximation for the atomic scattering factor for the higher photon energies and/or large scattering angles may be obtained by simply replacing Z^* in Eq. (A14) by the well-tabulated⁸ form factor, f_0 , for the element of atomic number, Z . f_0 approaches its maximum value of Z as its argument, $(\sin \theta)/\lambda$, approaches zero and accounts for the angle-dependent diffraction by the atom's charge distribution (usually assumed to be spherically symmetric).

The assumption made in this approximation is that in summing f_{1q} and f_{2q} , taking into account possible phase differences associated with nonzero scattering angles, only the high-energy limit, $\sum_q g_q$, needs to be a vector sum and the integral terms may be simply summed algebraically as has been already done above in deriving $f_1(0)$ and $f_2(0)$. This is because, as noted earlier, the integral terms in f_{1q} and f_{2q} have appreciable values only for photon energies near threshold for which the corresponding wavelengths are large compared with the dimensions of the active q -electron orbitals and the relative phase differences are negligible. The vector sum over a spherical charge distribution may then be written for $\sum_q z_q g_q$ (see, for example, Ref. 1, p. 97),

$$\sum_q z_q g_q = f_0 = \int_0^\infty U(r) \frac{\sin Qr}{Qr} dr, \quad (\text{A16})$$

in which $U(r)$ is the radial charge distribution for the atom and the variable Q is equal to $4\pi(\sin \theta)/\lambda$. The value of f_0 is essentially equal to Z for $(\sin \theta)/\lambda < 0.05 \text{ \AA}^{-1}$ and for most elements it drops to about $0.9Z$ for $(\sin \theta)/\lambda \approx 0.1 \text{ \AA}^{-1}$ (for example, for back-scattered 10-\AA radiation).

By defining $Z - f_0$ as Δf_0 , we may accurately calculate the atomic scattering factor for the higher photon energies and for any scattering angles, using the angle-independent atomic scattering factors $f_1(0)$ and $f_2(0)$ that are tabulated here, simply by the relation

$$f = f_1 + if_2 = f_1(0) - \Delta f_0(\theta) + if_2(0). \quad (\text{A17})$$

As a test of the validity of the assumptions and approximations that have been made in establishing the modified Kramers–Kronig dispersion relations that we have used for the tabulations and applications that are presented in the appended tables and graphs, we compare plots of f_1 vs E for the scattering angles $2\theta = 0^\circ$, 60° , and 180° for several elements as calculated by Eq. (A17) and by the *ab initio* second-order, relativistic S -matrix theory of Kissel and Pratt.²⁸ These are presented in Fig. A1. Here

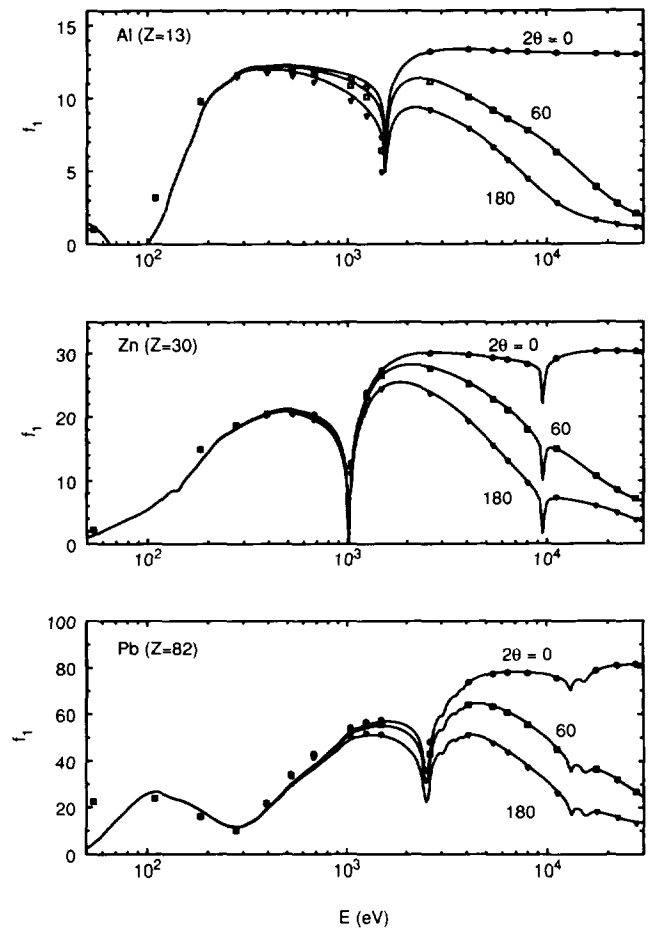

Figure A1. Comparing the S -matrix theoretical f_1 values of Kissel and Pratt²⁸ for the elements aluminum, zinc, and lead for scattering angles of 0° , 60° , and 180° with those (solid lines) based upon $f_1(0)$ values tabulated here in Table I and a simple angle-dependent form-factor correction as given in Eq. (A17).

we have used for Δf_0 the analytical expression given in the *International Tables for X-Ray Crystallography*.⁸

Finally, we estimate the magnitude of the incoherent scattering, viz. Compton scattering, which may become significant in x-ray measurements at the higher of the photon energies of interest here. As has been reviewed in some detail by James¹ the total intensity, coherent plus incoherent, that is scattered by an isolated atom may be expressed in terms of the electronic scattering factors, f_q , with sufficient accuracy for most applied x-ray physics (see, for example, James' recapitulation of incoherent scattering formulas in Ref. 1, p. 461). By neglecting the small exchange interactions among the atomic electrons, the scattered intensity formulas from the quantum me-

chanics (for example, Hartree–Waller equation) reduce to essentially those derived semiclassically (for example, Compton-Raman equation), viz.

$$I_{\text{tot}} = I_{\text{T}} \left(\sum_q f_q^2 + \sum_q (1 - f_q^2) \right), \quad (\text{A18})$$

where I_{T} is the intensity scattered by the classical Thomsonian electron if it alone were at the position of the atom. As defined in Section I the $\sum_q f_q$ is equal to the atomic scattering factor. We recognize the first term, $I_{\text{T}} f^2$, to be the intensity scattered coherently by a single atom. (Generally $f^2 = f_1^2 + f_2^2$. As described in our modified Darwin–Prins analysis, if the atom is not isolated, the amplitudes scattered by each of the collection of atoms must be summed, yielding a total amplitude in a given direction which, when multiplied by its complex conjugate, gives the scattered intensity. This differential coherently scattered intensity is diffracted into an angular distribution as determined by the structure of the condensed matter as discussed in Sections III and IV.) The second term $\sum_q (1 - f_q^2)$, is identified as the remaining incoherently Compton scattered component. (For incoherent scattering by condensed matter, such atomic incoherently scattered intensity components must be summed directly after each is multiplied by an appropriate transmission factor as depicted in Fig. 7 for the total single Compton scattered intensity at a given angle, 2θ .) The electronic scattering factors, f_q , in this second term can be determined by detailed theoretical quantum–mechanical calculations to obtain this differential atomic scattering component.⁴⁹ It is instructive here to compare these results to those obtained by letting f_q be approximated by an average value for the higher energies, f_0/Z , where Z is the atomic number. Using the differential scattering cross sections to which I and I_{T} are proportional, we obtain

$$(d\sigma/d\Omega)_{\text{inc}} \approx (d\sigma/d\Omega)_{\text{T}} (Z - f_0^2/Z), \quad (\text{A19})$$

which is the relatively simple and approximate relation that is applied in Eqs. (32) and (33) for estimating the effect of incoherent scattering in Section II.E. In Table II we present calculated values for μ_{inc} in cm^2/g for the light elements, $Z = 2$ to 18, and for the photon energies that are large compared to the electronic binding energies. The numerical integrations of Eq. (36) were obtained by using the analytical expression for f_0 given in Ref. 8. The values in Table II overestimate μ_{inc} by 10–40% from the corresponding more precise and detailed calculations presented in Ref. 49. We have also plotted values of $\mu_{\text{a}} + \mu_{\text{inc}}$ in the plots in Table I (dashed curve) in order to demonstrate for what photon energies and light elements incoherent scattering contributes significantly to x-ray attenuation below 30 keV.

For most of the low-energy x-ray region of interest here the incoherent scattering cross section is small compared to that of photoabsorption. For this reason, only

single Compton scattering events were considered, for example, in Section II.E, for a prediction of the incoherently scattered background radiation that may become significant in the non-Bragg angular regions. For the extreme cases at the higher photon energies of interest here and with the lightest elements, multiple Compton scattering effects may need to be considered. See, for example, Ref. 50.

Acknowledgments

The authors gratefully acknowledge the invaluable assistance in the initial preparations of this work of H. T. Yamada, J. Uejio, A. Oren, J. Kerner, and M. Fryer. We also thank our many colleagues for their helpful contributions, particularly D. T. Attwood, F. Biggs, N. K. Del Grande, G. Doolen, J. H. Hubbell, L. Kissel, J. Kortright, D. Liberman, R. C. C. Perera, J. H. Underwood, D. Windt, and the P-14 X-Ray Diagnostics Group of the Los Alamos National Laboratory. This project has been supported by the Director, Office of Energy Research, Materials Sciences Division, of the U.S. Department of Energy under Contract AC03-76SF00098.

References

1. R. W. James, *The Optical Principles of the Diffraction of X-Rays* (Ox Bow Press, Woodbridge, CT, 1982)
2. Notation: In other x-ray literature (cf. James¹ and Klug and Alexander²¹) the atomic scattering factor, f , is written as $f = f_0 + \Delta f' + i\Delta f''$, in which f_0 , the atomic form factor, is a function of Z and $(\sin \theta)/\lambda$ and is the high-energy limit term; $\Delta f'$ and $\Delta f''$ are the energy-dependent anomalous dispersion terms which may also depend upon the angle of scattering. In this work we have written for the atomic scattering factor to within a good approximation $f = f_1 + if_2 = f_1(0) - \Delta f_0 + if_2(0)$, where $f_1(0)$ and $f_2(0)$ are tabulated in Table I and are angle-independent forward-scattering components. We note, therefore the following approximate correspondence: $\Delta f' = f_1(0) - Z$ and $\Delta f'' = f_2(0)$.
3. B. L. Henke, P. Lee, T. J. Tanaka, R. L. Shimabukuro, and B. K. Fujikawa, *ATOMIC DATA AND NUCLEAR DATA TABLES* 27, 1 (1982)
4. F. A. Jenkins and H. E. White, *Fundamentals of Optics* (McGraw–Hill, New York, 1976), 4th ed.
5. A. H. Compton and S. K. Allison, *X-Rays in Theory and Experiment* (Van Nostrand, New York, 1935), 2nd ed.

6. B. L. Henke, E. M. Gullikson, J. Kerner, A. L. Oren, and R. L. Blake, *J. X-Ray Sci. Technol.* **2**, 17 (1990)
7. J. H. Hubbell and I. Øverbø, *J. Phys. Chem. Ref. Data* **8**, 69 (1979); R. Schaupp, M. Schumacher, F. Smend, P. Rullhausen, and J. H. Hubbell, *J. Phys. Chem. Ref. Data* **12**, 467 (1983)
8. Kynoch Press, *International Tables for X-Ray Crystallography* (Birmingham, England 1974), Vol. IV
9. B. L. Henke and J. W. M. DuMond, *J. Appl. Phys.* **26**, 903-917 (1955)
10. B. L. Henke, J. P. Knauer, and K. Premaratne, *J. Appl. Phys.* **52**, 1509 (1981)
11. J. Stöhr, *NEXAFS Spectroscopy* (Springer-Verlag, Heidelberg, 1992), Springer Series in Surface Sciences, Vol. 25
12. B. L. Henke, *Phys. Rev. A* **6**, 94 (1972)
13. L. A. Smirnov, *Opt. Spectrosc. (USSR)* **43**, 333 (1977); L. A. Smirnov, T. D. Sotnikova, B. S. Anokhin, and B. Z. Taibin, *Opt. Spectrosc. (USSR)* **46**, 329 (1979)
14. S. K. Sinha, E. B. Sirota, S. Garoff, and H. B. Stanley, *Phys. Rev. B* **38**, 4 (1988)
15. P. Beckman, *The Scattering of Electromagnetic Waves by Rough Surfaces* (Pergamon Press, New York, 1963)
16. J. C. Davis, A. L. Oren, J. Uejio, H. T. Yamada, E. M. Gullikson and B. L. Henke, *Small Computer Programs for the MDP and OEM Characterization of Multilayers* (Lawrence Berkeley Laboratory, Berkeley, CA), in press
17. J. H. Underwood and T. W. Barbee, Jr., *Appl. Opt.* **20**, 3027 (1981)
18. H. T. Yamada and T. Tanaka, in press
19. R. W. G. Wyckoff, *Crystal Structures* (Interscience Publishers, New York, 1963), 2nd ed.
20. E. P. Bertin, *Principles and Practice of X-Ray Spectrometric Analysis* (Plenum, New York, 1975), 2nd ed., p. 981
21. H. P. Klug and L. E. Alexander, *X-Ray Diffraction Procedures* (Wiley, New York, 1973)
22. We correct here a sign error made in Ref. [6], Eqs. (32) and (33) for the structure factors for the symmetrical and asymmetrical linear transition interfaces that appeared in [6]
23. B. L. Henke, R. C. C. Perera, E. M. Gullikson, and M. L. Schattenburg, *J. Appl. Phys.* **49**, 480 (1978)
24. B. Lengeler, *Advances in X-Ray Analysis* (Plenum, New York, 1992), Vol. 35
25. J. H. Underwood and T. W. Barbee, in *AIP Conference Proceedings. No. 75. Low Energy X-Ray Diagnostics, 1981, Monterey, CA*, edited by D. T. Attwood and B. L. Henke (Amer. Inst. Phys., New York, 1982), p. 170
26. E. Spiller and A. E. Rosenbluth, *Opt. Eng.* **25**, 954 (1986)
27. D. T. Cromer and D. Liberman, *J. Chem. Phys.* **53**, 1891 (1970)
28. L. Kissel and R. H. Pratt, *Acta Crystallogr. Sec. A* **46**, 170 (1990); L. Kissel, private communication
29. D. Y. Smith, *Phys. Rev. A* **35**, 3381 (1987)
30. The relativistic correction originally estimated in Ref. [27] to be $(5/3) E_{\text{tot}}/mc^2$ using a dipole approximation has since been shown²⁸ to be too large by a factor of 5/3
31. G. Doolen and D. A. Liberman, *Phys. Scripta* **36**, 77 (1987)
32. E. B. Saloman, J. H. Hubbell, and J. H. Scofield, *ATOMIC DATA AND NUCLEAR DATA TABLES* **38**, 1 (1988)
33. D. E. Cullen, M. H. Chen, J. H. Hubbell, S. T. Perkins, E. F. Plechaty, J. A. Rathkopf, and J. H. Scofield, *UCRL-50400* (1989), Vol. 6
34. F. Biggs and R. Lighthill, *Sandia Report SAND87-0070 UC-34* (1988)
35. J. Berkowitz, *Photoabsorption, Photoionization and Photoelectron Spectroscopy* (Academic Press, New York, 1979)
36. J. A. R. Samson, *Advances in Atomic and Nuclear Physics* (Academic Press, New York, 1966), p. 177
37. E. L. Kosarev and E. R. Podolyak, *Nucl. Instrum. Methods Phys. Res. A* **261**, 161 (1987)
38. J. W. Gallagher, C. E. Brion, J. A. R. Samson, and P. W. Langhoff, *J. Phys. Chem. Ref. Data* **17**, 9 (1988)
39. R. Haensel, G. Keitel, E. E. Koch, M. Skibowski, and P. Schreiber, *Opt. Commun.* **2**, 59 (1970)
40. V. N. Sivkov, V. N. Akimov, and A. S. Vinogradov, *Opt. Spectrosc. (USSR)* **63**, 162 (1987)
41. N. K. Del Grande, *Phys. Scripta* **41**, 110 (1990); private communication
42. E. M. Gullikson, in press
43. D. Windt, *Appl. Opt.* **30**, 15 (1991)

44. F. R. Bartsch, H. G. Birken, C. Kunz, and R. Wolf, *Semicond. Sci. Technol.* **5**, 974 (1990)
45. D. M. Barrus, R. L. Blake, H. Felthausen, E. E. Fenimore and A. J. Burek in *AIP Conference Proceedings No. 75, Low Energy X-Ray Diagnostics, 1981, Monterey, CA* edited by D. T. Attwood and B. L. Henke, (Amer. Inst. Phys., New York, 1981), p. 115
46. M. S. Jensen, *Phys. Lett. A* **74**, 41 (1979)
47. U. Fano and J. W. Cooper, *Rev. Mod. Phys.* **40**, 441 (1968)
48. L. G. Parratt and C. F. Hempstead, *Phys. Rev.* **94**, 1593 (1954)
49. J. H. Hubbell, Wm. J. Veigele, E. A. Briggs, R. T. Brown, D. T. Cromer, and R. J. Howerton, *J. Phys. Chem. Ref. Data* **4**, 471 (1975)
50. J. H. Hubbell, *Polarization Effects in Coherent and Incoherent Scattering: Survey of Measurements and Theory Relevant to Radiation Transport Calculations*, NISTIR 4881 (July 1992)

EXPLANATION OF TABLES

TABLE I. Photoabsorption Cross Sections and Atomic Scattering Factors, $Z = 1-92$, $E = 50-30,000$ eV

Line	Line designations for characteristic x-rays. (For origin of lines see, for example, Ref. 5, p. 630.) $K\alpha$ and $L\alpha$ in the table refer to $K\alpha_1$ and $L\alpha_1$. He I refers to the $1s^2-1s2p$ transition in neutral helium
E	Photon energy for the listed line in electron volts (eV); values from J. A. Bearden, Rev. Mod. Phys. 39 , 78 (1967)
λ	Wavelength in angstroms (Å)
μ	Photoabsorption cross section in cm^2/g . Experimental points are from references listed at the bottom of each page. The total cross section, $\mu_t = \mu + \mu_{\text{inc}}$, has also been plotted as a dashed curve for elements $Z = 1-18$
μ_a	Photoabsorption cross section in barns/atom (b) obtained from the formula for μ_a above the data block for each element
f_1 and f_2	Atomic scattering factor components (dimensionless) calculated from the photoabsorption cross sections by Eqs. (76) and (77) for forward scattering
Atomic Weight	As currently recommended by the International Union of Pure and Applied Chemistry. See J. R. De Laeter and K. G. Heumann, J. Phys. Chem. Ref. Data 20 , 1313 (1991). Used in determination of listed conversion factors [μ_a (b/atom)/ μ (cm^2/g)] and [$E\mu/f_2$] ($\text{keV cm}^2/\text{g}$)
Edge Energies	Energies of absorption edges in the region 10–30,000 eV. The values have been taken from J. A. Bearden and A. F. Burr, Rev. Mod. Phys. 39 , 125 (1967) except as noted: ^a M. Cardona and L. Ley, Eds., <i>Photoemission in Solids. I. General Principles</i> (Springer-Verlag, Berlin, 1978). ^b J. C. Fuggle and N. Martensson, J. Electron Spectrosc. Relat. Phenom. 21 , 275 (1980)
References	References to photoabsorption data used to generate f_2 by Eq. (77) presented at the end of the tables in References for Photoabsorption Data; if no photoabsorption data were available for a given element, a best-fit f_2 curve was obtained by interpolation or extrapolation through Z

TABLE II. Incoherent Scattering Cross Sections, $Z = 2-18$, $E = 1000-30,000$ eV

Line, E	As in Table I
μ_{inc}	Incoherent (Compton) scattering cross section in cm^2/g calculated from Eq. (36) using the analytical expression for the atomic form factor given in Ref. 8; for each element, values are given only for photon energies which are large compared to the electronic binding energies

EXPLANATION OF TABLES continued

TABLE III. Specular Reflectivity for Mirrors: Be, C, Al, Al₂O₃, SiO₂, Ni, Cu, Mo, Pt, and Au

Line, E	As in Table I
θ	Grazing incidence angle in milliradians
$P(\%)$	$100 \times I(\theta)/I_0$, the reflection intensity ratio calculated by Eqs. (54), (55), (56), and (57) for <i>unpolarized</i> incident radiation; this quantity is listed below each θ and plotted vs photon energy

TABLE IV. Bragg Reflection Characteristics for Natural Crystals: Si(422), Ge(422), LiF(220), Si(220), CaF₂(220), Ge(220), LiF(200), Cu(111), Al(111), Si(111), CaF₂(111), Ge(111), C(0002), InSb(111), ADP(200), PET(002), ADP(101), Mica(002), TAP(001), RAP(001), and KAP(001)

d	Distance between crystal planes in Å. The $2d$ values listed here for the acid phthalate analyzers are those measured and recommended by Barrus et al. ⁴⁵ and are corrected for refraction. The other $2d$ values are taken from the compilation by Bertin ²⁰
Line, E, λ	As in Table I
R_m	Integrated reflection efficiency (in milliradians) calculated by the Lorentzian or mosaic crystal model [Eq. (73)] for unpolarized radiation (dot-dashed curve)
R_p	Integrated reflection efficiency (in milliradians) calculated by integration of the modified Darwin-Prins relation [Eq. (26)] for unpolarized radiation (solid curve); numerical integration limits of $\pm 5\omega$, ω being the full width at half-maximum (FWHM) of the reflectivity curve
R_π/R_σ	Ratio of the integrated reflectivity for π polarization to the integrated reflectivity for σ polarization calculated for the modified Darwin-Prins model [Eq. (26)] by numerical integration
$P_\pi(\%)$	Percentage reflectivity at peak, $100 \times I(\theta)/I_0$, given by Eq. (26) for π polarization (solid curve)
$P_\sigma(\%)$	Percentage reflectivity at peak, $100 \times I(\theta)/I_0$, given by Eq. (26) for σ polarization (dashed curve).
ω_π	FWHM in milliradians of rocking curve $I(\theta)$ given by Eq. (26) for π polarization (solid curve)
ω_σ	FWHM in milliradians of rocking curve $I(\theta)$ given by Eq. (26) for σ polarization (dashed curve)
$E/\Delta E_\pi$	Resolving power of the analyzer for π polarization
$E/\Delta E_\sigma$	Resolving power of the analyzer for σ polarization
	The integrated reflectivity data shown in the plots are taken from the following sources:
○	Henke et al., unpublished
+	J. V. Gilfrich, D. B. Brown, and P. G. Burkhalter, <i>Appl. Spectrosc.</i> 29 , 322 (1975)
□	A. L. Zapysov, I. M. Izrailev, V. A. Podgornov, and N. A. Kharvonin, <i>Prib. Tekh. Eksp.</i> 6 , 170 (1982)
◇	A. J. Burek and B. Yaakobi, LLE Report 139 (Jan. 1983)
×	B. Yaakobi, private communication
●	A. J. Burek, D. M. Barrus, and R. L. Blake, <i>Astrophys. J.</i> 191 , 533 (1974)
××	P. G. Burkhalter, J. V. Gilfrich, D. B. Brown, and D. L. Rosen, <i>SPIE</i> 689 , 121 (1986)
△	D. B. Brown, M. Fatemi, and L. Birks, <i>J. Appl. Phys.</i> 45 , 1555 (1974)

TABLE I. Photoabsorption Cross Sections and Atomic Scattering Factors,
 $Z = 1-92, E = 50-30,000 \text{ eV}$
 See page 211 for Explanation of Tables

Hydrogen (H)
 $Z = 1$
 Atomic Weight = 1.008

$\mu_a(\text{barns/atom}) = \mu(\text{cm}^2/\text{gm}) \times 1.67$
 $E(\text{keV})\mu(\text{cm}^2/\text{gm}) = f_2 \times 41746.75$

Line	E(eV)	$\mu(\text{cm}^2/\text{gm})$	f_1	f_2	$\lambda (\text{\AA})$
H	10.2				1215
He I	21.2	1.22e + 6		6.21e - 1	584.3
Na L _{2,3}	30.5	4.05e + 5		2.95e - 1	407.2
Mg L _{2,3}	49.3	9.85e + 4		1.16e - 1	251.5
Al L _{2,3}	72.4	3.10e + 4	1.05	5.38e - 2	171.2
Si L _{2,3}	91.5	1.52e + 4	1.04	3.32e - 2	135.5
Be K	108.5	8.95e + 3	1.03	2.33e - 2	114.3
Sr M ζ	114.0	7.68e + 3	1.03	2.10e - 2	108.8
Y M ζ	132.8	4.78e + 3	1.02	1.52e - 2	93.4
Zr M ζ	151.1	3.19e + 3	1.02	1.15e - 2	82.1
B K α	183.3	1.73e + 3	1.01	7.58e - 3	67.6
Mo M ζ	192.6	1.47e + 3	1.01	6.80e - 3	64.4
Ar L ℓ	220.1	9.62e + 2	1.01	5.07e - 3	56.3
C K α	277.0	4.61e + 2	1.01	3.06e - 3	44.8
Ag M ζ	311.7	3.16e + 2	1.01	2.36e - 3	39.8
N K α	392.4	1.49e + 2	1.00	1.40e - 3	31.6
Ti L α	452.2	9.34e + 1	1.00	1.01e - 3	27.4
V L α	511.3	6.25e + 1	1.00	7.65e - 4	24.2
O K α	524.9	5.73e + 1	1.00	7.21e - 4	23.6
Cr L α	572.8	4.31e + 1	1.00	5.91e - 4	21.6
Mn L α	637.4	3.03e + 1	1.00	4.63e - 4	19.5
F K α	676.8	2.48e + 1	1.00	4.02e - 4	18.3
Fe L α	705.0	2.17e + 1	1.00	3.66e - 4	17.6
Co L α	776.2	1.57e + 1	1.00	2.93e - 4	16.0
Ni L α	851.5	1.16e + 1	1.00	2.36e - 4	14.6
Cu L α	929.7	8.64e + 0	1.00	1.92e - 4	13.3
Zn L α	1011.7	6.52e + 0	1.00	1.58e - 4	12.3
Na K α	1041.0	5.93e + 0	1.00	1.48e - 4	11.9
Ge L α	1188.0	3.82e + 0	1.00	1.09e - 4	10.4
Ni _o K α	1253.6	3.20e + 0	1.00	9.60e - 5	9.9
Al K α	1486.7	1.80e + 0	1.00	6.41e - 5	8.3
Si K α	1740.0	1.06e + 0	1.00	4.43e - 5	7.1
Zr L α	2042.4	6.19e - 1	1.00	3.03e - 5	6.1
Mo L α	2293.2	4.18e - 1	1.00	2.30e - 5	5.4
Cl K α	2622.4	2.65e - 1	1.00	1.66e - 5	4.7
Ag L α	2984.3	1.70e - 1	1.00	1.22e - 5	4.2
Ca K α	3691.7	8.20e - 2	1.00	7.25e - 6	3.4
Ti K α	4510.8	4.13e - 2	1.00	4.46e - 6	2.7
V K α	4952.2	3.00e - 2	1.00	3.56e - 6	2.5
Cr K α	5414.7	2.22e - 2	1.00	2.88e - 6	2.3
Mn K α	5898.8	1.66e - 2	1.00	2.34e - 6	2.1
Co K α	6930.3	9.58e - 3	1.00	1.59e - 6	1.8
Ni K α	7478.2	7.40e - 3	1.00	1.33e - 6	1.7
Cu K α	8047.8	5.76e - 3	1.00	1.11e - 6	1.5
Ge K α	9886.4	2.85e - 3	1.00	6.76e - 7	1.3
Y K α	14988.0	6.79e - 4	1.00	2.44e - 7	0.8
Mo K α	17479.0	3.98e - 4	1.00	1.67e - 7	0.7
Pd K α	21177.0	2.04e - 4	1.00	1.03e - 7	0.6
Sn K α	25271.0	1.10e - 4	1.00	6.67e - 8	0.5
Xe K α	29779.0	6.26e - 5	1.00	4.46e - 8	0.4

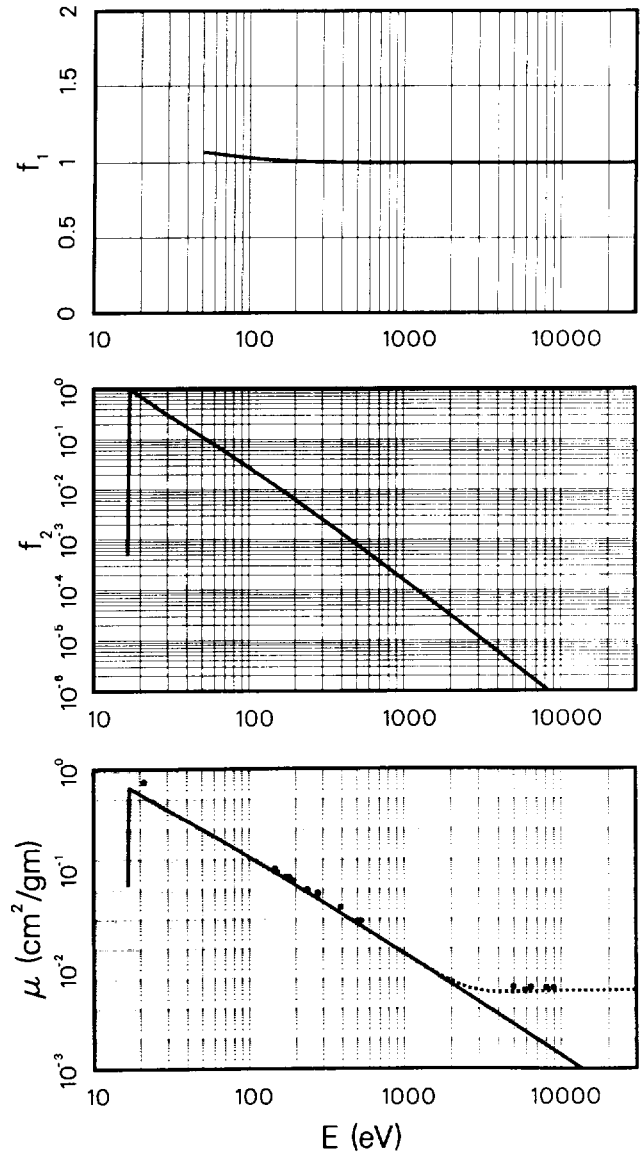

Edge Energies
 K 13.6 eV

References: 19, 111, 143, 150, 161.

TABLE I. Photoabsorption Cross Sections and Atomic Scattering Factors,
 $Z = 1-92, E = 50-30,000 \text{ eV}$
 See page 211 for Explanation of Tables

$\mu_a(\text{barns/atom}) = \mu(\text{cm}^2/\text{gm}) \times 6.65$
 $E(\text{keV})\mu(\text{cm}^2/\text{gm}) = f_2 \times 10512.72$

Helium (He)
 $Z = 2$
 Atomic Weight = 4.003

Line	E(eV)	$\mu(\text{cm}^2/\text{gm})$	f_1	f_2	$\lambda(\text{\AA})$
H	10.2				1215
He I	21.2				584.3
Na $L_{2,3}$	30.5	8.14e + 5		2.36e + 0	407.2
Mg $L_{2,3}$	49.3	3.21e + 5		1.51e + 0	251.5
Al $L_{2,3}$	72.4	1.37e + 5	2.13	9.41e - 1	171.2
Si $L_{2,3}$	91.5	7.98e + 4	2.20	6.94e - 1	135.5
Be K	108.5	5.20e + 4	2.23	5.36e - 1	114.3
Sr $M\zeta$	114.0	4.54e + 4	2.23	4.92e - 1	108.8
Y $M\zeta$	132.8	2.96e + 4	2.22	3.74e - 1	93.4
Zr $M\zeta$	151.1	2.02e + 4	2.20	2.90e - 1	82.1
B $K\alpha$	183.3	1.15e + 4	2.16	2.01e - 1	67.6
Mo $M\zeta$	192.6	9.98e + 3	2.16	1.83e - 1	64.4
Ar $L\ell$	220.1	6.76e + 3	2.13	1.42e - 1	56.3
C $K\alpha$	277.0	3.34e + 3	2.10	8.79e - 2	44.8
Ag $M\zeta$	311.7	2.32e + 3	2.09	6.88e - 2	39.8
N $K\alpha$	392.4	1.14e + 3	2.06	4.25e - 2	31.6
Ti $L\alpha$	452.2	7.28e + 2	2.05	3.13e - 2	27.4
V $L\alpha$	511.3	4.94e + 2	2.04	2.40e - 2	24.2
O $K\alpha$	524.9	4.55e + 2	2.04	2.27e - 2	23.6
Cr $L\alpha$	572.8	3.45e + 2	2.03	1.88e - 2	21.6
Mn $L\alpha$	637.4	2.46e + 2	2.03	1.49e - 2	19.5
F $K\alpha$	676.8	2.01e + 2	2.03	1.29e - 2	18.3
Fe $L\alpha$	705.0	1.78e + 2	2.02	1.19e - 2	17.6
Co $L\alpha$	776.2	1.31e + 2	2.02	9.67e - 3	16.0
Ni $L\alpha$	851.5	9.73e + 1	2.02	7.88e - 3	14.6
Cu $L\alpha$	929.7	7.39e + 1	2.01	6.53e - 3	13.3
Zn $L\alpha$	1011.7	5.68e + 1	2.01	5.46e - 3	12.3
Na $K\alpha$	1041.0	5.18e + 1	2.01	5.13e - 3	11.9
Ge $L\alpha$	1188.0	3.40e + 1	2.01	3.84e - 3	10.4
Mg $K\alpha$	1253.6	2.86e + 1	2.01	3.41e - 3	9.9
Al $K\alpha$	1486.7	1.68e + 1	2.01	2.37e - 3	8.3
Si $K\alpha$	1740.0	9.99e + 0	2.00	1.65e - 3	7.1
Zr $L\alpha$	2042.4	5.84e + 0	2.00	1.13e - 3	6.1
Mo $L\alpha$	2293.2	3.93e + 0	2.00	8.58e - 4	5.4
Cl $K\alpha$	2622.4	2.47e + 0	2.00	6.17e - 4	4.7
Ag $L\alpha$	2984.3	1.58e + 0	2.00	4.47e - 4	4.2
Ca $K\alpha$	3691.7	7.48e - 1	2.00	2.63e - 4	3.4
Ti $K\alpha$	4510.8	3.74e - 1	2.00	1.61e - 4	2.7
V $K\alpha$	4952.2	2.72e - 1	2.00	1.28e - 4	2.5
Cr $K\alpha$	5414.7	2.01e - 1	2.00	1.03e - 4	2.3
Mn $K\alpha$	5898.8	1.50e - 1	2.00	8.41e - 5	2.1
Co $K\alpha$	6930.3	8.69e - 2	2.00	5.73e - 5	1.8
Ni $K\alpha$	7478.2	6.72e - 2	2.00	4.78e - 5	1.7
Cu $K\alpha$	8047.8	5.25e - 2	2.00	4.02e - 5	1.5
Ge $K\alpha$	9886.4	2.63e - 2	2.00	2.47e - 5	1.3
Y $K\alpha$	14988.0	6.51e - 3	2.00	9.28e - 6	0.8
Mo $K\alpha$	17479.0	3.88e - 3	2.00	6.44e - 6	0.7
Pd $K\alpha$	21177.0	2.06e - 3	2.00	4.16e - 6	0.6
Sn $K\alpha$	25271.0	1.11e - 3	2.00	2.68e - 6	0.5
Xe $K\alpha$	29779.0	6.30e - 4	2.00	1.79e - 6	0.4

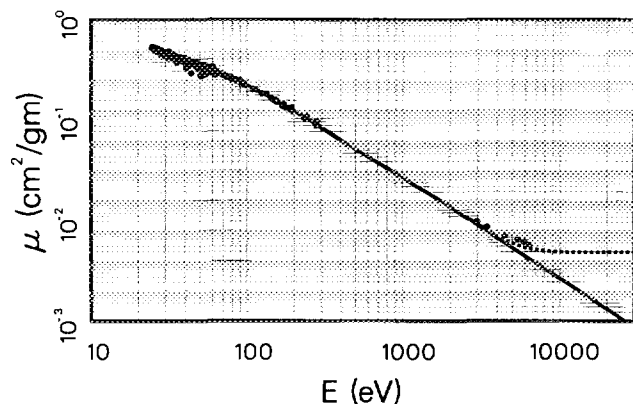
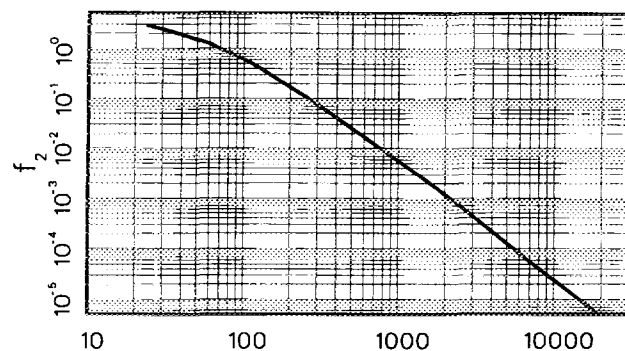
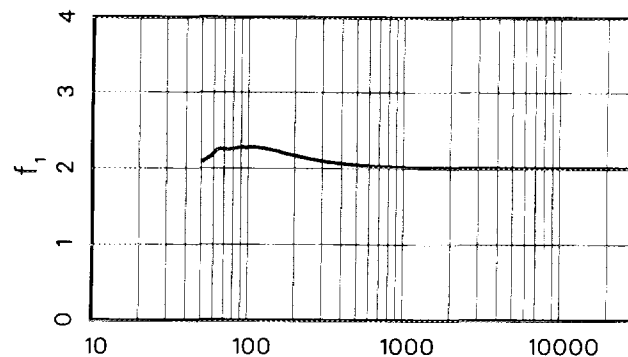

Edge Energies
 K 24.6 eV^a

References: 11, 38, 46, 56, 78, 84, 88, 95, 111, 143, 162, 194, 209.

TABLE I. Photoabsorption Cross Sections and Atomic Scattering Factors,
 $Z = 1-92$, $E = 50-30,000$ eV
 See page 211 for Explanation of Tables

Lithium (Li)
 $Z = 3$

Atomic Weight = 6.941

$\mu_a(\text{barns/atom}) = \mu(\text{cm}^2/\text{gm}) \times 11.53$
 $E(\text{keV})\mu(\text{cm}^2/\text{gm}) = f_2 \times 6062.27$

Line	E(eV)	$\mu(\text{cm}^2/\text{gm})$	f_1	f_2	$\lambda(\text{\AA})$
H	10.2	6.99e+4		1.18e-1	1215
He I	21.2	3.90e+4		1.37e-1	584.3
Na L _{2,3}	30.5	2.26e+4		1.14e-1	407.2
Mg L _{2,3}	49.3	8.55e+3		6.95e-2	251.5
Al L _{2,3}	72.4	2.41e+5	1.36	2.88e+0	171.2
Si L _{2,3}	91.5	1.91e+5	2.53	2.88e+0	135.5
Be K	108.5	1.13e+5	2.99	2.03e+0	114.3
Sr M ζ	114.0	1.02e+5	3.04	1.91e+0	108.8
Y M ζ	132.8	7.06e+4	3.20	1.55e+0	93.4
Zr M ζ	151.1	5.11e+4	3.27	1.27e+0	82.1
B K α	183.3	3.15e+4	3.32	9.53e-1	67.6
Mo M ζ	192.6	2.76e+4	3.33	8.76e-1	64.4
Ar L ℓ	220.1	1.94e+4	3.33	7.04e-1	56.3
C K α	277.0	1.03e+4	3.29	4.71e-1	44.8
Ag M ζ	311.7	7.36e+3	3.26	3.78e-1	39.8
N K α	392.4	3.81e+3	3.21	2.46e-1	31.6
Ti L α	452.2	2.51e+3	3.18	1.87e-1	27.4
V L α	511.3	1.73e+3	3.15	1.46e-1	24.2
O K α	524.9	1.60e+3	3.15	1.39e-1	23.6
Cr L α	572.8	1.23e+3	3.13	1.16e-1	21.6
Mn L α	637.4	8.91e+2	3.11	9.37e-2	19.5
F K α	676.8	7.37e+2	3.10	8.22e-2	18.3
Fe L α	705.0	6.54e+2	3.10	7.60e-2	17.6
Co L α	776.2	4.87e+2	3.09	6.24e-2	16.0
Ni L α	851.5	3.66e+2	3.07	5.14e-2	14.6
Cu L α	929.7	2.79e+2	3.06	4.29e-2	13.3
Zn L α	1011.7	2.15e+2	3.06	3.59e-2	12.3
Na K α	1041.0	1.97e+2	3.05	3.38e-2	11.9
Ge L α	1188.0	1.31e+2	3.04	2.56e-2	10.4
Mg K α	1253.6	1.11e+2	3.04	2.29e-2	9.9
Al K α	1486.7	6.47e+1	3.03	1.59e-2	8.3
Si K α	1740.0	3.92e+1	3.02	1.12e-2	7.1
Zr L α	2042.4	2.43e+1	3.02	8.20e-3	6.1
Mo L α	2293.2	1.69e+1	3.01	6.39e-3	5.4
Cl K α	2622.4	1.11e+1	3.01	4.78e-3	4.7
Ag L α	2984.3	7.38e+0	3.01	3.63e-3	4.2
Ca K α	3691.7	3.87e+0	3.01	2.35e-3	3.4
Ti K α	4510.8	2.10e+0	3.00	1.56e-3	2.7
V K α	4952.2	1.58e+0	3.00	1.29e-3	2.5
Cr K α	5414.7	1.20e+0	3.00	1.07e-3	2.3
Mn K α	5898.8	9.42e-1	3.00	9.17e-4	2.1
Co K α	6930.3	6.08e-1	3.00	6.95e-4	1.8
Ni K α	7478.2	4.94e-1	3.00	6.10e-4	1.7
Cu K α	8047.8	3.97e-1	3.00	5.27e-4	1.5
Ge K α	9886.4	2.20e-1	3.00	3.59e-4	1.3
Y K α	14988.0	5.51e-2	3.00	1.36e-4	0.8
Mo K α	17479.0	3.28e-2	3.00	9.47e-5	0.7
Pd K α	21177.0	1.71e-2	3.00	5.97e-5	0.6
Sn K α	25271.0	9.30e-3	3.00	3.88e-5	0.5
Xe K α	29779.0	5.29e-3	3.00	2.60e-5	0.4

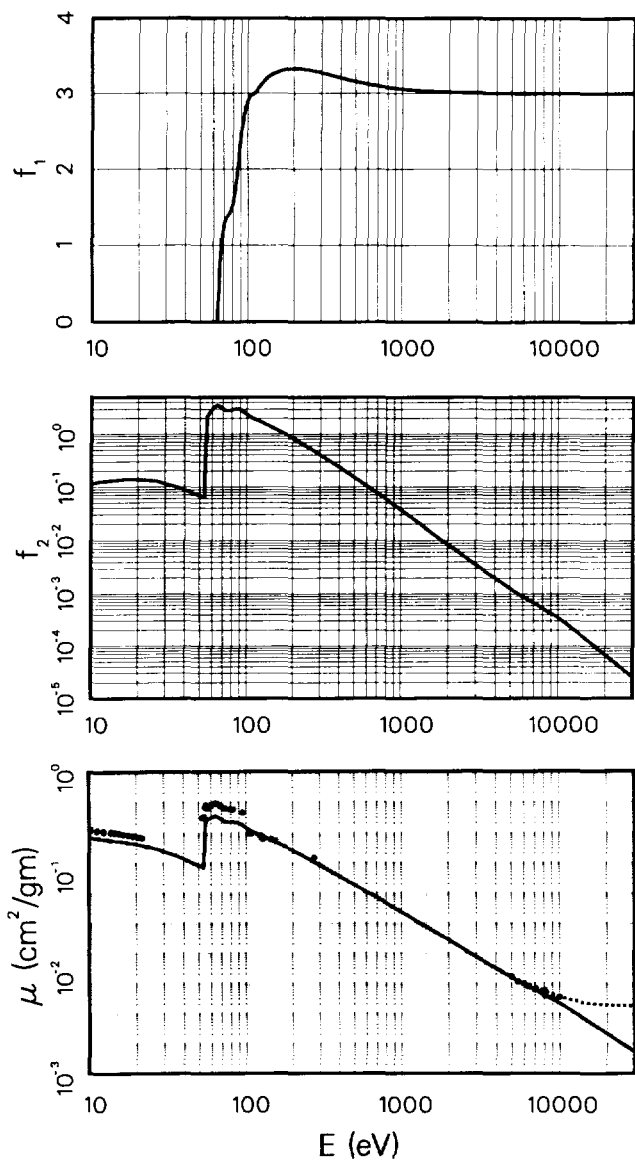

Edge Energies
 K 54.7 eV^a

References: 42, 53, 60, 91, 112, 127, 131, 147.

TABLE I. Photoabsorption Cross Sections and Atomic Scattering Factors,
 $Z = 1-92$, $E = 50-30,000$ eV
 See page 211 for Explanation of Tables

Beryllium (Be)
 $Z = 4$

Atomic Weight = 9.012

μ_a (barns/atom) = μ (cm²/gm) \times 14.97
 E (keV) μ (cm²/gm) = $f_2 \times 4669.04$

Line	E(eV)	μ (cm ² /gm)	f_1	f_2	λ (Å)
H	10.2	1.88e + 5		4.10e - 1	1215
He I	21.2	1.13e + 5		5.15e - 1	584.3
Na L _{2,3}	30.5	6.71e + 4		4.38e - 1	407.2
Mg L _{2,3}	49.3	3.28e + 4		3.46e - 1	251.5
Al L _{2,3}	72.4	1.55e + 4	1.63	2.41e - 1	171.2
Si L _{2,3}	91.5	9.40e + 3	1.12	1.84e - 1	135.5
Be K	108.5	5.99e + 3	-0.84	1.39e - 1	114.3
Sr M ζ	114.0	1.23e + 5	-1.26	3.00e + 0	108.8
Y M ζ	132.8	1.52e + 5	2.57	4.33e + 0	93.4
Zr M ζ	151.1	8.99e + 4	3.06	2.91e + 0	82.1
B K α	183.3	6.06e + 4	3.73	2.38e + 0	67.6
Mo M ζ	192.6	5.41e + 4	3.85	2.23e + 0	64.4
Ar L ℓ	220.1	3.97e + 4	4.08	1.87e + 0	56.3
C K α	277.0	2.21e + 4	4.31	1.31e + 0	44.8
Ag M ζ	311.7	1.62e + 4	4.34	1.08e + 0	39.8
N K α	392.4	8.86e + 3	4.34	7.44e - 1	31.6
Ti L α	452.2	5.96e + 3	4.32	5.78e - 1	27.4
V L α	511.3	4.22e + 3	4.29	4.62e - 1	24.2
O K α	524.9	3.92e + 3	4.29	4.41e - 1	23.6
Cr L α	572.8	3.06e + 3	4.27	3.76e - 1	21.6
Mn L α	637.4	2.25e + 3	4.24	3.08e - 1	19.5
F K α	676.8	1.88e + 3	4.23	2.73e - 1	18.3
Fe L α	705.0	1.68e + 3	4.22	2.54e - 1	17.6
Co L α	776.2	1.27e + 3	4.19	2.11e - 1	16.0
Ni L α	851.5	9.63e + 2	4.17	1.76e - 1	14.6
Cu L α	929.7	7.44e + 2	4.15	1.48e - 1	13.3
Zn L α	1011.7	5.78e + 2	4.14	1.25e - 1	12.3
Na K α	1041.0	5.31e + 2	4.13	1.18e - 1	11.9
Ge L α	1188.0	3.58e + 2	4.11	9.12e - 2	10.4
Mg K α	1253.6	3.05e + 2	4.10	8.20e - 2	9.9
Al K α	1486.7	1.84e + 2	4.08	5.85e - 2	8.3
Si K α	1740.0	1.14e + 2	4.06	4.25e - 2	7.1
Zr L α	2042.4	6.99e + 1	4.05	3.06e - 2	6.1
Mo L α	2293.2	4.88e + 1	4.04	2.40e - 2	5.4
Cl K α	2622.4	3.22e + 1	4.03	1.81e - 2	4.7
Ag L α	2984.3	2.15e + 1	4.03	1.38e - 2	4.2
Ca K α	3691.7	1.10e + 1	4.02	8.68e - 3	3.4
Ti K α	4510.8	5.80e + 0	4.01	5.60e - 3	2.7
V K α	4952.2	4.30e + 0	4.01	4.56e - 3	2.5
Cr K α	5414.7	3.23e + 0	4.01	3.74e - 3	2.3
Mn K α	5898.8	2.45e + 0	4.01	3.09e - 3	2.1
Co K α	6930.3	1.45e + 0	4.01	2.15e - 3	1.8
Ni K α	7478.2	1.13e + 0	4.00	1.81e - 3	1.7
Cu K α	8047.8	8.92e - 1	4.00	1.54e - 3	1.5
Ge K α	9886.4	4.55e - 1	4.00	9.63e - 4	1.3
Y K α	14988.0	1.16e - 1	4.00	3.71e - 4	0.8
Mo K α	17479.0	6.94e - 2	4.00	2.60e - 4	0.7
Pd K α	21177.0	3.66e - 2	4.00	1.66e - 4	0.6
Sn K α	25271.0	2.03e - 2	4.00	1.10e - 4	0.5
Xe K α	29779.0	1.18e - 2	4.00	7.51e - 5	0.4

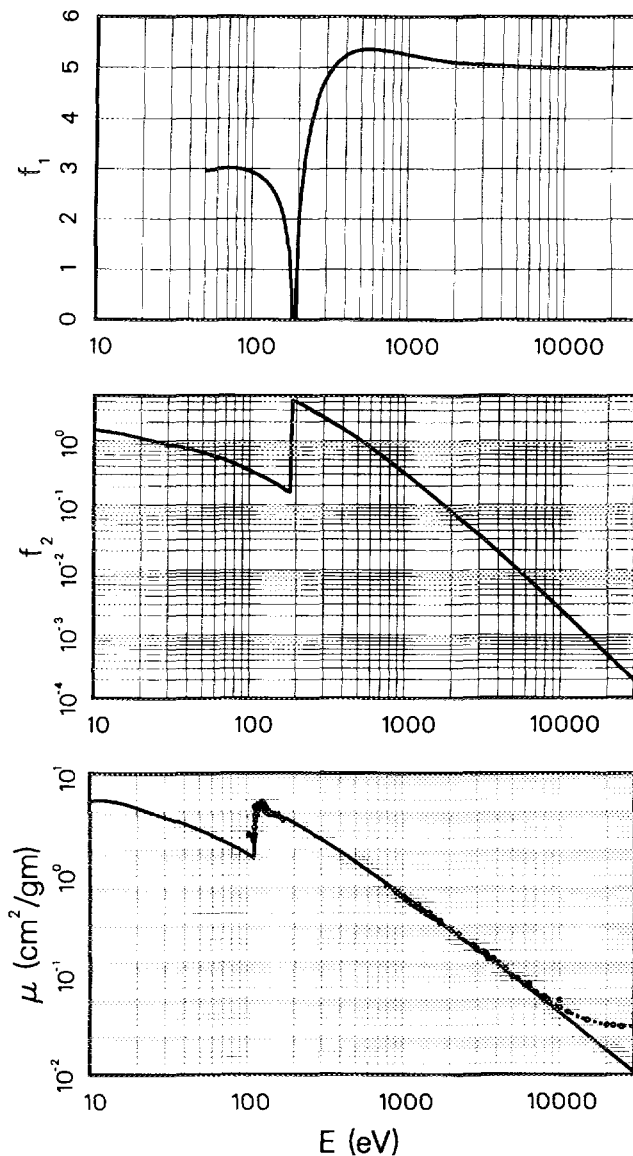

Edge Energies
 K 111.5 eV^a

References: 33, 36, 72, 73, 76, 80, 95, 131, 138, 191.

TABLE I. Photoabsorption Cross Sections and Atomic Scattering Factors,
 $Z = 1-92$, $E = 50-30,000$ eV
 See page 211 for Explanation of Tables

$$\mu_a(\text{barns/atom}) = \mu(\text{cm}^2/\text{gm}) \times 17.95$$

$$E(\text{keV})\mu(\text{cm}^2/\text{gm}) = f_2 \times 3892.17$$

Boron (B)
 $Z = 5$
 Atomic Weight = 10.811

Line	E(eV)	$\mu(\text{cm}^2/\text{gm})$	f_1	f_2	$\lambda(\text{\AA})$
H	10.2	5.64e + 5		1.48e + 0	1215
He I	21.2	1.94e + 5		1.06e + 0	584.3
Na L _{2,3}	30.5	1.10e + 5		8.64e - 1	407.2
Mg L _{2,3}	49.3	5.23e + 4		6.63e - 1	251.5
Al L _{2,3}	72.4	2.61e + 4	3.01	4.86e - 1	171.2
Si L _{2,3}	91.5	1.63e + 4	2.97	3.83e - 1	135.5
Be K	108.5	1.13e + 4	2.87	3.14e - 1	114.3
Sr M ζ	114.0	1.02e + 4	2.83	2.98e - 1	108.8
Y M ζ	132.8	7.23e + 3	2.63	2.47e - 1	93.4
Zr M ζ	151.1	5.38e + 3	2.30	2.09e - 1	82.1
B K α	183.3	3.35e + 3	0.04	1.58e - 1	67.6
Mo M ζ	192.6	8.37e + 4	-0.17	4.14e + 0	64.4
Ar L l	220.1	6.29e + 4	3.21	3.56e + 0	56.3
C K α	277.0	3.70e + 4	4.57	2.63e + 0	44.8
Ag M ζ	311.7	2.77e + 4	4.89	2.22e + 0	39.8
N K α	392.4	1.58e + 4	5.21	1.59e + 0	31.6
Ti L α	452.2	1.10e + 4	5.31	1.28e + 0	27.4
V L α	511.3	7.95e + 3	5.34	1.04e + 0	24.2
O K α	524.9	7.41e + 3	5.35	9.99e - 1	23.6
Cr L α	572.8	5.86e + 3	5.35	8.63e - 1	21.6
Mn L α	637.4	4.38e + 3	5.35	7.18e - 1	19.5
F K α	676.8	3.68e + 3	5.34	6.40e - 1	18.3
Fe L α	705.0	3.31e + 3	5.33	5.99e - 1	17.6
Co L α	776.2	2.53e + 3	5.31	5.05e - 1	16.0
Ni L α	851.5	1.95e + 3	5.29	4.26e - 1	14.6
Cu L α	929.7	1.51e + 3	5.26	3.61e - 1	13.3
Zn L α	1011.7	1.19e + 3	5.24	3.09e - 1	12.3
Na K α	1041.0	1.09e + 3	5.24	2.92e - 1	11.9
Ge L α	1188.0	7.41e + 2	5.20	2.26e - 1	10.4
Mg K α	1253.6	6.33e + 2	5.19	2.04e - 1	9.9
Al K α	1486.7	3.83e + 2	5.15	1.46e - 1	8.3
Si K α	1740.0	2.39e + 2	5.12	1.07e - 1	7.1
Zr L α	2042.4	1.47e + 2	5.10	7.73e - 2	6.1
Mo L α	2293.2	1.04e + 2	5.08	6.10e - 2	5.4
Cl K α	2622.4	6.86e + 1	5.07	4.63e - 2	4.7
Ag L α	2984.3	4.60e + 1	5.05	3.53e - 2	4.2
Ca K α	3691.7	2.37e + 1	5.04	2.25e - 2	3.4
Ti K α	4510.8	1.26e + 1	5.03	1.46e - 2	2.7
V K α	4952.2	9.37e + 0	5.02	1.19e - 2	2.5
Cr K α	5414.7	7.05e + 0	5.02	9.81e - 3	2.3
Mn K α	5898.8	5.36e + 0	5.02	8.13e - 3	2.1
Co K α	6930.3	3.20e + 0	5.01	5.69e - 3	1.8
Ni K α	7478.2	2.50e + 0	5.01	4.81e - 3	1.7
Cu K α	8047.8	1.97e + 0	5.01	4.08e - 3	1.5
Ge K α	9886.4	1.01e + 0	5.01	2.55e - 3	1.3
Y K α	14988.0	2.51e - 1	5.00	9.67e - 4	0.8
Mo K α	17479.0	1.49e - 1	5.00	6.70e - 4	0.7
Pd K α	21177.0	7.80e - 2	5.00	4.25e - 4	0.6
Sn K α	25271.0	4.31e - 2	5.00	2.80e - 4	0.5
Xe K α	29779.0	2.50e - 2	5.00	1.91e - 4	0.4

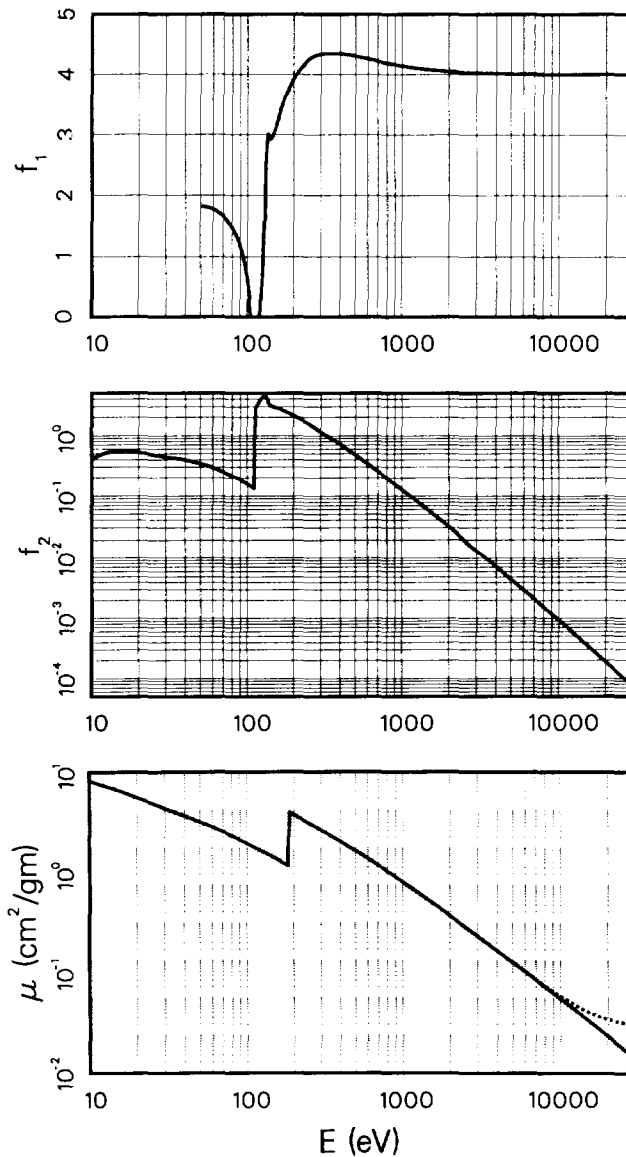

Edge Energies
 K 188. eV*

TABLE I. Photoabsorption Cross Sections and Atomic Scattering Factors,
 $Z = 1-92$, $E = 50-30,000$ eV
 See page 211 for Explanation of Tables

Carbon (C)
 $Z = 6$

Atomic Weight = 12.011

$\mu_a(\text{barns/atom}) = \mu(\text{cm}^2/\text{gm}) \times 19.95$
 $E(\text{keV})\mu(\text{cm}^2/\text{gm}) = f_2 \times 3503.31$

Line	E(eV)	$\mu(\text{cm}^2/\text{gm})$	f_1	f_2	$\lambda(\text{\AA})$
H	10.2	2.96e+5		8.62e-1	1215
He I	21.2	6.03e+5		3.65e+0	584.3
Na L _{2,3}	30.5	3.01e+5		2.62e+0	407.2
Mg L _{2,3}	49.3	1.02e+5		1.44e+0	251.5
Al L _{2,3}	72.4	4.84e+4	4.25	1.00e+0	171.2
Si L _{2,3}	91.5	2.94e+4	4.26	7.69e-1	135.5
Be K	108.5	2.05e+4	4.24	6.35e-1	114.3
Sr M ζ	114.0	1.85e+4	4.23	6.01e-1	108.8
Y M ζ	132.8	1.33e+4	4.18	5.06e-1	93.4
Zr M ζ	151.1	9.94e+3	4.11	4.29e-1	82.1
B K α	183.3	6.40e+3	3.94	3.35e-1	67.6
Mo M ζ	192.6	5.62e+3	3.87	3.09e-1	64.4
Ar L l	220.1	3.89e+3	3.59	2.45e-1	56.3
C K α	277.0	1.96e+3	1.08	1.55e-1	44.8
Ag M ζ	311.7	4.21e+3	3.49	3.74e+0	39.8
N K α	392.4	2.50e+4	5.41	2.80e+0	31.6
Ti L α	452.2	1.76e+4	5.87	2.27e+0	27.4
V L α	511.3	1.29e+4	6.09	1.89e+0	24.2
O K α	524.9	1.21e+4	6.12	1.81e+0	23.6
Cr L α	572.8	9.71e+3	6.21	1.59e+0	21.6
Mn L α	637.4	7.41e+3	6.28	1.35e+0	19.5
F K α	676.8	6.37e+3	6.30	1.23e+0	18.3
Fe L α	705.0	5.77e+3	6.32	1.16e+0	17.6
Co L α	776.2	4.45e+3	6.35	9.86e-1	16.0
Ni L α	851.5	3.46e+3	6.35	8.40e-1	14.6
Cu L α	929.7	2.71e+3	6.34	7.20e-1	13.3
Zn L α	1011.7	2.15e+3	6.33	6.20e-1	12.3
Na K α	1041.0	1.98e+3	6.32	5.89e-1	11.9
Ge L α	1188.0	1.37e+3	6.30	4.63e-1	10.4
Mg K α	1253.6	1.17e+3	6.28	4.20e-1	9.9
Al K α	1486.7	7.18e+2	6.24	3.05e-1	8.3
Si K α	1740.0	4.55e+2	6.20	2.26e-1	7.1
Zr L α	2042.4	2.84e+2	6.16	1.66e-1	6.1
Mo L α	2293.2	2.02e+2	6.14	1.32e-1	5.4
Cl K α	2622.4	1.35e+2	6.12	1.01e-1	4.7
Ag L α	2984.3	9.19e+1	6.10	7.83e-2	4.2
Ca K α	3691.7	4.82e+1	6.07	5.08e-2	3.4
Ti K α	4510.8	2.60e+1	6.05	3.35e-2	2.7
V K α	4952.2	1.95e+1	6.04	2.75e-2	2.5
Cr K α	5414.7	1.47e+1	6.04	2.28e-2	2.3
Mn K α	5898.8	1.12e+1	6.03	1.89e-2	2.1
Co K α	6930.3	6.75e+0	6.02	1.33e-2	1.8
Ni K α	7478.2	5.29e+0	6.02	1.13e-2	1.7
Cu K α	8047.8	4.18e+0	6.02	9.60e-3	1.5
Ge K α	9886.4	2.14e+0	6.01	6.03e-3	1.3
Y K α	14988.0	5.32e-1	6.00	2.27e-3	0.8
Mo K α	17479.0	3.17e-1	6.00	1.58e-3	0.7
Pd K α	21177.0	1.67e-1	6.00	1.01e-3	0.6
Sn K α	25271.0	9.12e-2	6.00	6.58e-4	0.5
Xe K α	29779.0	5.23e-2	6.00	4.45e-4	0.4

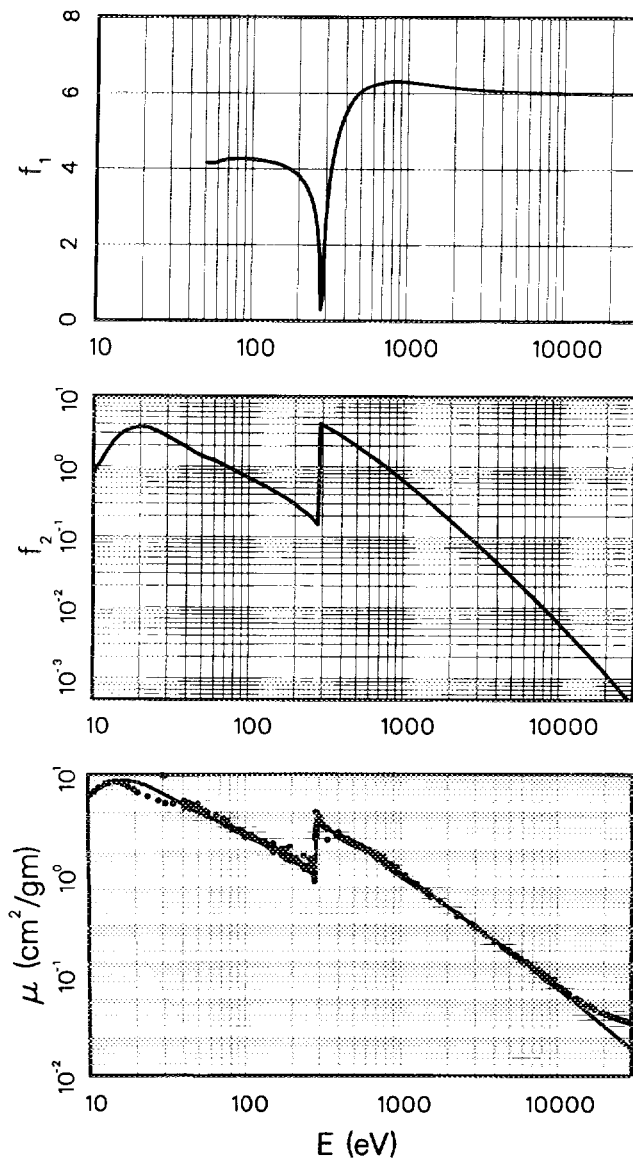

Edge Energies

K 284.2 eV^a

References: 2, 4, 6, 9, 11, 18, 21, 28, 30, 33, 37, 44, 45, 80, 85, 87, 94, 95, 111, 120, 121, 128, 131, 138, 143, 144, 176, 182, 185, 213, 216, 222, 225, 230, 233.

TABLE I. Photoabsorption Cross Sections and Atomic Scattering Factors,
 $Z = 1-92$, $E = 50-30,000$ eV
 See page 211 for Explanation of Tables

μ_a (barns/atom) = μ (cm²/gm) \times 23.26
 E (keV) μ (cm²/gm) = $f_2 \times 3004.14$

Nitrogen (N)
 $Z = 7$
 Atomic Weight = 14.007

Line	E(eV)	μ (cm ² /gm)	f_1	f_2	λ (Å)
H	10.2	2.04e + 5		6.92e - 1	1215
He I	21.2	6.65e + 5		4.69e + 0	584.3
Na L _{2,3}	30.5	4.25e + 5		4.31e + 0	407.2
Mg L _{2,3}	49.3	1.73e + 5		2.84e + 0	251.5
Al L _{2,3}	72.4	8.52e + 4	5.20	2.05e + 0	171.2
Si L _{2,3}	91.5	5.26e + 4	5.38	1.60e + 0	135.5
Be K	108.5	3.64e + 4	5.45	1.32e + 0	114.3
Sr M ζ	114.0	3.27e + 4	5.45	1.24e + 0	108.8
Y M ζ	132.8	2.34e + 4	5.47	1.03e + 0	93.4
Zr M ζ	151.1	1.75e + 4	5.46	8.78e - 1	82.1
B K α	183.3	1.09e + 4	5.41	6.65e - 1	67.6
Mo M ζ	192.6	9.62e + 3	5.39	6.17e - 1	64.4
Ar L ℓ	220.1	6.86e + 3	5.30	5.03e - 1	56.3
C K α	277.0	3.77e + 3	5.04	3.47e - 1	44.8
Ag M ζ	311.7	2.76e + 3	4.80	2.87e - 1	39.8
N K α	392.4	1.32e + 3	2.98	1.73e - 1	31.6
Ti L α	452.2	2.45e + 4	4.74	3.68e + 0	27.4
V L α	511.3	1.84e + 4	5.96	3.14e + 0	24.2
O K α	524.9	1.73e + 4	6.12	3.03e + 0	23.6
Cr L α	572.8	1.41e + 4	6.56	2.69e + 0	21.6
Mn L α	637.4	1.07e + 4	6.90	2.28e + 0	19.5
F K α	676.8	9.22e + 3	7.03	2.08e + 0	18.3
Fe L α	705.0	8.31e + 3	7.10	1.95e + 0	17.6
Co L α	776.2	6.49e + 3	7.22	1.68e + 0	16.0
Ni L α	851.5	5.07e + 3	7.30	1.44e + 0	14.6
Cu L α	929.7	4.02e + 3	7.33	1.24e + 0	13.3
Zn L α	1011.7	3.20e + 3	7.35	1.08e + 0	12.3
Na K α	1041.0	2.97e + 3	7.36	1.03e + 0	11.9
Ge L α	1188.0	2.07e + 3	7.36	8.19e - 1	10.4
Mg K α	1253.6	1.79e + 3	7.35	7.46e - 1	9.9
Al K α	1486.7	1.11e + 3	7.32	5.48e - 1	8.3
Si K α	1740.0	7.08e + 2	7.28	4.10e - 1	7.1
Zr L α	2042.4	4.46e + 2	7.24	3.03e - 1	6.1
Mo L α	2293.2	3.18e + 2	7.21	2.43e - 1	5.4
Cl K α	2622.4	2.14e + 2	7.18	1.87e - 1	4.7
Ag L α	2984.3	1.46e + 2	7.15	1.45e - 1	4.2
Ca K α	3691.7	7.69e + 1	7.11	9.45e - 2	3.4
Ti K α	4510.8	4.17e + 1	7.08	6.26e - 2	2.7
V K α	4952.2	3.13e + 1	7.07	5.16e - 2	2.5
Cr K α	5414.7	2.37e + 1	7.06	4.28e - 2	2.3
Mn K α	5898.8	1.82e + 1	7.05	3.57e - 2	2.1
Co K α	6930.3	1.10e + 1	7.04	2.54e - 2	1.8
Ni K α	7478.2	8.65e + 0	7.04	2.15e - 2	1.7
Cu K α	8047.8	6.85e + 0	7.03	1.84e - 2	1.5
Ge K α	9886.4	3.56e + 0	7.02	1.17e - 2	1.3
Y K α	14988.0	9.29e - 1	7.01	4.63e - 3	0.8
Mo K α	17479.0	5.60e - 1	7.01	3.26e - 3	0.7
Pd K α	21177.0	2.98e - 1	7.00	2.10e - 3	0.6
Sn K α	25271.0	1.67e - 1	7.00	1.40e - 3	0.5
Xe K α	29779.0	9.75e - 2	7.00	9.67e - 4	0.4

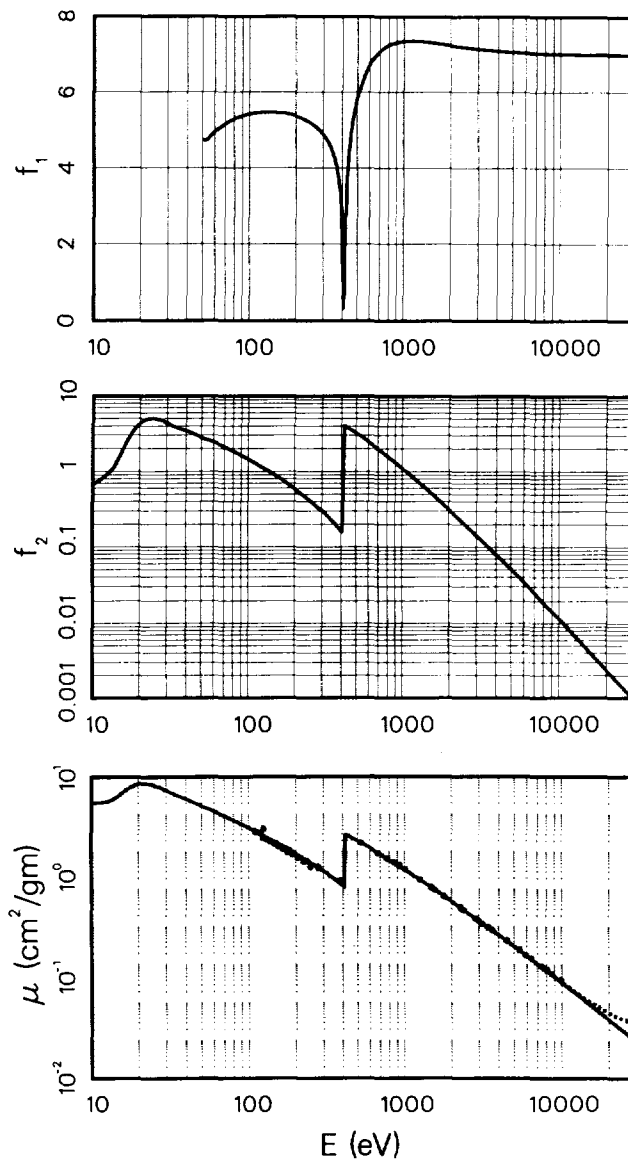

Edge Energies
 K 409.9 eV^a L_I 37.3 eV^a

References: 6, 9, 11, 15, 18, 94, 95, 111, 143, 176, 184, 207.

TABLE I. Photoabsorption Cross Sections and Atomic Scattering Factors,
 $Z = 1-92$, $E = 50-30,000$ eV
 See page 211 for Explanation of Tables

$\mu_a(\text{barns/atom}) = \mu(\text{cm}^2/\text{gm}) \times 26.57$
 $E(\text{keV})\mu(\text{cm}^2/\text{gm}) = f_2 \times 2629.99$

Oxygen (O)
 $Z = 8$
 Atomic Weight = 15.999

Line	E(eV)	$\mu(\text{cm}^2/\text{gm})$	f_1	f_2	$\lambda(\text{\AA})$
H	10.2	1.82e+5		7.06e-1	1215
He I	21.2	4.97e+5		4.01e+0	584.3
Na L _{2,3}	30.5	4.04e+5		4.68e+0	407.2
Mg L _{2,3}	49.3	2.35e+5		4.41e+0	251.5
Al L _{2,3}	72.4	1.20e+5	5.51	3.30e+0	171.2
Si L _{2,3}	91.5	7.97e+4	5.96	2.77e+0	135.5
Be K	108.5	5.69e+4	6.29	2.35e+0	114.3
Sr M ζ	114.0	5.11e+4	6.34	2.21e+0	108.8
Y M ζ	132.8	3.66e+4	6.45	1.85e+0	93.4
Zr M ζ	151.1	2.79e+4	6.50	1.60e+0	82.1
B K α	183.3	1.85e+4	6.59	1.29e+0	67.6
Mo M ζ	192.6	1.60e+4	6.61	1.17e+0	64.4
Ar L ℓ	220.1	1.10e+4	6.57	9.18e-1	56.3
C K α	277.0	6.04e+3	6.38	6.36e-1	44.8
Ag M ζ	311.7	4.50e+3	6.27	5.33e-1	39.8
N K α	392.4	2.52e+3	5.92	3.77e-1	31.6
Ti L α	452.2	1.76e+3	5.47	3.02e-1	27.4
V L α	511.3	1.28e+3	4.35	2.49e-1	24.2
O K α	524.9	1.20e+3	3.58	2.39e-1	23.6
Cr L α	572.8	1.87e+4	4.82	4.08e+0	21.6
Mn L α	637.4	1.45e+4	6.58	3.51e+0	19.5
F K α	676.8	1.24e+4	7.05	3.19e+0	18.3
Fe L α	705.0	1.13e+4	7.28	3.02e+0	17.6
Co L α	776.2	8.87e+3	7.72	2.62e+0	16.0
Ni L α	851.5	6.97e+3	7.97	2.26e+0	14.6
Cu L α	929.7	5.59e+3	8.13	1.98e+0	13.3
Zn L α	1011.7	4.48e+3	8.24	1.72e+0	12.3
Na K α	1041.0	4.15e+3	8.26	1.64e+0	11.9
Ge L α	1188.0	2.92e+3	8.34	1.32e+0	10.4
Mg K α	1253.6	2.53e+3	8.36	1.21e+0	9.9
Al K α	1486.7	1.60e+3	8.37	9.02e-1	8.3
Si K α	1740.0	1.03e+3	8.35	6.84e-1	7.1
Zr L α	2042.4	6.61e+2	8.31	5.13e-1	6.1
Mo L α	2293.2	4.76e+2	8.28	4.15e-1	5.4
Cl K α	2622.4	3.25e+2	8.25	3.24e-1	4.7
Ag L α	2984.3	2.24e+2	8.22	2.54e-1	4.2
Ca K α	3691.7	1.20e+2	8.17	1.68e-1	3.4
Ti K α	4510.8	6.57e+1	8.13	1.13e-1	2.7
V K α	4952.2	4.94e+1	8.11	9.31e-2	2.5
Cr K α	5414.7	3.76e+1	8.10	7.75e-2	2.3
Mn K α	5898.8	2.89e+1	8.09	6.49e-2	2.1
Co K α	6930.3	1.76e+1	8.07	4.63e-2	1.8
Ni K α	7478.2	1.39e+1	8.06	3.94e-2	1.7
Cu K α	8047.8	1.10e+1	8.05	3.37e-2	1.5
Ge K α	9886.4	5.73e+0	8.04	2.16e-2	1.3
Y K α	14988.0	1.49e+0	8.02	8.48e-3	0.8
Mo K α	17479.0	9.02e-1	8.01	6.00e-3	0.7
Pd K α	21177.0	4.83e-1	8.01	3.89e-3	0.6
Sn K α	25271.0	2.72e-1	8.00	2.61e-3	0.5
Xe K α	29779.0	1.60e-1	8.00	1.81e-3	0.4

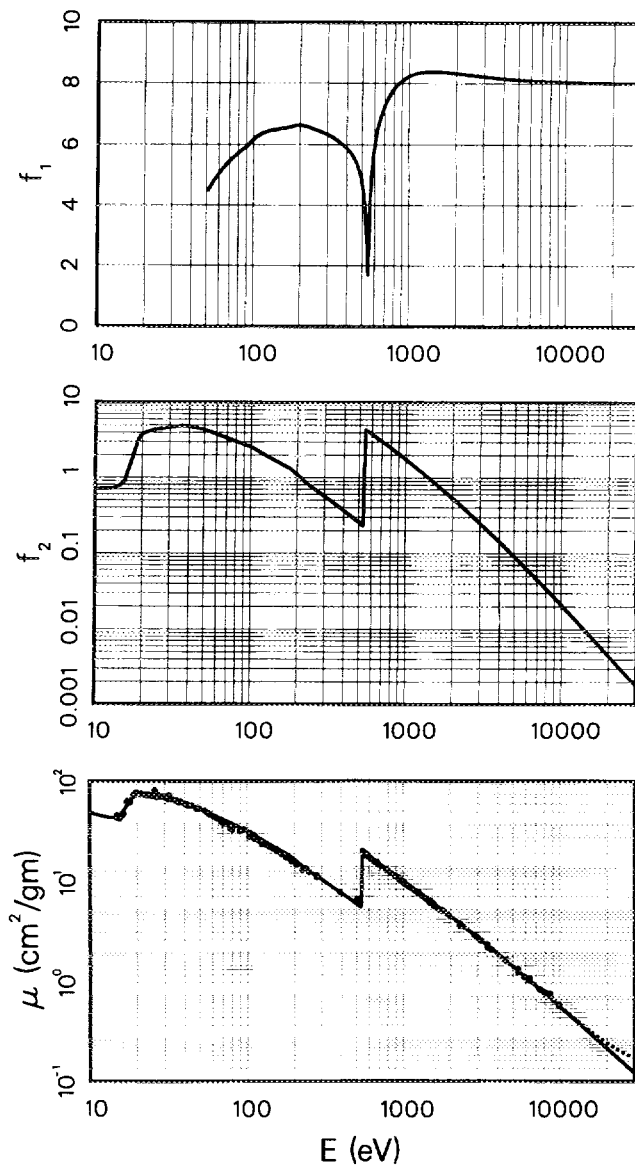

Edge Energies
 K 543.1 eV^a L_I 41.6 eV^a

References: 6, 9, 11, 13, 15, 18, 26, 80, 94, 95, 111, 143, 155, 176, 184, 190, 204, 207, 210, 212, 228.

TABLE I. Photoabsorption Cross Sections and Atomic Scattering Factors,
 $Z = 1-92$, $E = 50-30,000$ eV
 See page 211 for Explanation of Tables

μ_a (barns/atom) = μ (cm²/gm) \times 31.55
 E (keV) μ (cm²/gm) = $f_2 \times 2214.83$

Fluorine (F)
 $Z = 9$
 Atomic Weight = 18.998

Line	E(eV)	μ (cm ² /gm)	f_1	f_2	λ (Å)
H	10.2	1.25e + 4		5.76e - 2	1215
He I	21.2	3.41e + 5		3.27e + 0	584.3
Na L _{2,3}	30.5	3.61e + 5		4.96e + 0	407.2
Mg L _{2,3}	49.3	2.40e + 5		5.35e + 0	251.5
Al L _{2,3}	72.4	1.56e + 5	5.43	5.09e + 0	171.2
Si L _{2,3}	91.5	1.04e + 5	6.54	4.29e + 0	135.5
Be K	108.5	7.37e + 4	7.07	3.61e + 0	114.3
Sr M ζ	114.0	6.64e + 4	7.18	3.42e + 0	108.8
Y M ζ	132.8	4.82e + 4	7.44	2.89e + 0	93.4
Zr M ζ	151.1	3.62e + 4	7.58	2.47e + 0	82.1
B K α	183.3	2.33e + 4	7.68	1.93e + 0	67.6
Mo M ζ	192.6	2.08e + 4	7.70	1.81e + 0	64.4
Ar L ℓ	220.1	1.52e + 4	7.71	1.51e + 0	56.3
C K α	277.0	8.75e + 3	7.65	1.09e + 0	44.8
Ag M ζ	311.7	6.52e + 3	7.60	9.18e - 1	39.8
N K α	392.4	3.60e + 3	7.43	6.38e - 1	31.6
Ti L α	452.2	2.39e + 3	7.25	4.89e - 1	27.4
V L α	511.3	1.69e + 3	7.01	3.90e - 1	24.2
O K α	524.9	1.57e + 3	6.94	3.72e - 1	23.6
Cr L α	572.8	1.22e + 3	6.64	3.17e - 1	21.6
Mn L α	637.4	8.87e + 2	5.91	2.55e - 1	19.5
F K α	676.8	7.28e + 2	4.64	2.22e - 1	18.3
Fe L α	705.0	2.57e + 3	3.53	8.17e - 1	17.6
Co L α	776.2	1.05e + 4	7.00	3.67e + 0	16.0
Ni L α	851.5	8.42e + 3	7.92	3.24e + 0	14.6
Cu L α	929.7	6.81e + 3	8.44	2.86e + 0	13.3
Zn L α	1011.7	5.51e + 3	8.77	2.52e + 0	12.3
Na K α	1041.0	5.12e + 3	8.86	2.41e + 0	11.9
Ge L α	1188.0	3.65e + 3	9.13	1.96e + 0	10.4
Mg K α	1253.6	3.18e + 3	9.20	1.80e + 0	9.9
Al K α	1486.7	2.03e + 3	9.34	1.36e + 0	8.3
Si K α	1740.0	1.32e + 3	9.38	1.04e + 0	7.1
Zr L α	2042.4	8.49e + 2	9.37	7.83e - 1	6.1
Mo L α	2293.2	6.15e + 2	9.35	6.37e - 1	5.4
Cl K α	2622.4	4.22e + 2	9.31	5.00e - 1	4.7
Ag L α	2984.3	2.92e + 2	9.28	3.94e - 1	4.2
Ca K α	3691.7	1.58e + 2	9.22	2.64e - 1	3.4
Ti K α	4510.8	8.76e + 1	9.17	1.78e - 1	2.7
V K α	4952.2	6.63e + 1	9.15	1.48e - 1	2.5
Cr K α	5414.7	5.07e + 1	9.14	1.24e - 1	2.3
Mn K α	5898.8	3.91e + 1	9.12	1.04e - 1	2.1
Co K α	6930.3	2.40e + 1	9.09	7.50e - 2	1.8
Ni K α	7478.2	1.90e + 1	9.08	6.40e - 2	1.7
Cu K α	8047.8	1.51e + 1	9.07	5.50e - 2	1.5
Ge K α	9886.4	7.98e + 0	9.05	3.56e - 2	1.3
Y K α	14988.0	2.14e + 0	9.02	1.45e - 2	0.8
Mo K α	17479.0	1.31e + 0	9.02	1.03e - 2	0.7
Pd K α	21177.0	7.03e - 1	9.01	6.72e - 3	0.6
Sn K α	25271.0	3.98e - 1	9.01	4.54e - 3	0.5
Xe K α	29779.0	2.34e - 1	9.00	3.15e - 3	0.4

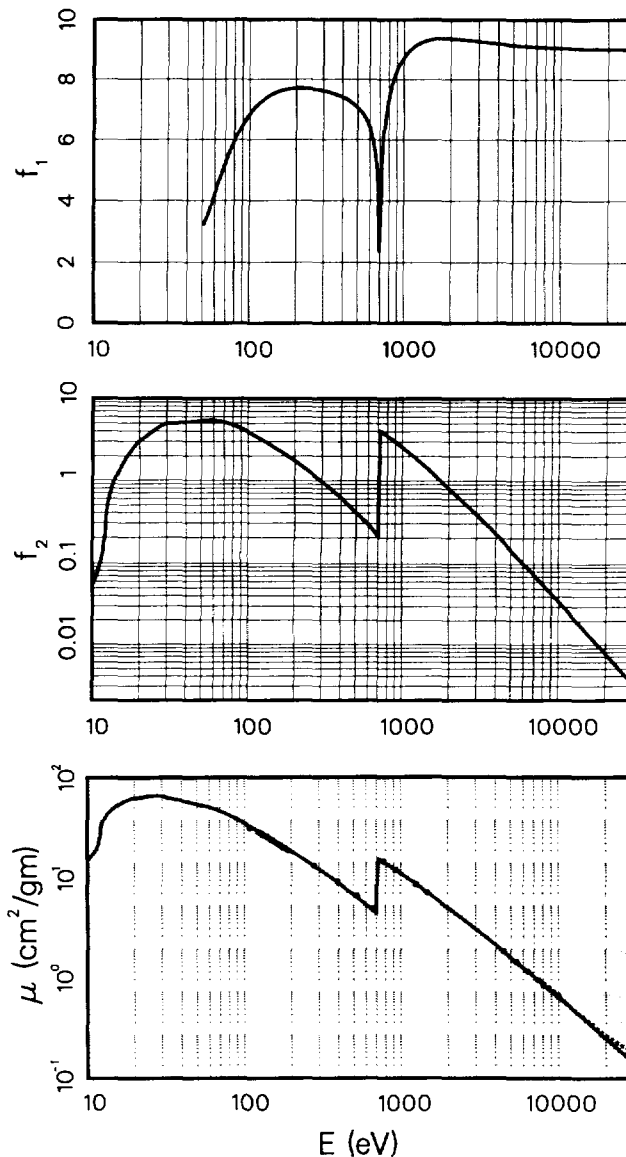

Edge Energies
 K 696.7 eV^a

References: 30, 80, 111, 172, 196, 207.

TABLE I. Photoabsorption Cross Sections and Atomic Scattering Factors,
 $Z = 1-92$, $E = 50-30,000$ eV
 See page 211 for Explanation of Tables

$\mu_a(\text{barns/atom}) = \mu(\text{cm}^2/\text{gm}) \times 33.51$
 $E(\text{keV})\mu(\text{cm}^2/\text{gm}) = f_2 \times 2085.18$

Neon (Ne)
 $Z = 10$
 Atomic Weight = 20.180

Line	E(eV)	$\mu(\text{cm}^2/\text{gm})$	f_1	f_2	$\lambda(\text{\AA})$
H	10.2				1215
He I	21.2				584.3
Na $L_{2,3}$	30.5	$2.61e+5$		$3.81e+0$	407.2
Mg $L_{2,3}$	49.3	$2.22e+5$		$5.25e+0$	251.5
Al $L_{2,3}$	72.4	$1.79e+5$	3.92	$6.20e+0$	171.2
Si $L_{2,3}$	91.5	$1.38e+5$	5.63	$6.04e+0$	135.5
Be K	108.5	$1.06e+5$	6.91	$5.53e+0$	114.3
Sr $M\zeta$	114.0	$9.66e+4$	7.20	$5.28e+0$	108.8
Y $M\zeta$	132.8	$7.11e+4$	7.85	$4.53e+0$	93.4
Zr $M\zeta$	151.1	$5.41e+4$	8.21	$3.92e+0$	82.1
B $K\alpha$	183.3	$3.54e+4$	8.61	$3.11e+0$	67.6
Mo $M\zeta$	192.6	$3.18e+4$	8.64	$2.93e+0$	64.4
Ar $L\ell$	220.1	$2.36e+4$	8.77	$2.49e+0$	56.3
C $K\alpha$	277.0	$1.36e+4$	8.82	$1.80e+0$	44.8
Ag $M\zeta$	311.7	$1.01e+4$	8.80	$1.50e+0$	39.8
N $K\alpha$	392.4	$5.60e+3$	8.68	$1.05e+0$	31.6
Ti $L\alpha$	452.2	$3.84e+3$	8.56	$8.33e-1$	27.4
V $L\alpha$	511.3	$2.77e+3$	8.42	$6.79e-1$	24.2
O $K\alpha$	524.9	$2.58e+3$	8.38	$6.50e-1$	23.6
Cr $L\alpha$	572.8	$2.04e+3$	8.25	$5.62e-1$	21.6
Mn $L\alpha$	637.4	$1.54e+3$	8.03	$4.70e-1$	19.5
F $K\alpha$	676.8	$1.30e+3$	7.85	$4.23e-1$	18.3
Fe $L\alpha$	705.0	$1.18e+3$	7.70	$3.98e-1$	17.6
Co $L\alpha$	776.2	$9.17e+2$	7.14	$3.41e-1$	16.0
Ni $L\alpha$	851.5	$7.15e+2$	4.92	$2.92e-1$	14.6
Cu $L\alpha$	929.7	$9.19e+3$	7.28	$4.10e+0$	13.3
Zn $L\alpha$	1011.7	$7.46e+3$	8.60	$3.62e+0$	12.3
Na $K\alpha$	1041.0	$6.93e+3$	8.87	$3.46e+0$	11.9
Ge $L\alpha$	1188.0	$4.93e+3$	9.64	$2.81e+0$	10.4
Mg $K\alpha$	1253.6	$4.29e+3$	9.83	$2.58e+0$	9.9
Al $K\alpha$	1486.7	$2.75e+3$	10.19	$1.96e+0$	8.3
Si $K\alpha$	1740.0	$1.81e+3$	10.34	$1.51e+0$	7.1
Zr $L\alpha$	2042.4	$1.17e+3$	10.39	$1.15e+0$	6.1
Mo $L\alpha$	2293.2	$8.52e+2$	10.40	$9.37e-1$	5.4
Cl $K\alpha$	2622.4	$5.87e+2$	10.38	$7.38e-1$	4.7
Ag $L\alpha$	2984.3	$4.08e+2$	10.35	$5.84e-1$	4.2
Ca $K\alpha$	3691.7	$2.23e+2$	10.29	$3.94e-1$	3.4
Ti $K\alpha$	4510.8	$1.25e+2$	10.23	$2.69e-1$	2.7
V $K\alpha$	4952.2	$9.46e+1$	10.21	$2.25e-1$	2.5
Cr $K\alpha$	5414.7	$7.26e+1$	10.18	$1.89e-1$	2.3
Mn $K\alpha$	5898.8	$5.63e+1$	10.16	$1.59e-1$	2.1
Co $K\alpha$	6930.3	$3.47e+1$	10.13	$1.15e-1$	1.8
Ni $K\alpha$	7478.2	$2.75e+1$	10.12	$9.88e-2$	1.7
Cu $K\alpha$	8047.8	$2.20e+1$	10.10	$8.50e-2$	1.5
Ge $K\alpha$	9886.4	$1.17e+1$	10.07	$5.56e-2$	1.3
Y $K\alpha$	14988.0	$3.21e+0$	10.04	$2.31e-2$	0.8
Mo $K\alpha$	17479.0	$1.97e+0$	10.03	$1.65e-2$	0.7
Pd $K\alpha$	21177.0	$1.07e+0$	10.02	$1.09e-2$	0.6
Sn $K\alpha$	25271.0	$6.07e-1$	10.01	$7.36e-3$	0.5
Xe $K\alpha$	29779.0	$3.59e-1$	10.01	$5.13e-3$	0.4

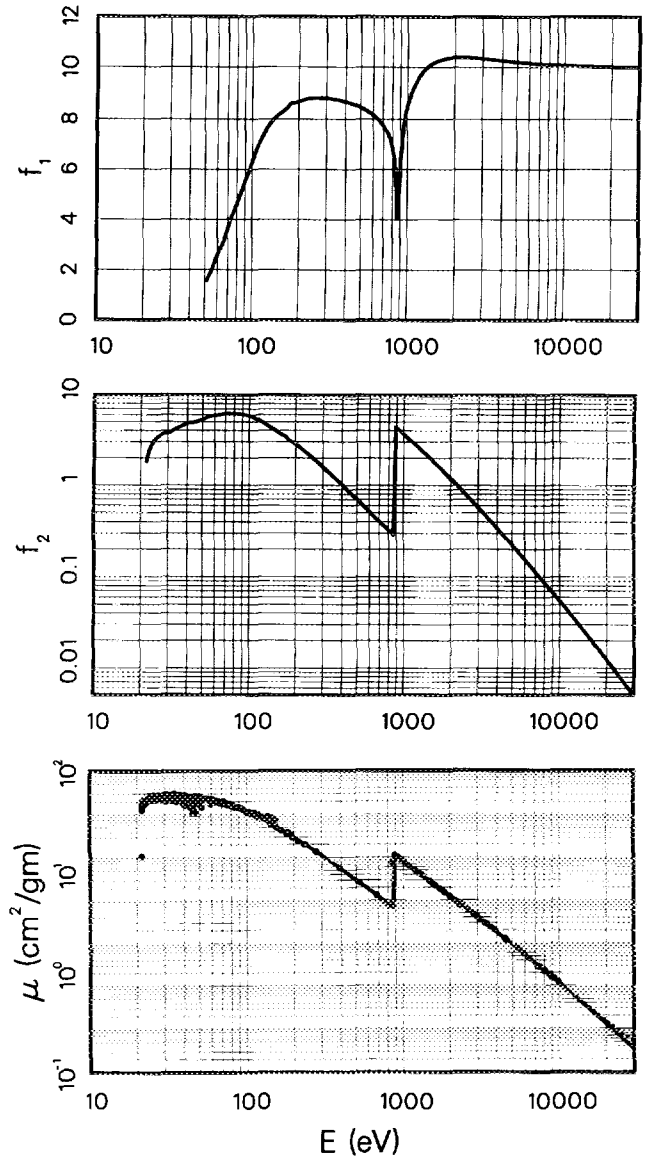

Edge Energies
 K 870.2 eV^a L_I 48.5 eV^a
 L_{II} 21.7 eV^a
 L_{III} 21.6 eV^a

References: 8, 9, 11, 34, 51, 75, 92, 95, 111, 140, 143, 151, 162, 176, 194, 218.

TABLE I. Photoabsorption Cross Sections and Atomic Scattering Factors,
 $Z = 1-92, E = 50-30,000 \text{ eV}$
 See page 211 for Explanation of Tables

$\mu_a(\text{barns/atom}) = \mu(\text{cm}^2/\text{gm}) \times 38.18$
 $E(\text{keV})\mu(\text{cm}^2/\text{gm}) = f_2 \times 1830.30$

Sodium (Na)
 $Z = 11$
 Atomic Weight = 22.990

Line	E(eV)	$\mu(\text{cm}^2/\text{gm})$	f_1	f_2	$\lambda (\text{\AA})$
H	10.2	2.74e+3		1.53e-2	1215
He I	21.2	3.02e+3		3.50e-2	584.3
Na L _{2,3}	30.5	4.52e+4		7.52e-1	407.2
Mg L _{2,3}	49.3	1.88e+5		5.05e+0	251.5
Al L _{2,3}	72.4	1.82e+5	2.34	7.22e+0	171.2
Si L _{2,3}	91.5	1.50e+5	4.73	7.52e+0	135.5
Be K	108.5	1.18e+5	6.42	7.02e+0	114.3
Sr M ζ	114.0	1.09e+5	6.79	6.79e+0	108.8
Y M ζ	132.8	8.43e+4	7.74	6.12e+0	93.4
Zr M ζ	151.1	6.73e+4	8.47	5.55e+0	82.1
B K α	183.3	4.54e+4	9.20	4.55e+0	67.6
Mo M ζ	192.6	4.11e+4	9.35	4.32e+0	64.4
Ar L ℓ	220.1	3.05e+4	9.67	3.67e+0	56.3
C K α	277.0	1.79e+4	9.93	2.71e+0	44.8
Ag M ζ	311.7	1.34e+4	9.96	2.27e+0	39.8
N K α	392.4	7.45e+3	9.91	1.60e+0	31.6
Ti L α	452.2	5.16e+3	9.82	1.27e+0	27.4
V L α	511.3	3.77e+3	9.71	1.05e+0	24.2
O K α	524.9	3.52e+3	9.69	1.01e+0	23.6
Cr L α	572.8	2.82e+3	9.60	8.81e-1	21.6
Mn L α	637.4	2.16e+3	9.47	7.51e-1	19.5
F K α	676.8	1.83e+3	9.39	6.75e-1	18.3
Fe L α	705.0	1.64e+3	9.32	6.33e-1	17.6
Co L α	776.2	1.27e+3	9.12	5.38e-1	16.0
Ni L α	851.5	9.84e+2	8.85	4.58e-1	14.6
Cu L α	929.7	7.74e+2	8.41	3.93e-1	13.3
Zn L α	1011.7	6.09e+2	7.47	3.36e-1	12.3
Na K α	1041.0	5.61e+2	6.59	3.19e-1	11.9
Ge L α	1188.0	5.97e+3	9.09	3.88e+0	10.4
Mg K α	1253.6	5.20e+3	9.73	3.56e+0	9.9
Al K α	1486.7	3.36e+3	10.74	2.73e+0	8.3
Si K α	1740.0	2.24e+3	11.14	2.13e+0	7.1
Zr L α	2042.4	1.46e+3	11.34	1.63e+0	6.1
Mo L α	2293.2	1.07e+3	11.40	1.34e+0	5.4
Cl K α	2622.4	7.35e+2	11.42	1.05e+0	4.7
Ag L α	2984.3	5.11e+2	11.41	8.33e-1	4.2
Ca K α	3691.7	2.78e+2	11.36	5.61e-1	3.4
Ti K α	4510.8	1.55e+2	11.29	3.83e-1	2.7
V K α	4952.2	1.18e+2	11.26	3.20e-1	2.5
Cr K α	5414.7	9.08e+1	11.24	2.69e-1	2.3
Mn K α	5898.8	7.04e+1	11.21	2.27e-1	2.1
Co K α	6930.3	4.36e+1	11.17	1.65e-1	1.8
Ni K α	7478.2	3.47e+1	11.15	1.42e-1	1.7
Cu K α	8047.8	2.78e+1	11.14	1.22e-1	1.5
Ge K α	9886.4	1.50e+1	11.10	8.08e-2	1.3
Y K α	14988.0	4.21e+0	11.05	3.45e-2	0.8
Mo K α	17479.0	2.61e+0	11.04	2.49e-2	0.7
Pd K α	21177.0	1.43e+0	11.02	1.65e-2	0.6
Sn K α	25271.0	8.19e-1	11.02	1.13e-2	0.5
Xe K α	29779.0	4.87e-1	11.01	7.92e-3	0.4

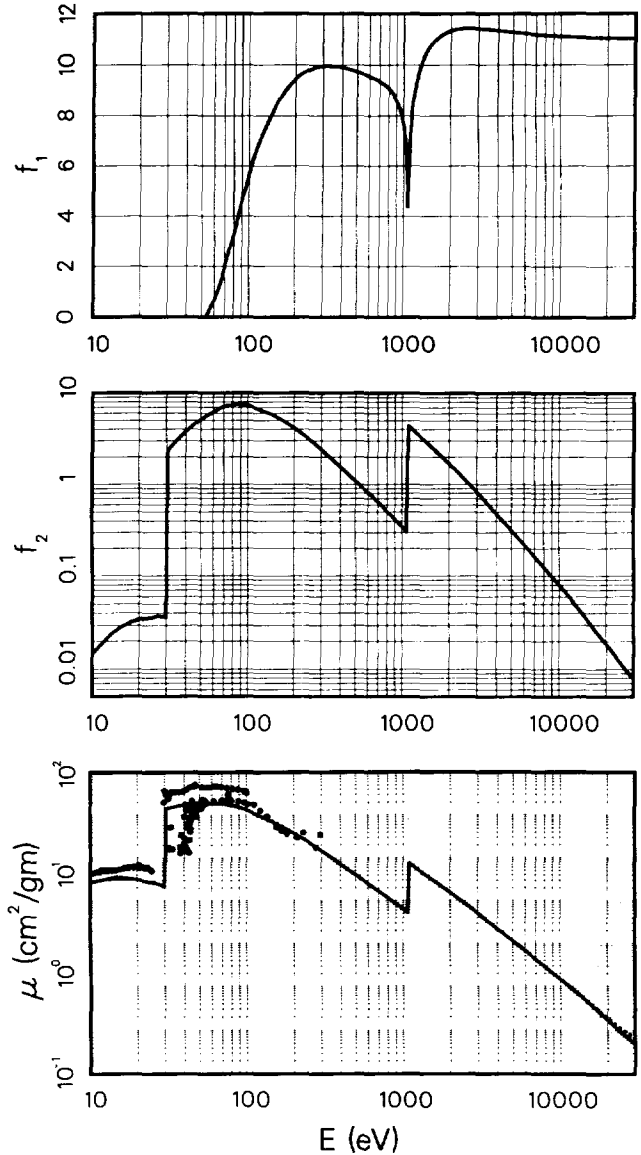

Edge Energies

K	1070.8 eV ^b	L _I	63.5 eV ^b
		L _{II}	30.6 eV ^a
		L _{III}	30.4 eV ^a

References: 112, 124, 127, 147, 163, 195.

TABLE I. Photoabsorption Cross Sections and Atomic Scattering Factors,
 $Z = 1-92$, $E = 50-30,000$ eV
 See page 211 for Explanation of Tables

$\mu_a(\text{barns/atom}) = \mu(\text{cm}^2/\text{gm}) \times 40.36$
 $E(\text{keV})\mu(\text{cm}^2/\text{gm}) = f_2 \times 1731.26$

Magnesium (Mg)
 $Z = 12$
 Atomic Weight = 24.305

Line	E(eV)	$\mu(\text{cm}^2/\text{gm})$	f_1	f_2	$\lambda(\text{\AA})$
H	10.2	6.89e + 3		4.06e - 2	1215
He I	21.2	1.21e + 4		1.48e - 1	584.3
Na L _{2,3}	30.5	1.15e + 4		2.02e - 1	407.2
Mg L _{2,3}	49.3	3.62e + 4		1.03e + 0	251.5
Al L _{2,3}	72.4	1.40e + 5	-0.64	5.84e + 0	171.2
Si L _{2,3}	91.5	1.49e + 5	2.21	7.86e + 0	135.5
Be K	108.5	1.29e + 5	4.26	8.09e + 0	114.3
Sr M ζ	114.0	1.22e + 5	4.81	8.07e + 0	108.8
Y M ζ	132.8	1.01e + 5	6.39	7.78e + 0	93.4
Zr M ζ	151.1	8.40e + 4	7.55	7.33e + 0	82.1
B K α	183.3	6.08e + 4	8.98	6.44e + 0	67.6
Mo M ζ	192.6	5.56e + 4	9.28	6.18e + 0	64.4
Ar L ℓ	220.1	4.29e + 4	9.97	5.45e + 0	56.3
C K α	277.0	2.61e + 4	10.73	4.18e + 0	44.8
Ag M ζ	311.7	1.98e + 4	10.95	3.57e + 0	39.8
N K α	392.4	1.13e + 4	11.11	2.55e + 0	31.6
Ti L α	452.2	7.81e + 3	11.10	2.04e + 0	27.4
V L α	511.3	5.65e + 3	11.04	1.67e + 0	24.2
O K α	524.9	5.27e + 3	11.02	1.60e + 0	23.6
Cr L α	572.8	4.17e + 3	10.95	1.38e + 0	21.6
Mn L α	637.4	3.12e + 3	10.85	1.15e + 0	19.5
F K α	676.8	2.65e + 3	10.78	1.04e + 0	18.3
Fe L α	705.0	2.37e + 3	10.73	9.65e - 1	17.6
Co L α	776.2	1.82e + 3	10.59	8.14e - 1	16.0
Ni L α	851.5	1.40e + 3	10.44	6.90e - 1	14.6
Cu L α	929.7	1.09e + 3	10.25	5.88e - 1	13.3
Zn L α	1011.7	8.80e + 2	10.01	5.14e - 1	12.3
Na K α	1041.0	8.14e + 2	9.91	4.90e - 1	11.9
Ge L α	1188.0	5.67e + 2	9.07	3.89e - 1	10.4
Mg K α	1253.6	4.89e + 2	8.10	3.54e - 1	9.9
Al K α	1486.7	4.28e + 3	10.45	3.68e + 0	8.3
Si K α	1740.0	2.90e + 3	11.59	2.92e + 0	7.1
Zr L α	2042.4	1.92e + 3	12.09	2.26e + 0	6.1
Mo L α	2293.2	1.41e + 3	12.28	1.87e + 0	5.4
Cl K α	2622.4	9.80e + 2	12.39	1.48e + 0	4.7
Ag L α	2984.3	6.86e + 2	12.43	1.18e + 0	4.2
Ca K α	3691.7	3.77e + 2	12.41	8.04e - 1	3.4
Ti K α	4510.8	2.12e + 2	12.36	5.53e - 1	2.7
V K α	4952.2	1.62e + 2	12.33	4.64e - 1	2.5
Cr K α	5414.7	1.25e + 2	12.30	3.91e - 1	2.3
Mn K α	5898.8	9.74e + 1	12.27	3.32e - 1	2.1
Co K α	6930.3	6.07e + 1	12.22	2.43e - 1	1.8
Ni K α	7478.2	4.85e + 1	12.20	2.09e - 1	1.7
Cu K α	8047.8	3.90e + 1	12.18	1.81e - 1	1.5
Ge K α	9886.4	2.10e + 1	12.14	1.20e - 1	1.3
Y K α	14988.0	5.82e + 0	12.07	5.04e - 2	0.8
Mo K α	17479.0	3.63e + 0	12.05	3.66e - 2	0.7
Pd K α	21177.0	2.00e + 0	12.03	2.45e - 2	0.6
Sn K α	25271.0	1.15e + 0	12.02	1.68e - 2	0.5
Xe K α	29779.0	6.88e - 1	12.01	1.18e - 2	0.4

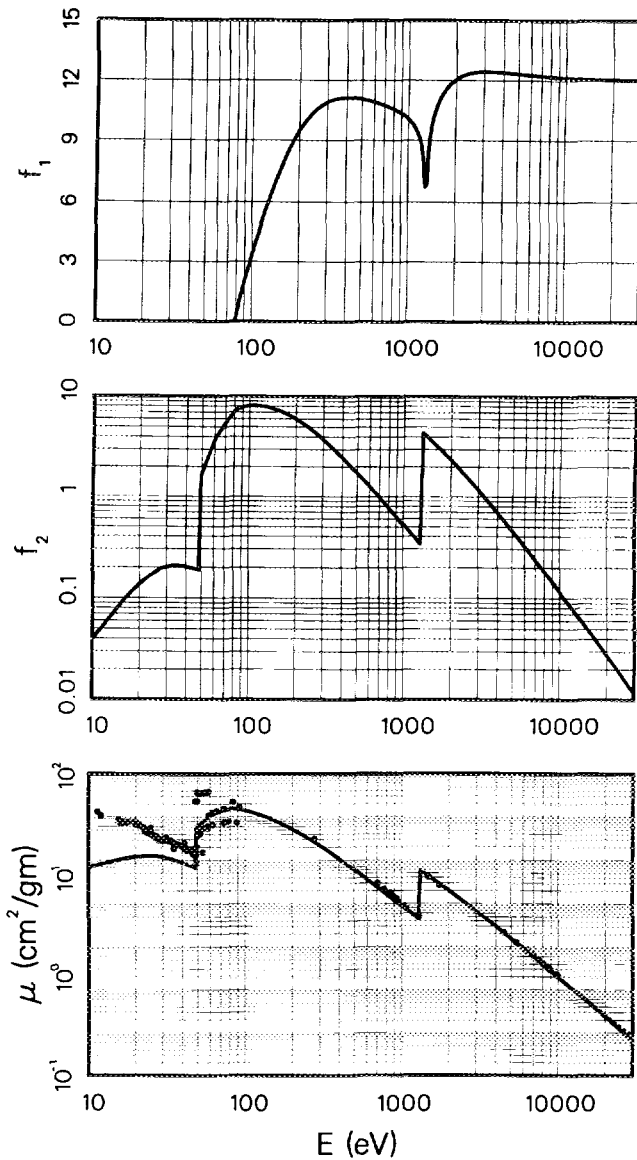

Edge Energies
 K 1303.0 eV^b L_I 88.6 eV^a
 L_{II} 49.6 eV^b
 L_{III} 49.2 eV^a

References: 2, 35, 41, 48, 67, 73, 76, 127, 147, 176, 185, 215.

TABLE I. Photoabsorption Cross Sections and Atomic Scattering Factors,
 $Z = 1-92$, $E = 50-30,000$ eV
 See page 211 for Explanation of Tables

Aluminum (Al)

$Z = 13$

Atomic Weight = 26.982

$\mu_a(\text{barns/atom}) = \mu(\text{cm}^2/\text{gm}) \times 44.80$
 $E(\text{keV})\mu(\text{cm}^2/\text{gm}) = f_2 \times 1559.52$

Line	E(eV)	$\mu(\text{cm}^2/\text{gm})$	f_1	f_2	$\lambda(\text{\AA})$
H	10.2	4.65e + 5		3.04	1215
He I	21.2	1.78e + 4		0.24	584.3
Na L _{2,3}	30.5	1.33e + 4		0.26	407.2
Mg L _{2,3}	49.3	1.10e + 4		0.35	251.5
Al L _{2,3}	72.4	1.04e + 4	-4.29	0.48	171.2
Si L _{2,3}	91.5	1.02e + 5	-0.57	5.99	135.5
Be K	108.5	1.12e + 5	0.83	7.80	114.3
Sr M ζ	114.0	1.14e + 5	1.35	8.37	108.8
Y M ζ	132.8	1.12e + 5	3.97	9.54	93.4
Zr M ζ	151.1	9.94e + 4	5.91	9.63	82.1
B K α	183.3	7.73e + 4	8.95	9.08	67.6
Mo M ζ	192.6	6.91e + 4	9.57	8.54	64.4
Ar L ℓ	220.1	5.11e + 4	10.58	7.22	56.3
C K α	277.0	3.19e + 4	11.75	5.66	44.8
Ag M ζ	311.7	2.37e + 4	12.08	4.73	39.8
N K α	392.4	1.36e + 4	12.22	3.41	31.6
Ti L α	452.2	9.75e + 3	12.29	2.83	27.4
V L α	511.3	7.18e + 3	12.29	2.35	24.2
O K α	524.9	6.71e + 3	12.28	2.26	23.6
Cr L α	572.8	5.36e + 3	12.25	1.97	21.6
Mn L α	637.4	4.03e + 3	12.19	1.65	19.5
F K α	676.8	3.41e + 3	12.13	1.48	18.3
Fe L α	705.0	3.08e + 3	12.09	1.39	17.6
Co L α	776.2	2.38e + 3	11.99	1.18	16.0
Ni L α	851.5	1.85e + 3	11.88	1.01	14.6
Cu L α	929.7	1.45e + 3	11.76	0.87	13.3
Zn L α	1011.7	1.15e + 3	11.62	0.75	12.3
Na K α	1041.0	1.07e + 3	11.57	0.71	11.9
Ge L α	1188.0	7.41e + 2	11.26	0.56	10.4
Mg K α	1253.6	6.39e + 2	11.08	0.51	9.9
Al K α	1486.7	4.03e + 2	9.60	0.38	8.3
Si K α	1740.0	3.21e + 3	11.32	3.59	7.1
Zr L α	2042.4	2.16e + 3	12.56	2.83	6.1
Mo L α	2293.2	1.60e + 3	12.97	2.36	5.4
Cl K α	2622.4	1.12e + 3	13.23	1.89	4.7
Ag L α	2984.3	7.92e + 2	13.35	1.52	4.2
Ca K α	3691.7	4.40e + 2	13.41	1.04	3.4
Ti K α	4510.8	2.50e + 2	13.38	0.72	2.7
V K α	4952.2	1.91e + 2	13.36	0.61	2.5
Cr K α	5414.7	1.48e + 2	13.33	0.51	2.3
Mn K α	5898.8	1.16e + 2	13.30	0.44	2.1
Co K α	6930.3	7.25e + 1	13.25	0.32	1.8
Ni K α	7478.2	5.80e + 1	13.23	0.28	1.7
Cu K α	8047.8	4.68e + 1	13.21	0.24	1.5
Ge K α	9886.4	2.56e + 1	13.16	0.16	1.3
Y K α	14988.0	7.45e + 0	13.08	0.07	0.8
Mo K α	17479.0	4.66e + 0	13.06	0.05	0.7
Pd K α	21177.0	2.58e + 0	13.04	0.04	0.6
Sn K α	25271.0	1.49e + 0	13.03	0.02	0.5
Xe K α	29779.0	8.91e - 1	13.02	0.02	0.4

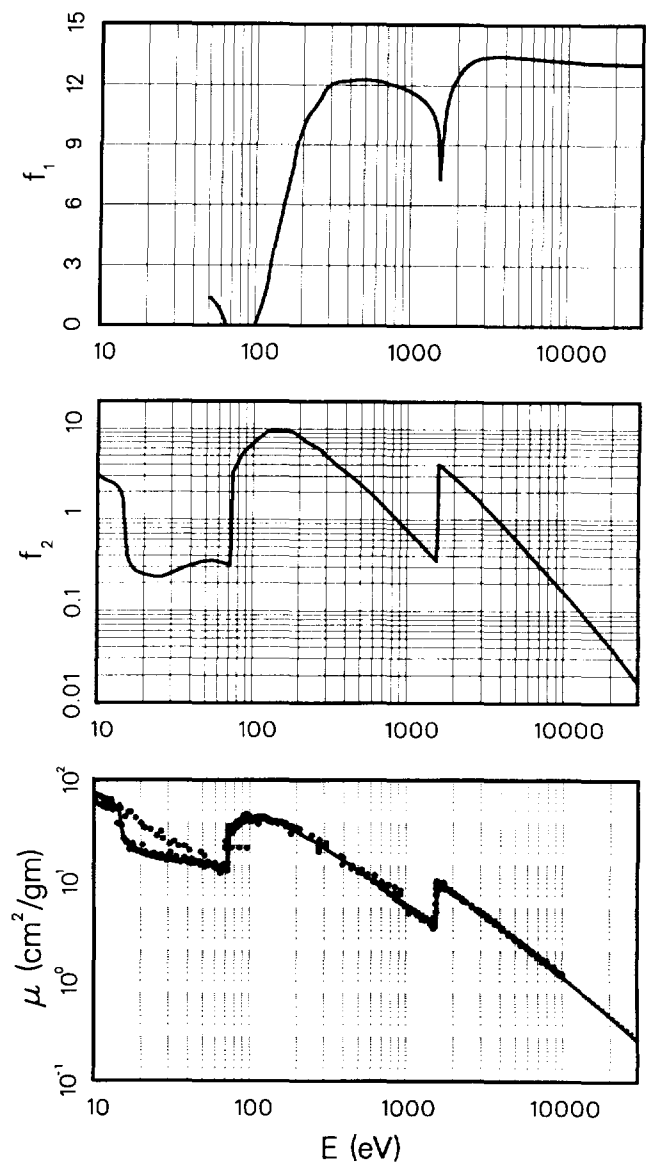

Edge Energies

K	1559.6 eV	L _I	117.8 eV ^a
		L _{II}	72.9 eV ^a
		L _{III}	72.5 eV ^a

References: 2, 3, 4, 5, 23, 27, 28, 32, 73, 79, 80, 95, 98, 99, 107, 108, 109, 114, 123, 127, 135, 146, 147, 149, 172, 177, 180, 185, 189, 192, 200, 216, 217, 223, 231, 232.

TABLE I. Photoabsorption Cross Sections and Atomic Scattering Factors,
 $Z = 1-92$, $E = 50-30,000$ eV
 See page 211 for Explanation of Tables

$$\mu_a(\text{barns/atom}) = \mu(\text{cm}^2/\text{gm}) \times 46.64$$

$$E(\text{keV})\mu(\text{cm}^2/\text{gm}) = f_2 \times 1498.22$$

Silicon (Si)
 $Z = 14$
 Atomic Weight = 28.086

Line	E(eV)	$\mu(\text{cm}^2/\text{gm})$	f_1	f_2	λ (Å)
H	10.2	4.49e+5		3.06	1215
He I	21.2	4.64e+4		0.66	584.3
Na L _{2,3}	30.5	1.77e+4		0.36	407.2
Mg L _{2,3}	49.3	1.52e+4		0.50	251.5
Al L _{2,3}	72.4	9.86e+3	2.58	0.48	171.2
Si L _{2,3}	91.5	7.12e+3	0.70	0.43	135.5
Be K	108.5	6.00e+4	-1.23	4.34	114.3
Sr M ζ	114.0	6.98e+4	-1.35	5.31	108.8
Y M ζ	132.8	1.07e+5	1.17	9.53	93.4
Zr M ζ	151.1	9.50e+4	4.08	9.58	82.1
B K α	183.3	8.61e+4	7.98	10.54	67.6
Mo M ζ	192.6	7.74e+4	8.92	9.95	64.4
Ar L ℓ	220.1	5.84e+4	10.51	8.58	56.3
C K α	277.0	3.59e+4	12.06	6.65	44.8
Ag M ζ	311.7	2.76e+4	12.62	5.74	39.8
N K α	392.4	1.60e+4	13.08	4.19	31.6
Ti L α	452.2	1.15e+4	13.19	3.48	27.4
V L α	511.3	8.66e+3	13.25	2.95	24.2
O K α	524.9	8.13e+3	13.27	2.85	23.6
Cr L α	572.8	6.52e+3	13.28	2.49	21.6
Mn L α	637.4	4.97e+3	13.25	2.12	19.5
F K α	676.8	4.27e+3	13.23	1.93	18.3
Fe L α	705.0	3.83e+3	13.20	1.80	17.6
Co L α	776.2	2.97e+3	13.13	1.54	16.0
Ni L α	851.5	2.33e+3	13.04	1.32	14.6
Cu L α	929.7	1.85e+3	12.95	1.15	13.3
Zn L α	1011.7	1.50e+3	12.83	1.01	12.3
Na K α	1041.0	1.40e+3	12.80	0.98	11.9
Ge L α	1188.0	9.91e+2	12.63	0.79	10.4
Mg K α	1253.6	8.59e+2	12.53	0.72	9.9
Al K α	1486.7	5.43e+2	12.09	0.54	8.3
Si K α	1740.0	3.51e+2	10.83	0.41	7.1
Zr L α	2042.4	2.63e+3	12.29	3.59	6.1
Mo L α	2293.2	1.98e+3	13.33	3.02	5.4
Cl K α	2622.4	1.40e+3	13.91	2.45	4.7
Ag L α	2984.3	9.93e+2	14.19	1.98	4.2
Ca K α	3691.7	5.57e+2	14.38	1.37	3.4
Ti K α	4510.8	3.19e+2	14.40	0.96	2.7
V K α	4952.2	2.45e+2	14.39	0.81	2.5
Cr K α	5414.7	1.90e+2	14.37	0.69	2.3
Mn K α	5898.8	1.49e+2	14.35	0.59	2.1
Co K α	6930.3	9.34e+1	14.30	0.43	1.8
Ni K α	7478.2	7.49e+1	14.28	0.37	1.7
Cu K α	8047.8	6.05e+1	14.25	0.32	1.5
Ge K α	9886.4	3.32e+1	14.19	0.22	1.3
Y K α	14988.0	9.69e+0	14.11	0.10	0.8
Mo K α	17479.0	6.09e+0	14.08	0.07	0.7
Pd K α	21177.0	3.39e+0	14.06	0.05	0.6
Sn K α	25271.0	1.96e+0	14.04	0.03	0.5
Xe K α	29779.0	1.18e+0	14.03	0.02	0.4

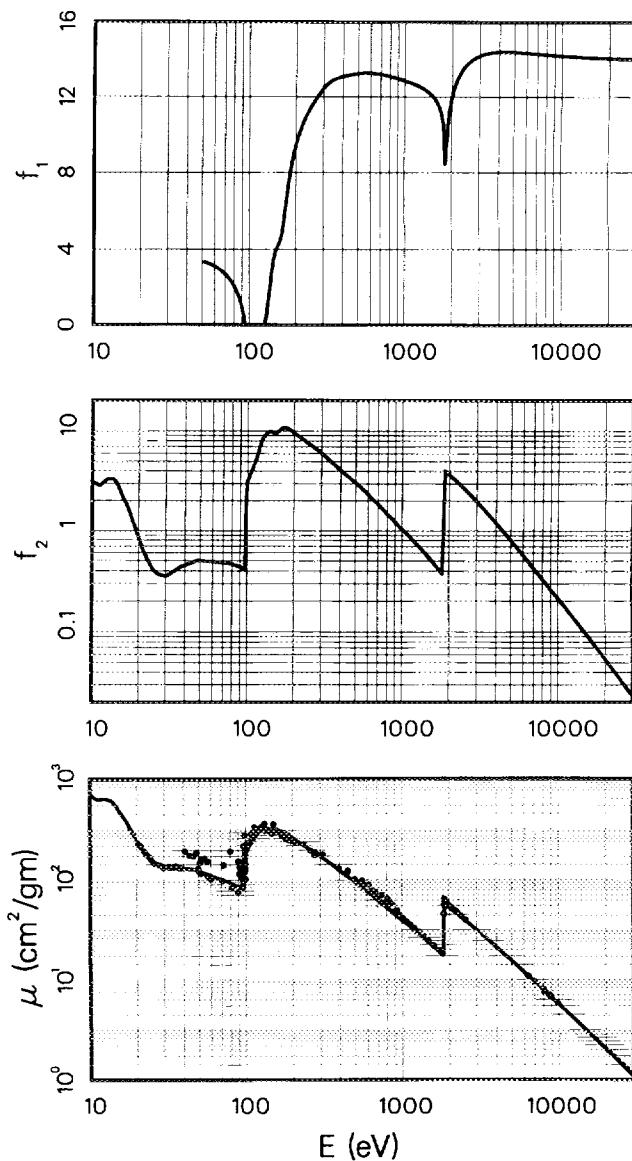

Edge Energies

K	1838.9 eV	L _I	149.7 eV ^a
		L _{II}	99.8 eV ^a
		L _{III}	99.2 eV ^a

References: 40, 77, 99, 127, 129, 146, 158, 167, 170, 176, 199, 226, 231, 233.

TABLE I. Photoabsorption Cross Sections and Atomic Scattering Factors,

 $Z = 1-92, E = 50-30,000 \text{ eV}$

See page 211 for Explanation of Tables

Phosphorus (P)

 $Z = 15$

Atomic Weight = 30.974

$$\mu_a(\text{barns/atom}) = \mu(\text{cm}^2/\text{gm}) \times 51.43$$

$$E(\text{keV})\mu(\text{cm}^2/\text{gm}) = f_2 \times 1358.51$$

Line	E(eV)	$\mu(\text{cm}^2/\text{gm})$	f_1	f_2	$\lambda(\text{\AA})$
H	10.2	1.10e+6		8.22	1215
He I	21.2	4.28e+4		0.67	584.3
Na L _{2,3}	30.5	1.12e+4		0.25	407.2
Mg L _{2,3}	49.3	1.60e+4		0.58	251.5
Al L _{2,3}	72.4	1.30e+4	4.17	0.69	171.2
Si L _{2,3}	91.5	1.00e+4	3.63	0.68	135.5
Be K	108.5	7.72e+3	2.69	0.62	114.3
Sr M ζ	114.0	7.05e+3	2.19	0.59	108.8
Y M ζ	132.8	5.16e+3	-3.56	0.50	93.4
Zr M ζ	151.1	7.68e+4	0.97	8.55	82.1
B K α	183.3	6.59e+4	4.57	8.89	67.6
Mo M ζ	192.6	7.33e+4	4.93	10.40	64.4
Ar L ℓ	220.1	6.15e+4	8.43	9.97	56.3
C K α	277.0	4.12e+4	11.12	8.40	44.8
Ag M ζ	311.7	3.26e+4	12.13	7.49	39.8
N K α	392.4	2.05e+4	13.39	5.93	31.6
Ti L α	452.2	1.50e+4	13.91	4.98	27.4
V L α	511.3	1.12e+4	14.18	4.22	24.2
O K α	524.9	1.05e+4	14.22	4.07	23.6
Cr L α	572.8	8.48e+3	14.33	3.58	21.6
Mn L α	637.4	6.51e+3	14.39	3.05	19.5
F K α	676.8	5.53e+3	14.40	2.76	18.3
Fe L α	705.0	5.00e+3	14.38	2.59	17.6
Co L α	776.2	3.90e+3	14.35	2.23	16.0
Ni L α	851.5	3.04e+3	14.30	1.91	14.6
Cu L α	929.7	2.40e+3	14.22	1.65	13.3
Zn L α	1011.7	1.92e+3	14.14	1.43	12.3
Na K α	1041.0	1.78e+3	14.10	1.36	11.9
Ge L α	1188.0	1.24e+3	13.94	1.08	10.4
Mg K α	1253.6	1.07e+3	13.86	0.99	9.9
Al K α	1486.7	6.75e+2	13.56	0.74	8.3
Si K α	1740.0	4.44e+2	13.12	0.57	7.1
Zr L α	2042.4	2.86e+2	11.75	0.43	6.1
Mo L α	2293.2	2.28e+3	12.64	3.84	5.4
Cl K α	2622.4	1.63e+3	14.24	3.14	4.7
Ag L α	2984.3	1.17e+3	14.85	2.56	4.2
Ca K α	3691.7	6.61e+2	15.28	1.80	3.4
Ti K α	4510.8	3.81e+2	15.40	1.27	2.7
V K α	4952.2	2.94e+2	15.41	1.07	2.5
Cr K α	5414.7	2.29e+2	15.41	0.91	2.3
Mn K α	5898.8	1.79e+2	15.39	0.78	2.1
Co K α	6930.3	1.13e+2	15.35	0.58	1.8
Ni K α	7478.2	9.10e+1	15.33	0.50	1.7
Cu K α	8047.8	7.37e+1	15.30	0.44	1.5
Ge K α	9886.4	4.04e+1	15.24	0.29	1.3
Y K α	14988.0	1.17e+1	15.13	0.13	0.8
Mo K α	17479.0	7.39e+0	15.10	0.10	0.7
Pd K α	21177.0	4.13e+0	15.07	0.06	0.6
Sn K α	25271.0	2.41e+0	15.05	0.04	0.5
Xe K α	29779.0	1.45e+0	15.04	0.03	0.4

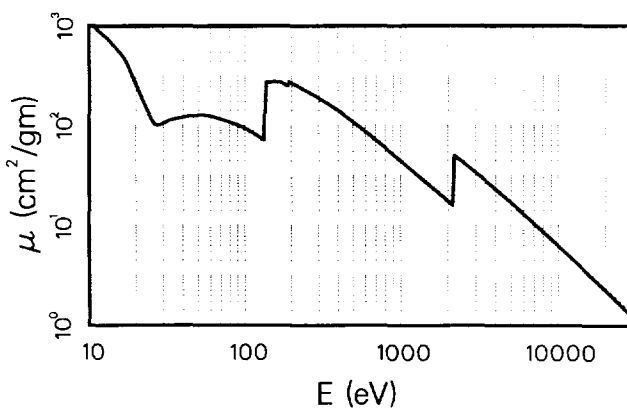
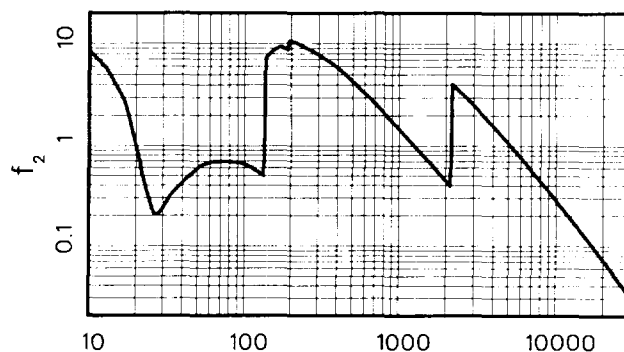
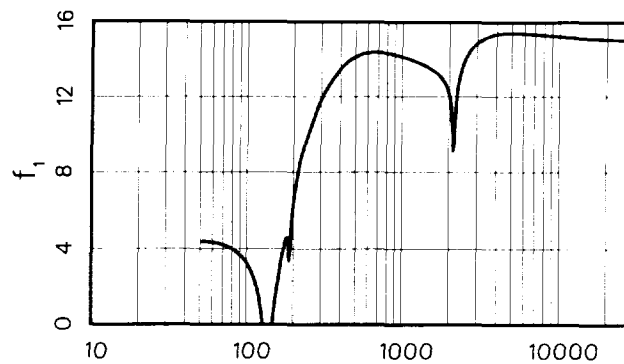

Edge Energies

K	2145.5 eV	L _I	189. eV ^a
		L _{II}	136. eV ^a
		L _{III}	135. eV ^a

TABLE I. Photoabsorption Cross Sections and Atomic Scattering Factors,
 $Z = 1-92$, $E = 50-30,000$ eV
 See page 211 for Explanation of Tables

Sulfur (S)
 $Z = 16$

Atomic Weight = 32.066

μ_a (barns/atom) = μ (cm²/gm) \times 53.25
 E (keV) μ (cm²/gm) = $f_2 \times 1312.24$

Line	E(eV)	μ (cm ² /gm)	f_1	f_2	λ (Å)
H	10.2	5.50e + 5		4.28	1215
He I	21.2	4.39e + 5		7.10	584.3
Na L _{2,3}	30.5	7.66e + 4		1.78	407.2
Mg L _{2,3}	49.3	1.48e + 4		0.56	251.5
Al L _{2,3}	72.4	2.02e + 4	4.91	1.11	171.2
Si L _{2,3}	91.5	1.62e + 4	4.71	1.13	135.5
Be K	108.5	1.28e + 4	4.29	1.06	114.3
Sr M ζ	114.0	1.20e + 4	4.08	1.04	108.8
Y M ζ	132.8	9.63e + 3	2.97	0.97	93.4
Zr M ζ	151.1	7.92e + 3	0.38	0.91	82.1
B K α	183.3	7.41e + 4	3.00	10.35	67.6
Mo M ζ	192.6	6.97e + 4	4.34	10.23	64.4
Ar L ℓ	220.1	5.91e + 4	6.55	9.92	56.3
C K α	277.0	4.76e + 4	10.01	10.04	44.8
Ag M ζ	311.7	3.84e + 4	11.72	9.12	39.8
N K α	392.4	2.49e + 4	13.70	7.44	31.6
Ti L α	452.2	1.83e + 4	14.54	6.31	27.4
V L α	511.3	1.38e + 4	14.99	5.38	24.2
O K α	524.9	1.30e + 4	15.06	5.20	23.6
Cr L α	572.8	1.06e + 4	15.27	4.63	21.6
Mn L α	637.4	8.18e + 3	15.44	3.97	19.5
F K α	676.8	7.01e + 3	15.48	3.62	18.3
Fe L α	705.0	6.36e + 3	15.50	3.42	17.6
Co L α	776.2	4.95e + 3	15.53	2.93	16.0
Ni L α	851.5	3.89e + 3	15.50	2.52	14.6
Cu L α	929.7	3.08e + 3	15.45	2.18	13.3
Zn L α	1011.7	2.46e + 3	15.38	1.89	12.3
Na K α	1041.0	2.28e + 3	15.36	1.81	11.9
Ge L α	1188.0	1.59e + 3	15.22	1.44	10.4
Mg K α	1253.6	1.38e + 3	15.15	1.32	9.9
Al K α	1486.7	8.70e + 2	14.91	0.99	8.3
Si K α	1740.0	5.74e + 2	14.62	0.76	7.1
Zr L α	2042.4	3.71e + 2	14.14	0.58	6.1
Mo L α	2293.2	2.67e + 2	13.30	0.47	5.4
Cl K α	2622.4	1.89e + 3	13.63	3.77	4.7
Ag L α	2984.3	1.37e + 3	15.22	3.11	4.2
Ca K α	3691.7	7.83e + 2	16.07	2.20	3.4
Ti K α	4510.8	4.56e + 2	16.34	1.57	2.7
V K α	4952.2	3.53e + 2	16.38	1.33	2.5
Cr K α	5414.7	2.75e + 2	16.40	1.14	2.3
Mn K α	5898.8	2.17e + 2	16.40	0.97	2.1
Co K α	6930.3	1.37e + 2	16.37	0.73	1.8
Ni K α	7478.2	1.11e + 2	16.35	0.63	1.7
Cu K α	8047.8	8.98e + 1	16.33	0.55	1.5
Ge K α	9886.4	4.97e + 1	16.27	0.37	1.3
Y K α	14988.0	1.48e + 1	16.16	0.17	0.8
Mo K α	17479.0	9.35e + 0	16.12	0.12	0.7
Pd K α	21177.0	5.24e + 0	16.09	0.08	0.6
Sn K α	25271.0	3.06e + 0	16.06	0.06	0.5
Xe K α	29779.0	1.85e + 0	16.04	0.04	0.4

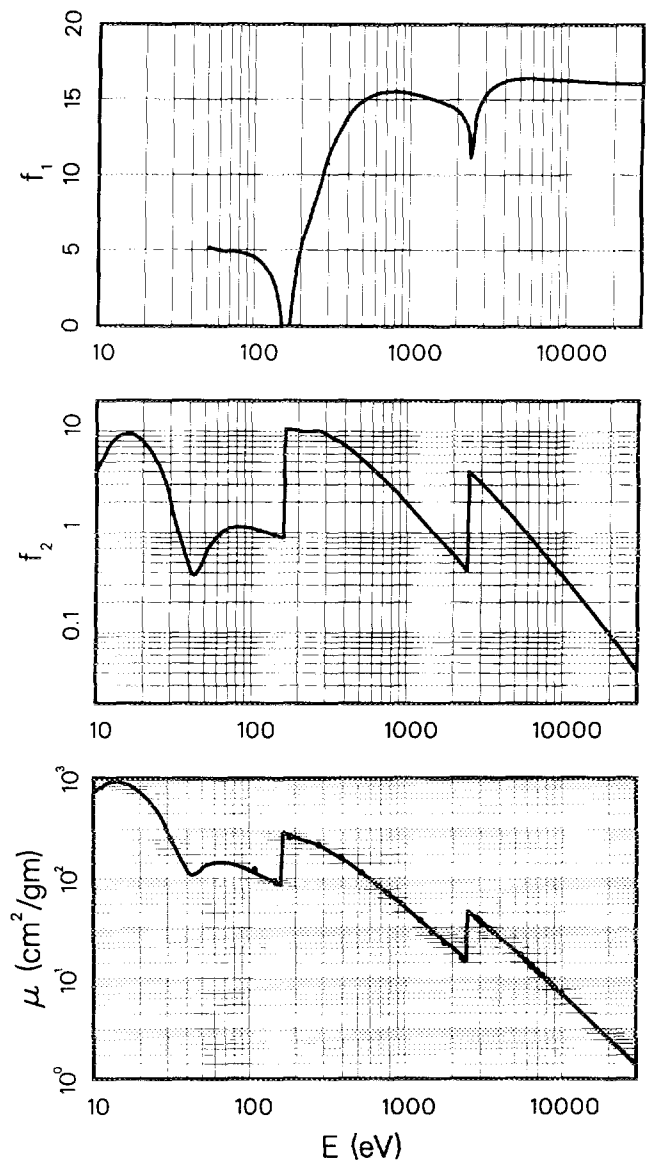

Edge Energies

K	2472.0 eV	L _I	230.9 eV ^a
		L _{II}	163.6 eV ^a
		L _{III}	162.5 eV ^a

References: 8, 9, 29, 111, 176, 216.

TABLE I. Photoabsorption Cross Sections and Atomic Scattering Factors,

$Z = 1-92, E = 50-30,000 \text{ eV}$

See page 211 for Explanation of Tables

$\mu_a(\text{barns/atom}) = \mu(\text{cm}^2/\text{gm}) \times 58.87$
 $E(\text{keV})\mu(\text{cm}^2/\text{gm}) = f_2 \times 1186.88$

Chlorine (Cl)
 $Z = 17$
 Atomic Weight = 35.453

Line	E(eV)	$\mu(\text{cm}^2/\text{gm})$	f_1	f_2	$\lambda(\text{\AA})$
H	10.2	2.03e + 5		1.75	1215
He I	21.2	5.46e + 5		9.76	584.3
Na L _{2,3}	30.5	1.72e + 5		4.40	407.2
Mg L _{2,3}	49.3	1.32e + 4		0.55	251.5
Al L _{2,3}	72.4	2.19e + 4	5.64	1.34	171.2
Si L _{2,3}	91.5	1.92e + 4	5.67	1.48	135.5
Be K	108.5	1.62e + 4	5.58	1.48	114.3
Sr M ζ	114.0	1.52e + 4	5.51	1.46	108.8
Y M ζ	132.8	1.24e + 4	5.13	1.39	93.4
Zr M ζ	151.1	1.04e + 4	4.48	1.32	82.1
B K α	183.3	7.54e + 3	1.59	1.16	67.6
Mo M ζ	192.6	6.94e + 3	-0.98	1.13	64.4
Ar L ℓ	220.1	6.20e + 4	2.39	11.50	56.3
C K α	277.0	5.04e + 4	8.71	11.77	44.8
Ag M ζ	311.7	4.14e + 4	11.05	10.87	39.8
N K α	392.4	2.76e + 4	14.04	9.11	31.6
Ti L α	452.2	2.01e + 4	15.27	7.64	27.4
V L α	511.3	1.50e + 4	15.89	6.48	24.2
O K α	524.9	1.41e + 4	15.99	6.24	23.6
Cr L α	572.8	1.14e + 4	16.24	5.52	21.6
Mn L α	637.4	8.81e + 3	16.44	4.73	19.5
F K α	676.8	7.59e + 3	16.50	4.33	18.3
Fe L α	705.0	6.86e + 3	16.54	4.07	17.6
Co L α	776.2	5.39e + 3	16.57	3.52	16.0
Ni L α	851.5	4.26e + 3	16.57	3.06	14.6
Cu L α	929.7	3.40e + 3	16.54	2.66	13.3
Zn L α	1011.7	2.73e + 3	16.49	2.33	12.3
Na K α	1041.0	2.54e + 3	16.47	2.23	11.9
Ge L α	1188.0	1.80e + 3	16.35	1.80	10.4
Mg K α	1253.6	1.56e + 3	16.30	1.65	9.9
Al K α	1486.7	9.93e + 2	16.10	1.24	8.3
Si K α	1740.0	6.58e + 2	15.88	0.97	7.1
Zr L α	2042.4	4.27e + 2	15.58	0.73	6.1
Mo L α	2293.2	3.11e + 2	15.23	0.60	5.4
Cl K α	2622.4	2.15e + 2	14.31	0.48	4.7
Ag L α	2984.3	1.51e + 3	14.55	3.79	4.2
Ca K α	3691.7	8.77e + 2	16.67	2.73	3.4
Ti K α	4510.8	5.15e + 2	17.20	1.96	2.7
V K α	4952.2	3.99e + 2	17.31	1.67	2.5
Cr K α	5414.7	3.13e + 2	17.37	1.43	2.3
Mn K α	5898.8	2.47e + 2	17.39	1.23	2.1
Co K α	6930.3	1.57e + 2	17.40	0.92	1.8
Ni K α	7478.2	1.27e + 2	17.38	0.80	1.7
Cu K α	8047.8	1.03e + 2	17.37	0.70	1.5
Ge K α	9886.4	5.72e + 1	17.31	0.48	1.3
Y K α	14988.0	1.71e + 1	17.19	0.22	0.8
Mo K α	17479.0	1.08e + 1	17.15	0.16	0.7
Pd K α	21177.0	6.11e + 0	17.11	0.11	0.6
Sn K α	25271.0	3.58e + 0	17.08	0.08	0.5
Xe K α	29779.0	2.17e + 0	17.06	0.05	0.4

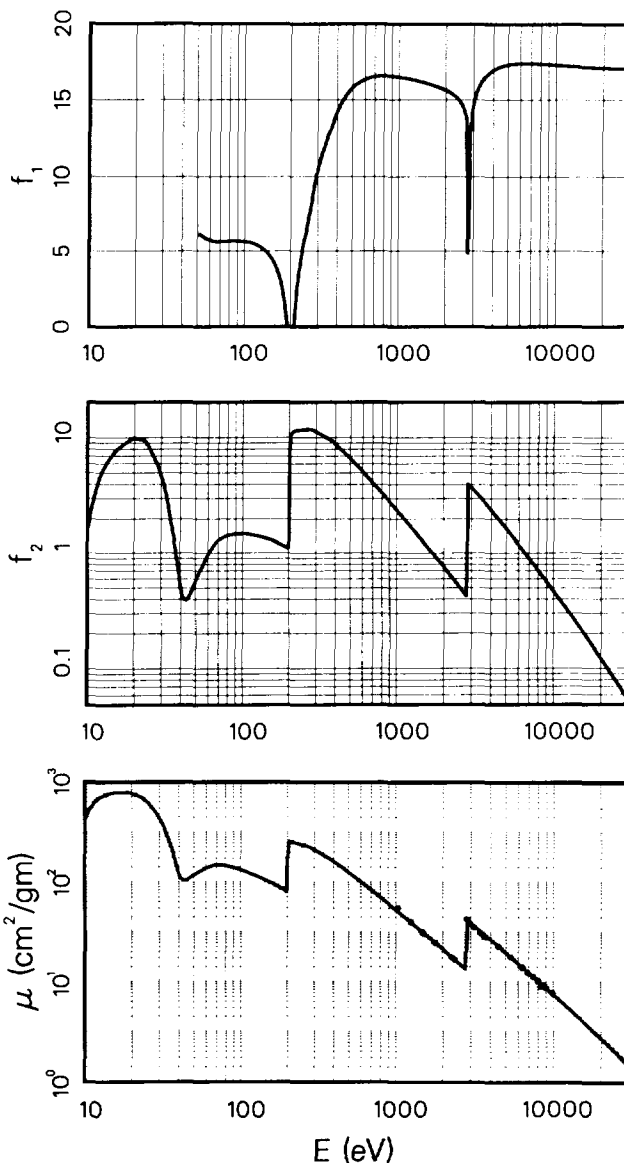

Edge Energies

K	2822.4 eV	L _I	270.2 eV
		L _{II}	201.6 eV
		L _{III}	200.0 eV

References: 8, 29, 111, 176.

TABLE I. Photoabsorption Cross Sections and Atomic Scattering Factors,
 $Z = 1-92$, $E = 50-30,000$ eV
 See page 211 for Explanation of Tables

$\mu_a(\text{barns/atom}) = \mu(\text{cm}^2/\text{gm}) \times 66.34$
 $E(\text{keV})\mu(\text{cm}^2/\text{gm}) = f_2 \times 1053.32$

Argon (Ar)
 $Z = 18$
 Atomic Weight = 39.948

Line	E(eV)	$\mu(\text{cm}^2/\text{gm})$	f_1	f_2	$\lambda(\text{\AA})$
H	10.2				1215
He I	21.2	5.59e+5		11.26	584.3
Na L _{2,3}	30.5	3.95e+5		11.41	407.2
Mg L _{2,3}	49.3	1.35e+4		0.63	251.5
Al L _{2,3}	72.4	2.13e+4	6.14	1.47	171.2
Si L _{2,3}	91.5	2.09e+4	6.12	1.82	135.5
Be K	108.5	1.84e+4	6.19	1.90	114.3
Sr M ζ	114.0	1.76e+4	6.20	1.91	108.8
Y M ζ	132.8	1.40e+4	6.15	1.77	93.4
Zr M ζ	151.1	1.16e+4	5.84	1.67	82.1
B K α	183.3	8.80e+3	4.91	1.53	67.6
Mo M ζ	192.6	8.06e+3	4.48	1.47	64.4
Ar L ℓ	220.1	6.00e+3	2.08	1.25	56.3
C K α	277.0	5.62e+4	5.48	14.79	44.8
Ag M ζ	311.7	4.09e+4	8.88	12.11	39.8
N K α	392.4	2.96e+4	13.68	11.03	31.6
Ti L α	452.2	2.18e+4	15.02	9.34	27.4
V L α	511.3	1.70e+4	15.93	8.25	24.2
O K α	524.9	1.61e+4	16.11	8.03	23.6
Cr L α	572.8	1.33e+4	16.68	7.22	21.6
Mn L α	637.4	1.04e+4	17.13	6.26	19.5
F K α	676.8	8.93e+3	17.29	5.74	18.3
Fe L α	705.0	8.14e+3	17.38	5.45	17.6
Co L α	776.2	6.45e+3	17.58	4.75	16.0
Ni L α	851.5	5.07e+3	17.67	4.10	14.6
Cu L α	929.7	4.05e+3	17.68	3.57	13.3
Zn L α	1011.7	3.25e+3	17.67	3.12	12.3
Na K α	1041.0	3.01e+3	17.65	2.98	11.9
Ge L α	1188.0	2.12e+3	17.56	2.39	10.4
Mg K α	1253.6	1.84e+3	17.51	2.19	9.9
Al K α	1486.7	1.16e+3	17.31	1.64	8.3
Si K α	1740.0	7.68e+2	17.09	1.27	7.1
Zr L α	2042.4	5.03e+2	16.84	0.98	6.1
Mo L α	2293.2	3.69e+2	16.61	0.80	5.4
Cl K α	2622.4	2.56e+2	16.19	0.64	4.7
Ag L α	2984.3	1.78e+2	15.24	0.51	4.2
Ca K α	3691.7	9.78e+2	16.85	3.43	3.4
Ti K α	4510.8	5.80e+2	17.95	2.48	2.7
V K α	4952.2	4.51e+2	18.16	2.12	2.5
Cr K α	5414.7	3.54e+2	18.29	1.82	2.3
Mn K α	5898.8	2.80e+2	18.36	1.57	2.1
Co K α	6930.3	1.79e+2	18.41	1.18	1.8
Ni K α	7478.2	1.45e+2	18.41	1.03	1.7
Cu K α	8047.8	1.18e+2	18.41	0.90	1.5
Ge K α	9886.4	6.58e+1	18.36	0.62	1.3
Y K α	14988.0	1.98e+1	18.22	0.28	0.8
Mo K α	17479.0	1.26e+1	18.18	0.21	0.7
Pd K α	21177.0	7.11e+0	18.13	0.14	0.6
Sn K α	25271.0	4.18e+0	18.10	0.10	0.5
Xe K α	29779.0	2.54e+0	18.07	0.07	0.4

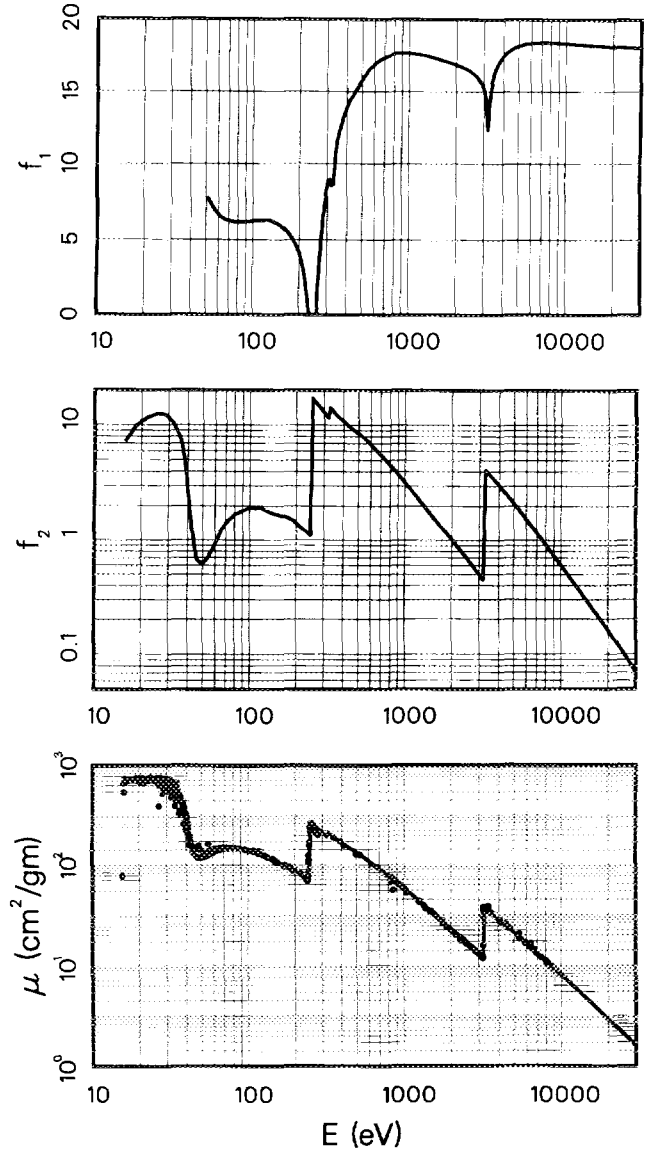

Edge Energies

K	3205.9 eV ^a	L _I	326.3 eV ^a	M _I	29.3 eV ^a
		L _{II}	250.6 eV ^a	M _{II}	15.9 eV ^a
		L _{III}	248.4 eV ^a	M _{III}	15.8 eV ^a

References: 8, 9, 11, 13, 15, 38, 62, 65, 68, 70, 81, 83, 95, 111, 132, 140, 143, 151, 153, 161, 162, 164, 176, 187, 194.

TABLE I. Photoabsorption Cross Sections and Atomic Scattering Factors,
 $Z = 1-92$, $E = 50-30,000$ eV
 See page 211 for Explanation of Tables

$\mu_a(\text{barns/atom}) = \mu(\text{cm}^2/\text{gm}) \times 64.93$
 $E(\text{keV})\mu(\text{cm}^2/\text{gm}) = f_2 \times 1076.22$

Potassium (K)
 $Z = 19$
 Atomic Weight = 39.098

Line	E(eV)	$\mu(\text{cm}^2/\text{gm})$	f_1	f_2	$\lambda(\text{\AA})$
H	10.2	3.75e + 3		0.04	1215
He I	21.2	3.29e + 5		6.48	584.3
Na L _{2,3}	30.5	5.56e + 5		15.73	407.2
Mg L _{2,3}	49.3	3.11e + 4		1.42	251.5
Al L _{2,3}	72.4	1.97e + 4	7.36	1.33	171.2
Si L _{2,3}	91.5	2.40e + 4	7.33	2.04	135.5
Be K	108.5	2.11e + 4	7.46	2.13	114.3
Sr M ζ	114.0	2.02e + 4	7.48	2.14	108.8
Y M ζ	132.8	1.74e + 4	7.56	2.14	93.4
Zr M ζ	151.1	1.49e + 4	7.52	2.09	82.1
B K α	183.3	1.14e + 4	7.24	1.94	67.6
Mo M ζ	192.6	1.06e + 4	7.09	1.89	64.4
Ar L l	220.1	8.52e + 3	6.37	1.74	56.3
C K α	277.0	5.73e + 3	1.24	1.48	44.8
Ag M ζ	311.7	5.02e + 4	3.13	14.54	39.8
N K α	392.4	3.54e + 4	11.38	12.90	31.6
Ti L α	452.2	2.70e + 4	14.47	11.35	27.4
V L α	511.3	2.05e + 4	16.14	9.75	24.2
O K α	524.9	1.93e + 4	16.40	9.43	23.6
Cr L α	572.8	1.58e + 4	17.11	8.40	21.6
Mn L α	637.4	1.23e + 4	17.71	7.29	19.5
F K α	676.8	1.07e + 4	17.97	6.73	18.3
Fe L α	705.0	9.68e + 3	18.14	6.34	17.6
Co L α	776.2	7.55e + 3	18.37	5.45	16.0
Ni L α	851.5	5.95e + 3	18.42	4.71	14.6
Cu L α	929.7	4.91e + 3	18.41	4.24	13.3
Zn L α	1011.7	4.04e + 3	18.52	3.80	12.3
Na K α	1041.0	3.76e + 3	18.53	3.64	11.9
Ge L α	1188.0	2.70e + 3	18.54	2.98	10.4
Mg K α	1253.6	2.35e + 3	18.53	2.74	9.9
Al K α	1486.7	1.51e + 3	18.41	2.08	8.3
Si K α	1740.0	9.96e + 2	18.25	1.61	7.1
Zr L α	2042.4	6.46e + 2	18.04	1.23	6.1
Mo L α	2293.2	4.72e + 2	17.86	1.01	5.4
Cl K α	2622.4	3.27e + 2	17.57	0.80	4.7
Ag L α	2984.3	2.29e + 2	17.13	0.64	4.2
Ca K α	3691.7	1.24e + 3	15.02	4.24	3.4
Ti K α	4510.8	7.18e + 2	18.52	3.01	2.7
V K α	4952.2	5.58e + 2	18.91	2.57	2.5
Cr K α	5414.7	4.38e + 2	19.13	2.21	2.3
Mn K α	5898.8	3.47e + 2	19.26	1.90	2.1
Co K α	6930.3	2.24e + 2	19.38	1.44	1.8
Ni K α	7478.2	1.82e + 2	19.41	1.27	1.7
Cu K α	8047.8	1.48e + 2	19.42	1.10	1.5
Ge K α	9886.4	8.30e + 1	19.37	0.76	1.3
Y K α	14988.0	2.54e + 1	19.26	0.35	0.8
Mo K α	17479.0	1.62e + 1	19.21	0.26	0.7
Pd K α	21177.0	9.20e + 0	19.16	0.18	0.6
Sn K α	25271.0	5.41e + 0	19.12	0.13	0.5
Xe K α	29779.0	3.30e + 0	19.09	0.09	0.4

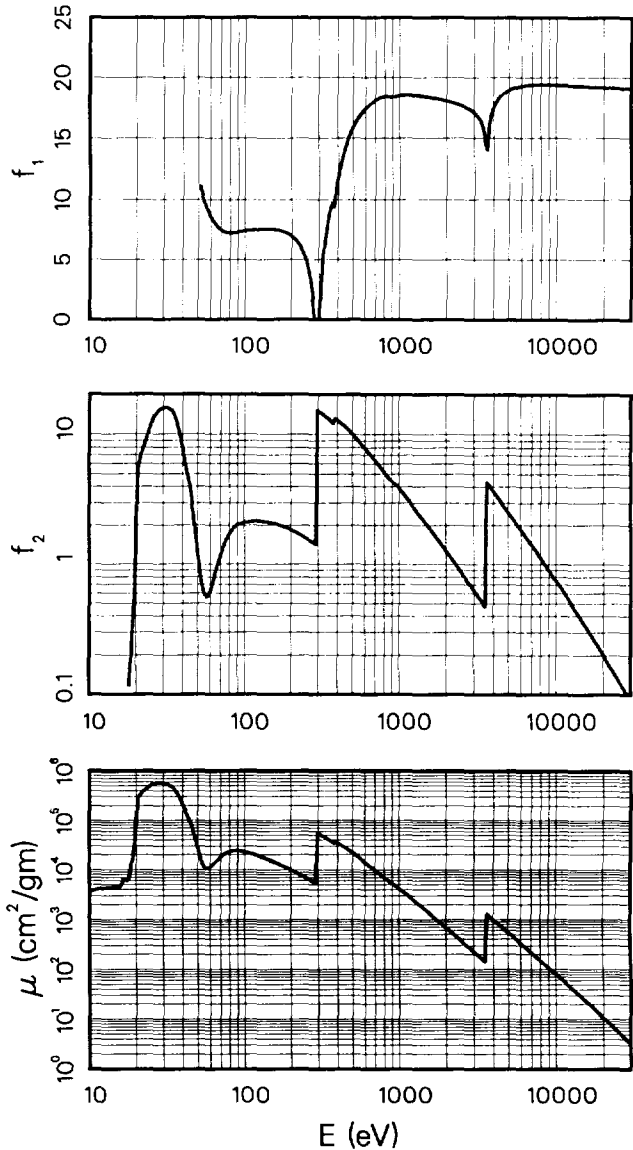

Edge Energies

K	3608.4 eV ^a	L _I	378.6 eV ^a	M _I	34.8 eV ^a
		L _{II}	297.3 eV ^a	M _{II}	18.3 eV ^a
		L _{III}	294.6 eV ^a	M _{III}	18.3 eV ^a

TABLE I. Photoabsorption Cross Sections and Atomic Scattering Factors,
 $Z = 1-92$, $E = 50-30,000$ eV
 See page 211 for Explanation of Tables

μ_a (barns/atom) = μ (cm²/gm) \times 66.55
 E (keV) μ (cm²/gm) = $f_2 \times 1049.91$

Calcium (Ca)
 $Z = 20$
 Atomic Weight = 40.078

Line	E(eV)	μ (cm ² /gm)	f_1	f_2	λ (Å)
H	10.2	4.72e + 3		0.05	1215
He I	21.2	1.01e + 4		0.20	584.3
Na L _{2,3}	30.5	2.39e + 5		6.92	407.2
Mg L _{2,3}	49.3	1.02e + 5		4.78	251.5
Al L _{2,3}	72.4	1.38e + 4	9.12	0.95	171.2
Si L _{2,3}	91.5	2.12e + 4	8.23	1.85	135.5
Be K	108.5	2.25e + 4	8.29	2.33	114.3
Sr M ζ	114.0	2.24e + 4	8.35	2.43	108.8
Y M ζ	132.8	2.05e + 4	8.53	2.59	93.4
Zr M ζ	151.1	1.88e + 4	8.77	2.71	82.1
B K α	183.3	1.44e + 4	9.04	2.51	67.6
Mo M ζ	192.6	1.32e + 4	9.01	2.42	64.4
Ar L ℓ	220.1	1.06e + 4	8.74	2.22	56.3
C K α	277.0	6.95e + 3	7.39	1.83	44.8
Ag M ζ	311.7	5.65e + 3	5.16	1.68	39.8
N K α	392.4	3.57e + 4	8.26	13.34	31.6
Ti L α	452.2	3.01e + 4	12.63	12.97	27.4
V L α	511.3	2.33e + 4	15.44	11.35	24.2
O K α	524.9	2.20e + 4	15.85	11.01	23.6
Cr L α	572.8	1.82e + 4	16.98	9.91	21.6
Mn L α	637.4	1.43e + 4	17.98	8.67	19.5
F K α	676.8	1.24e + 4	18.37	7.98	18.3
Fe L α	705.0	1.13e + 4	18.61	7.60	17.6
Co L α	776.2	9.00e + 3	19.08	6.66	16.0
Ni L α	851.5	7.16e + 3	19.36	5.81	14.6
Cu L α	929.7	5.77e + 3	19.53	5.11	13.3
Zn L α	1011.7	4.68e + 3	19.63	4.51	12.3
Na K α	1041.0	4.36e + 3	19.65	4.32	11.9
Ge L α	1188.0	3.11e + 3	19.69	3.52	10.4
Mg K α	1253.6	2.71e + 3	19.68	3.24	9.9
Al K α	1486.7	1.75e + 3	19.60	2.48	8.3
Si K α	1740.0	1.15e + 3	19.47	1.90	7.1
Zr L α	2042.4	7.41e + 2	19.28	1.44	6.1
Mo L α	2293.2	5.40e + 2	19.11	1.18	5.4
Cl K α	2622.4	3.75e + 2	18.88	0.94	4.7
Ag L α	2984.3	2.65e + 2	18.59	0.75	4.2
Ca K α	3691.7	1.50e + 2	17.56	0.53	3.4
Ti K α	4510.8	8.12e + 2	18.60	3.49	2.7
V K α	4952.2	6.37e + 2	19.39	3.00	2.5
Cr K α	5414.7	5.03e + 2	19.81	2.59	2.3
Mn K α	5898.8	4.00e + 2	20.06	2.25	2.1
Co K α	6930.3	2.58e + 2	20.30	1.71	1.8
Ni K α	7478.2	2.10e + 2	20.35	1.49	1.7
Cu K α	8047.8	1.71e + 2	20.38	1.31	1.5
Ge K α	9886.4	9.65e + 1	20.39	0.91	1.3
Y K α	14988.0	2.96e + 1	20.28	0.42	0.8
Mo K α	17479.0	1.89e + 1	20.23	0.32	0.7
Pd K α	21177.0	1.08e + 1	20.18	0.22	0.6
Sn K α	25271.0	6.36e + 0	20.13	0.15	0.5
Xe K α	29779.0	3.88e + 0	20.10	0.11	0.4

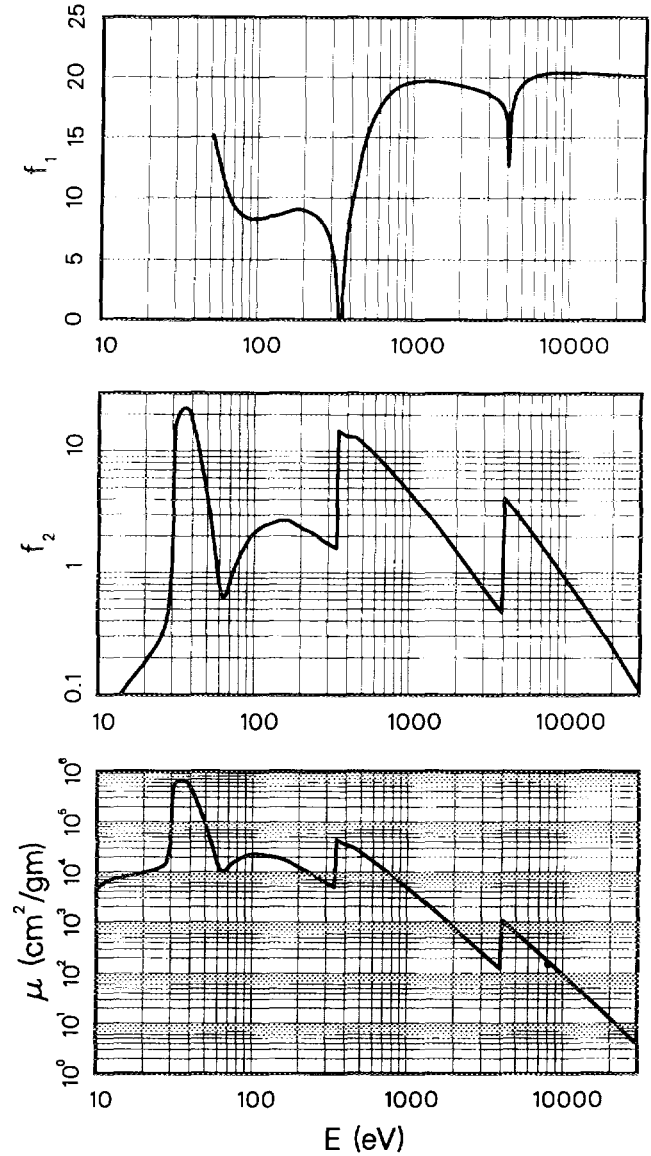

Edge Energies

K	4038.5 eV ^a	L _I	438.4 eV ^b	M _I	44.3 eV ^b
		L _{II}	349.7 eV ^b	M _{II}	25.4 eV ^b
		L _{III}	346.2 eV ^b	M _{III}	25.4 eV ^b

References: 196.

TABLE I. Photoabsorption Cross Sections and Atomic Scattering Factors,
 $Z = 1-92$, $E = 50-30,000$ eV
 See page 211 for Explanation of Tables

$\mu_a(\text{barns/atom}) = \mu(\text{cm}^2/\text{gm}) \times 74.65$
 $E(\text{keV})\mu(\text{cm}^2/\text{gm}) = f_2 \times 935.99$

Scandium (Sc)
 $Z = 21$
 Atomic Weight = 44.956

Line	E(eV)	$\mu(\text{cm}^2/\text{gm})$	f_1	f_2	λ (Å)
H	10.2	6.62e + 4		0.72	1215
He I	21.2	3.57e + 4		0.81	584.3
Na L _{2,3}	30.5	1.95e + 4		0.63	407.2
Mg L _{2,3}	49.3	1.66e + 5		8.76	251.5
Al L _{2,3}	72.4	3.03e + 4	9.96	2.34	171.2
Si L _{2,3}	91.5	2.84e + 4	9.33	2.78	135.5
Be K	108.5	2.50e + 4	9.45	2.89	114.3
Sr M ζ	114.0	2.39e + 4	9.50	2.91	108.8
Y M ζ	132.8	2.07e + 4	9.65	2.93	93.4
Zr M ζ	151.1	1.82e + 4	9.84	2.94	82.1
B K α	183.3	1.42e + 4	10.04	2.78	67.6
Mo M ζ	192.6	1.32e + 4	10.07	2.72	64.4
Ar L l	220.1	1.08e + 4	10.05	2.54	56.3
C K α	277.0	7.45e + 3	9.48	2.20	44.8
Ag M ζ	311.7	6.03e + 3	8.70	2.01	39.8
N K α	392.4	3.98e + 3	-0.54	1.67	31.6
Ti L α	452.2	2.89e + 4	9.41	13.96	27.4
V L α	511.3	2.51e + 4	12.84	13.71	24.2
O K α	524.9	2.36e + 4	14.01	13.25	23.6
Cr L α	572.8	1.95e + 4	16.13	11.93	21.6
Mn L α	637.4	1.54e + 4	17.79	10.46	19.5
F K α	676.8	1.33e + 4	18.43	9.63	18.3
Fe L α	705.0	1.22e + 4	18.80	9.17	17.6
Co L α	776.2	9.72e + 3	19.54	8.06	16.0
Ni L α	851.5	7.75e + 3	20.01	7.05	14.6
Cu L α	929.7	6.25e + 3	20.31	6.21	13.3
Zn L α	1011.7	5.07e + 3	20.50	5.48	12.3
Na K α	1041.0	4.72e + 3	20.54	5.25	11.9
Ge L α	1188.0	3.38e + 3	20.67	4.30	10.4
Mg K α	1253.6	2.96e + 3	20.68	3.96	9.9
Al K α	1486.7	1.91e + 3	20.66	3.04	8.3
Si K α	1740.0	1.27e + 3	20.55	2.37	7.1
Zr L α	2042.4	8.37e + 2	20.40	1.83	6.1
Mo L α	2293.2	6.16e + 2	20.26	1.51	5.4
Cl K α	2622.4	4.31e + 2	20.08	1.21	4.7
Ag L α	2984.3	3.04e + 2	19.86	0.97	4.2
Ca K α	3691.7	1.70e + 2	19.27	0.67	3.4
Ti K α	4510.8	8.47e + 2	14.24	4.08	2.7
V K α	4952.2	6.74e + 2	19.40	3.57	2.5
Cr K α	5414.7	5.38e + 2	20.26	3.11	2.3
Mn K α	5898.8	4.31e + 2	20.72	2.72	2.1
Co K α	6930.3	2.81e + 2	21.17	2.08	1.8
Ni K α	7478.2	2.29e + 2	21.28	1.83	1.7
Cu K α	8047.8	1.87e + 2	21.34	1.61	1.5
Ge K α	9886.4	1.06e + 2	21.41	1.12	1.3
Y K α	14988.0	3.21e + 1	21.32	0.51	0.8
Mo K α	17479.0	2.05e + 1	21.27	0.38	0.7
Pd K α	21177.0	1.17e + 1	21.21	0.26	0.6
Sn K α	25271.0	6.90e + 0	21.16	0.19	0.5
Xe K α	29779.0	4.22e + 0	21.12	0.13	0.4

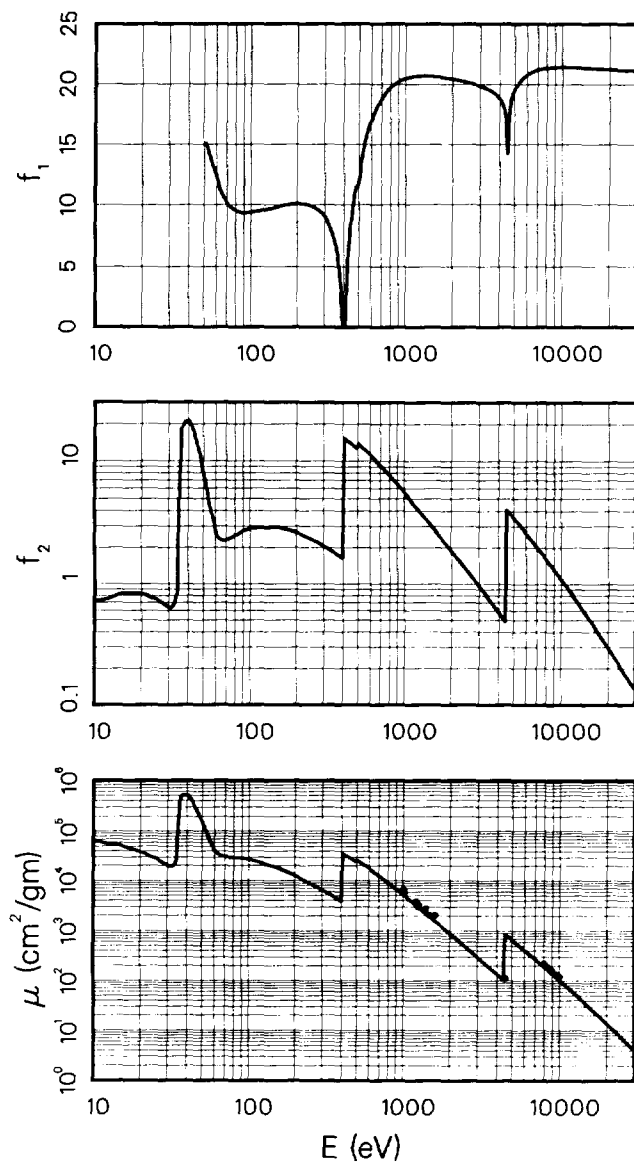

Edge Energies

K	4492.8 eV	L _I	498.0 eV ^a	M _I	51.1 eV ^a
		L _{II}	403.6 eV ^a	M _{II}	28.3 eV ^a
		L _{III}	398.7 eV ^a	M _{III}	28.3 eV ^a

References: 33, 48, 59, 76, 107, 108, 131.

TABLE I. Photoabsorption Cross Sections and Atomic Scattering Factors,
 $Z = 1-92, E = 50-30,000 \text{ eV}$
 See page 211 for Explanation of Tables

$\mu_a(\text{barns/atom}) = \mu(\text{cm}^2/\text{gm}) \times 79.51$
 $E(\text{keV})\mu(\text{cm}^2/\text{gm}) = f_2 \times 378.83$

Titanium (Ti)
 $Z = 22$
 Atomic Weight = 47.880

Line	E(eV)	$\mu(\text{cm}^2/\text{gm})$	f_1	f_2	$\lambda(\text{\AA})$
H	10.2	2.05e+5		2.37	1215
He I	21.2	1.43e+5		3.44	584.3
Na L _{2,3}	30.5	1.36e+5		4.70	407.2
Mg L _{2,3}	49.3	2.34e+5		13.11	251.5
Al L _{2,3}	72.4	4.65e+4	11.22	3.83	171.2
Si L _{2,3}	91.5	3.60e+4	10.14	3.75	135.5
Be K	108.5	3.09e+4	10.36	3.82	114.3
Sr M ζ	114.0	2.91e+4	10.46	3.77	108.8
Y M ζ	132.8	2.42e+4	10.56	3.65	93.4
Zr M ζ	151.1	2.13e+4	10.77	3.66	82.1
B K α	183.3	1.68e+4	11.15	3.50	67.6
Mo M ζ	192.6	1.59e+4	11.23	3.47	64.4
Ar L ℓ	220.1	1.29e+4	11.47	3.23	56.3
C K α	277.0	8.63e+3	11.31	2.72	44.8
Ag M ζ	311.7	6.96e+3	10.94	2.47	39.8
N K α	392.4	4.36e+3	8.68	1.95	31.6
Ti L α	452.2	3.32e+3	-3.18	1.71	27.4
V L α	511.3	2.34e+4	10.73	13.63	24.2
O K α	524.9	2.21e+4	11.68	13.23	23.6
Cr L α	572.8	2.02e+4	13.50	13.18	21.6
Mn L α	637.4	1.67e+4	17.00	12.13	19.5
F K α	676.8	1.46e+4	18.05	11.21	18.3
Fe L α	705.0	1.33e+4	18.64	10.70	17.6
Co L α	776.2	1.07e+4	19.77	9.42	16.0
Ni L α	851.5	8.56e+3	20.49	8.29	14.6
Cu L α	929.7	6.93e+3	20.98	7.33	13.3
Zn L α	1011.7	5.63e+3	21.31	6.48	12.3
Na K α	1041.0	5.25e+3	21.40	6.22	11.9
Ge L α	1188.0	3.77e+3	21.66	5.10	10.4
Mg K α	1253.6	3.30e+3	21.72	4.71	9.9
Al K α	1486.7	2.14e+3	21.79	3.61	8.3
Si K α	1740.0	1.41e+3	21.73	2.80	7.1
Zr L α	2042.4	9.24e+2	21.59	2.15	6.1
Mo L α	2293.2	6.78e+2	21.46	1.77	5.4
Cl K α	2622.4	4.73e+2	21.28	1.41	4.7
Ag L α	2984.3	3.33e+2	21.09	1.13	4.2
Ca K α	3691.7	1.87e+2	20.66	0.79	3.4
Ti K α	4510.8	1.08e+2	19.72	0.56	2.7
V K α	4952.2	2.48e+2	17.61	1.39	2.5
Cr K α	5414.7	5.77e+2	20.30	3.56	2.3
Mn K α	5898.8	4.65e+2	21.20	3.12	2.1
Co K α	6930.3	3.05e+2	21.96	2.41	1.8
Ni K α	7478.2	2.49e+2	22.14	2.12	1.7
Cu K α	8047.8	2.04e+2	22.26	1.87	1.5
Ge K α	9886.4	1.15e+2	22.42	1.30	1.3
Y K α	14988.0	3.48e+1	22.34	0.59	0.8
Mo K α	17479.0	2.23e+1	22.29	0.44	0.7
Pd K α	21177.0	1.27e+1	22.23	0.31	0.6
Sn K α	25271.0	7.54e+0	22.17	0.22	0.5
Xe K α	29779.0	4.63e+0	22.13	0.16	0.4

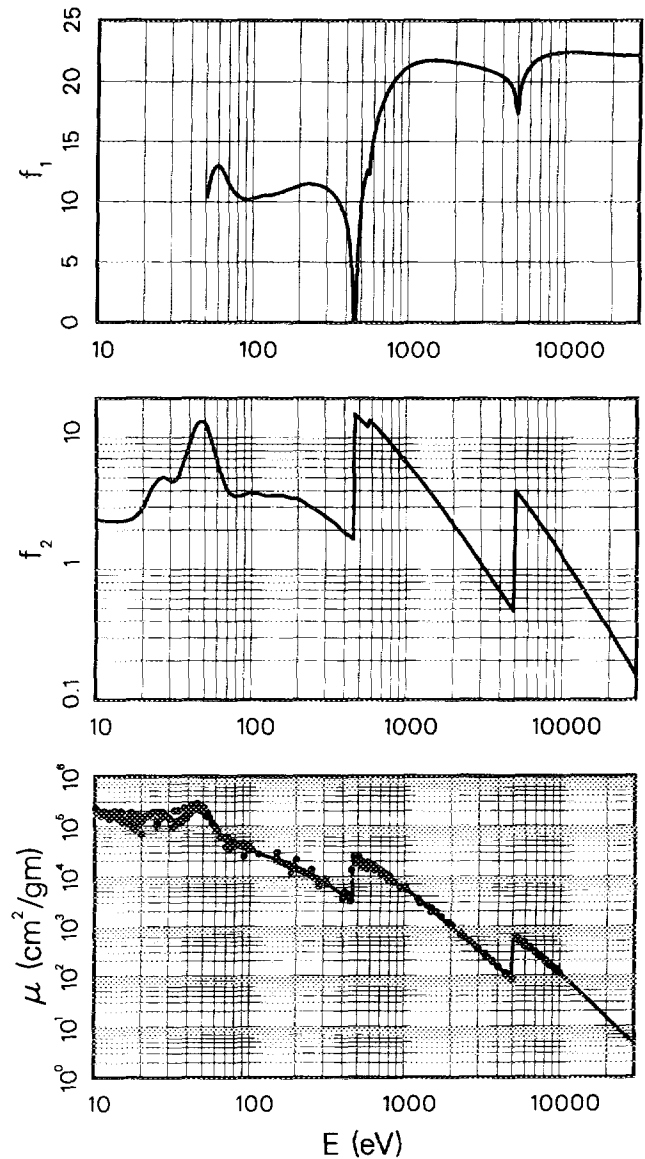

Edge Energies

K	4966.4 eV	L _I	560.9 eV ^b	M _I	58.7 eV ^b
		L _{II}	460.2 eV ^b	M _{II}	32.6 eV ^b
		L _{III}	453.8 eV ^b	M _{III}	32.6 eV ^b

References: 33, 48, 52, 59, 76, 99, 105, 107, 108, 123, 127, 130, 131, 139, 160, 180, 181, 200, 219, 223, 227, 230, 232.

TABLE I. Photoabsorption Cross Sections and Atomic Scattering Factors,
 $Z = 1-92$, $E = 50-30,000$ eV
 See page 211 for Explanation of Tables

$\mu_a(\text{barns/atom}) = \mu(\text{cm}^2/\text{gm}) \times 84.59$
 $E(\text{keV})\mu(\text{cm}^2/\text{gm}) = f_2 \times 826.01$

Vanadium (V)
 $Z = 23$
 Atomic Weight = 50.942

Line	E(eV)	$\mu(\text{cm}^2/\text{gm})$	f_1	f_2	λ (Å)
H	10.2	9.16e + 4		1.13	1215
He I	21.2	1.16e + 5		2.98	584.3
Na L _{2,3}	30.5	4.89e + 4		1.80	407.2
Mg L _{2,3}	49.3	1.30e + 5		7.74	251.5
Al L _{2,3}	72.4	5.50e + 4	9.86	4.82	171.2
Si L _{2,3}	91.5	3.84e + 4	9.65	4.25	135.5
Be K	108.5	3.37e + 4	9.88	4.43	114.3
Sr M ζ	114.0	3.27e + 4	10.01	4.52	108.8
Y M ζ	132.8	2.86e + 4	10.59	4.60	93.4
Zr M ζ	151.1	2.50e + 4	11.03	4.57	82.1
B K α	183.3	1.99e + 4	11.76	4.41	67.6
Mo M ζ	192.6	1.86e + 4	11.94	4.33	64.4
Ar L ℓ	220.1	1.50e + 4	12.30	4.00	56.3
C K α	277.0	1.01e + 4	12.55	3.40	44.8
Ag M ζ	311.7	8.10e + 3	12.47	3.06	39.8
N K α	392.4	5.06e + 3	11.40	2.41	31.6
Ti L α	452.2	3.68e + 3	9.24	2.02	27.4
V L α	511.3	7.23e + 3	0.41	4.47	24.2
O K α	524.9	2.42e + 4	3.24	15.41	23.6
Cr L α	572.8	2.01e + 4	11.20	13.96	21.6
Mn L α	637.4	1.80e + 4	15.12	13.86	19.5
F K α	676.8	1.58e + 4	17.06	12.92	18.3
Fe L α	705.0	1.44e + 4	17.97	12.33	17.6
Co L α	776.2	1.16e + 4	19.63	10.92	16.0
Ni L α	851.5	9.37e + 3	20.70	9.66	14.6
Cu L α	929.7	7.61e + 3	21.43	8.57	13.3
Zn L α	1011.7	6.20e + 3	21.94	7.60	12.3
Na K α	1041.0	5.79e + 3	22.07	7.30	11.9
Ge L α	1188.0	4.18e + 3	22.50	6.01	10.4
Mg K α	1253.6	3.66e + 3	22.62	5.55	9.9
Al K α	1486.7	2.38e + 3	22.80	4.28	8.3
Si K α	1740.0	1.58e + 3	22.80	3.33	7.1
Zr L α	2042.4	1.04e + 3	22.70	2.57	6.1
Mo L α	2293.2	7.64e + 2	22.59	2.12	5.4
Cl K α	2622.4	5.34e + 2	22.43	1.70	4.7
Ag L α	2984.3	3.77e + 2	22.26	1.36	4.2
Ca K α	3691.7	2.12e + 2	21.90	0.95	3.4
Ti K α	4510.8	1.23e + 2	21.34	0.67	2.7
V K α	4952.2	9.50e + 1	20.77	0.57	2.5
Cr K α	5414.7	7.42e + 1	18.18	0.49	2.3
Mn K α	5898.8	5.03e + 2	21.16	3.59	2.1
Co K α	6930.3	3.34e + 2	22.60	2.80	1.8
Ni K α	7478.2	2.74e + 2	22.90	2.48	1.7
Cu K α	8047.8	2.25e + 2	23.10	2.19	1.5
Ge K α	9886.4	1.28e + 2	23.38	1.53	1.3
Y K α	14988.0	3.90e + 1	23.36	0.71	0.8
Mo K α	17479.0	2.50e + 1	23.32	0.53	0.7
Pd K α	21177.0	1.43e + 1	23.25	0.37	0.6
Sn K α	25271.0	8.50e + 0	23.20	0.26	0.5
Xe K α	29779.0	5.22e + 0	23.15	0.19	0.4

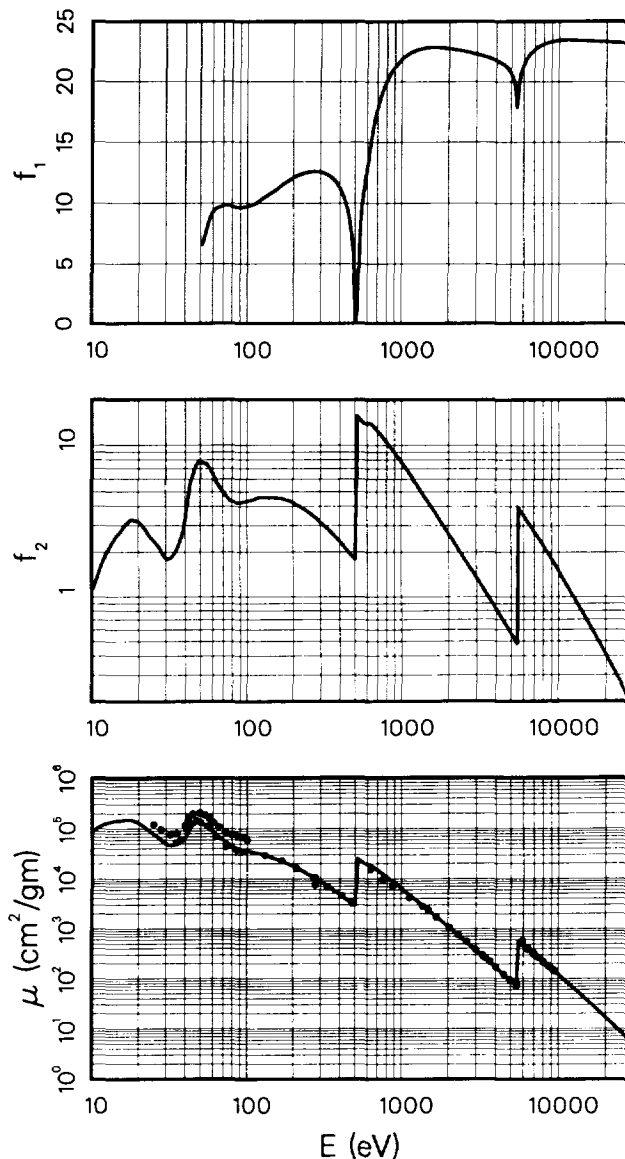

Edge Energies

K	5465.1 eV	L _I	626.7 eV ^b	M _I	66.3 eV ^b
		L _{II}	519.8 eV ^b	M _{II}	37.2 eV ^b
		L _{III}	512.1 eV ^b	M _{III}	37.2 eV ^b

References: 33, 86, 105, 123, 130, 139, 177, 181, 200.

TABLE I. Photoabsorption Cross Sections and Atomic Scattering Factors,
 $Z = 1-92$, $E = 50-30,000$ eV
 See page 211 for Explanation of Tables

$\mu_a(\text{barns/atom}) = \mu(\text{cm}^2/\text{gm}) \times 86.34$
 $E(\text{keV})\mu(\text{cm}^2/\text{gm}) = f_2 \times 809.26$

Chromium (Cr)
 $Z = 24$
 Atomic Weight = 51.996

Line	E(eV)	$\mu(\text{cm}^2/\text{gm})$	f_1	f_2	λ (Å)
H	10.2	8.84e + 4		1.11	1215
He I	21.2	1.60e + 5		4.21	584.3
Na L _{2,3}	30.5	7.41e + 4		2.79	407.2
Mg L _{2,3}	49.3	1.08e + 5		6.59	251.5
Al L _{2,3}	72.4	7.39e + 4	9.32	6.61	171.2
Si L _{2,3}	91.5	5.06e + 4	9.90	5.72	135.5
Be K	108.5	4.18e + 4	10.22	5.60	114.3
Sr M ζ	114.0	4.04e + 4	10.37	5.68	108.8
Y M ζ	132.8	3.48e + 4	11.17	5.72	93.4
Zr M ζ	151.1	2.96e + 4	11.76	5.53	82.1
B K α	183.3	2.24e + 4	12.64	5.08	67.6
Mo M ζ	192.6	2.08e + 4	12.75	4.94	64.4
Ar L ℓ	220.1	1.72e + 4	13.13	4.68	56.3
C K α	277.0	1.19e + 4	13.59	4.07	44.8
Ag M ζ	311.7	9.56e + 3	13.69	3.68	39.8
N K α	392.4	5.85e + 3	13.21	2.84	31.6
Ti L α	452.2	4.40e + 3	12.09	2.46	27.4
V L α	511.3	3.47e + 3	9.90	2.19	24.2
O K α	524.9	3.29e + 3	8.99	2.13	23.6
Cr L α	572.8	1.19e + 4	-0.41	8.40	21.6
Mn L α	637.4	1.80e + 4	12.37	14.15	19.5
F K α	676.8	1.60e + 4	14.07	13.40	18.3
Fe L α	705.0	1.67e + 4	14.78	14.56	17.6
Co L α	776.2	1.37e + 4	18.59	13.14	16.0
Ni L α	851.5	1.12e + 4	20.69	11.76	14.6
Cu L α	929.7	8.93e + 3	21.85	10.26	13.3
Zn L α	1011.7	7.21e + 3	22.61	9.02	12.3
Na K α	1041.0	6.73e + 3	22.79	8.66	11.9
Ge L α	1188.0	4.85e + 3	23.43	7.12	10.4
Mg K α	1253.6	4.25e + 3	23.61	6.58	9.9
Al K α	1486.7	2.76e + 3	23.94	5.07	8.3
Si K α	1740.0	1.83e + 3	24.02	3.93	7.1
Zr L α	2042.4	1.19e + 3	23.94	3.01	6.1
Mo L α	2293.2	8.70e + 2	23.84	2.46	5.4
Cl K α	2622.4	6.03e + 2	23.67	1.95	4.7
Ag L α	2984.3	4.23e + 2	23.49	1.56	4.2
Ca K α	3691.7	2.35e + 2	23.15	1.07	3.4
Ti K α	4510.8	1.36e + 2	22.72	0.76	2.7
V K α	4952.2	1.05e + 2	22.40	0.64	2.5
Cr K α	5414.7	8.27e + 1	21.88	0.55	2.3
Mn K α	5898.8	7.40e + 1	20.12	0.54	2.1
Co K α	6930.3	3.61e + 2	23.04	3.09	1.8
Ni K α	7478.2	2.97e + 2	23.53	2.75	1.7
Cu K α	8047.8	2.45e + 2	23.83	2.44	1.5
Ge K α	9886.4	1.42e + 2	24.22	1.73	1.3
Y K α	14988.0	4.49e + 1	24.36	0.83	0.8
Mo K α	17479.0	2.89e + 1	24.33	0.62	0.7
Pd K α	21177.0	1.66e + 1	24.27	0.43	0.6
Sn K α	25271.0	9.88e + 0	24.21	0.31	0.5
Xe K α	29779.0	6.08e + 0	24.16	0.22	0.4

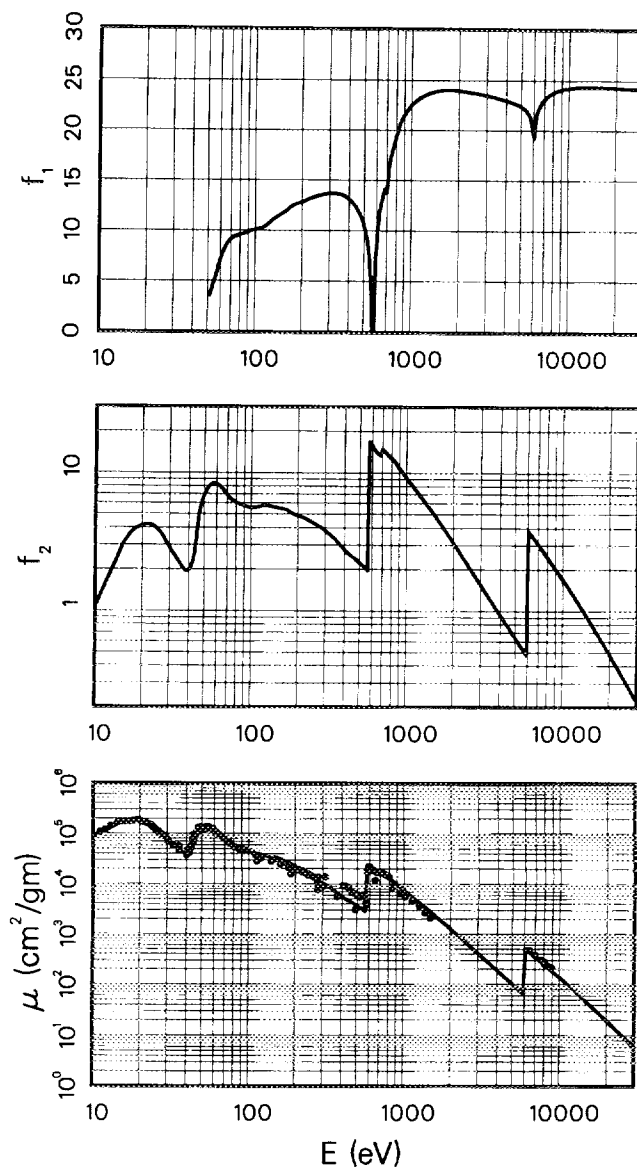

Edge Energies

K	5989.2 eV	L _I	696.0 eV ^b	M _I	74.1 eV ^b
		L _{II}	583.8 eV ^b	M _{II}	42.2 eV ^b
		L _{III}	574.1 eV ^b	M _{III}	42.2 eV ^b

References: 49, 76, 107, 108, 127, 139, 159, 181, 223, 230.

TABLE I. Photoabsorption Cross Sections and Atomic Scattering Factors,
 $Z = 1-92$, $E = 50-30,000$ eV
 See page 211 for Explanation of Tables

Manganese (Mn)
 $Z = 25$
 Atomic Weight = 54.938

μ_a (barns/atom) = μ (cm²/gm) \times 91.23
 E (keV) μ (cm²/gm) = $f_2 \times 765.92$

Line	E(eV)	μ (cm ² /gm)	f_1	f_2	λ (Å)
H	10.2	1.45e+5		1.93	1215
He I	21.2	1.43e+5		3.96	584.3
Na L _{2,3}	30.5	8.21e+4		3.27	407.2
Mg L _{2,3}	49.3	7.52e+4		4.84	251.5
Al L _{2,3}	72.4	5.90e+4	10.19	5.58	171.2
Si L _{2,3}	91.5	4.07e+4	10.31	4.86	135.5
Be K	108.5	3.56e+4	10.34	5.05	114.3
Sr M ζ	114.0	3.47e+4	10.45	5.16	108.8
Y M ζ	132.8	3.20e+4	11.02	5.54	93.4
Zr M ζ	151.1	2.92e+4	11.74	5.76	82.1
B K α	183.3	2.35e+4	12.76	5.62	67.6
Mo M ζ	192.6	2.21e+4	12.99	5.56	64.4
Ar L ℓ	220.1	1.88e+4	13.61	5.42	56.3
C K α	277.0	1.30e+4	14.68	4.71	44.8
Ag M ζ	311.7	1.04e+4	14.91	4.21	39.8
N K α	392.4	6.51e+3	14.78	3.34	31.6
Ti L α	452.2	4.79e+3	14.27	2.83	27.4
V L α	511.3	3.66e+3	13.18	2.45	24.2
O K α	524.9	3.47e+3	12.82	2.38	23.6
Cr L α	572.8	2.90e+3	10.97	2.17	21.6
Mn L α	637.4	1.01e+4	0.18	8.37	19.5
F K α	676.8	1.76e+4	10.30	15.52	18.3
Fe L α	705.0	1.61e+4	13.25	14.80	17.6
Co L α	776.2	1.44e+4	16.25	14.63	16.0
Ni L α	851.5	1.16e+4	19.76	12.87	14.6
Cu L α	929.7	9.47e+3	21.42	11.49	13.3
Zn L α	1011.7	7.76e+3	22.56	10.25	12.3
Na K α	1041.0	7.25e+3	22.87	9.86	11.9
Ge L α	1188.0	5.26e+3	23.88	8.16	10.4
Mg K α	1253.6	4.62e+3	24.16	7.56	9.9
Al K α	1486.7	3.02e+3	24.72	5.87	8.3
Si K α	1740.0	2.03e+3	24.93	4.60	7.1
Zr L α	2042.4	1.33e+3	24.96	3.55	6.1
Mo L α	2293.2	9.76e+2	24.90	2.92	5.4
Cl K α	2622.4	6.78e+2	24.77	2.32	4.7
Ag L α	2984.3	4.77e+2	24.61	1.86	4.2
Ca K α	3691.7	2.66e+2	24.30	1.28	3.4
Ti K α	4510.8	1.53e+2	23.93	0.90	2.7
V K α	4952.2	1.19e+2	23.70	0.77	2.5
Cr K α	5414.7	9.33e+1	23.40	0.66	2.3
Mn K α	5898.8	7.41e+1	22.90	0.57	2.1
Co K α	6930.3	3.94e+2	22.89	3.56	1.8
Ni K α	7478.2	3.25e+2	23.94	3.18	1.7
Cu K α	8047.8	2.70e+2	24.46	2.83	1.5
Ge K α	9886.4	1.57e+2	25.13	2.02	1.3
Y K α	14988.0	4.95e+1	25.37	0.97	0.8
Mo K α	17479.0	3.20e+1	25.35	0.73	0.7
Pd K α	21177.0	1.84e+1	25.29	0.51	0.6
Sn K α	25271.0	1.10e+1	25.23	0.36	0.5
Xe K α	29779.0	6.79e+0	25.18	0.26	0.4

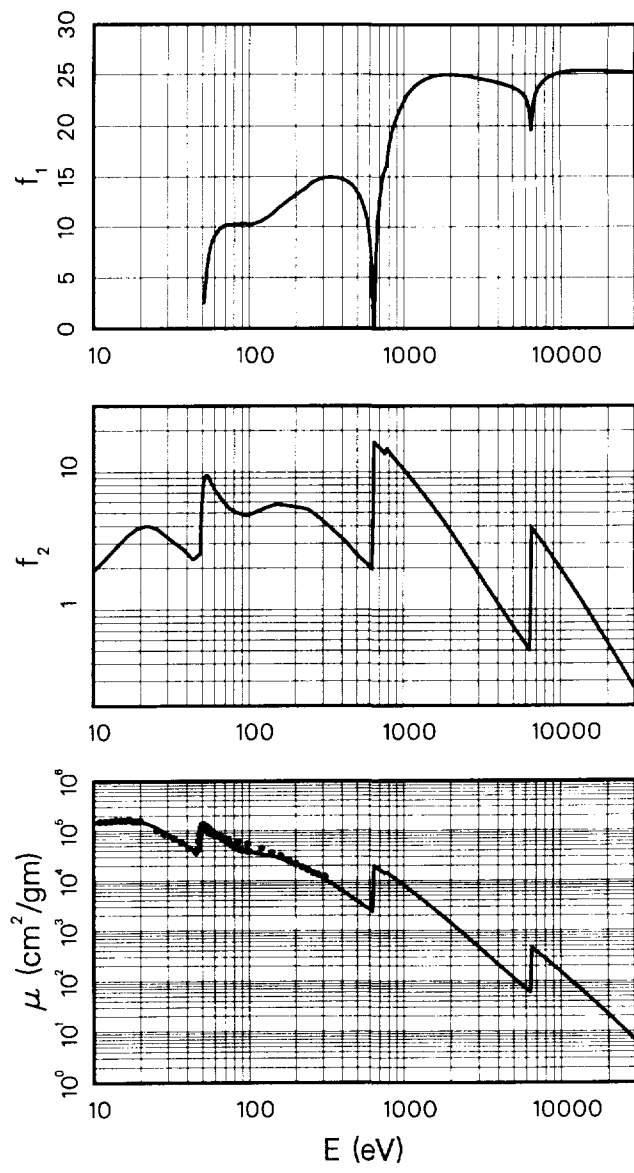

Edge Energies

K	6539.0 eV	L _I	769.1 eV ^b	M _I	82.3 eV ^b
		L _{II}	649.9 eV ^b	M _{II}	47.2 eV ^b
		L _{III}	638.7 eV ^b	M _{III}	47.2 eV ^b

References: 139, 181, 227.

TABLE I. Photoabsorption Cross Sections and Atomic Scattering Factors,
 $Z = 1-92, E = 50-30,000 \text{ eV}$
 See page 211 for Explanation of Tables

$\mu_a(\text{barns/atom}) = \mu(\text{cm}^2/\text{gm}) \times 92.74$
 $E(\text{keV})\mu(\text{cm}^2/\text{gm}) = f_2 \times 753.46$

Iron (Fe)
 $Z = 26$
 Atomic Weight = 55.847

Line	E(eV)	$\mu(\text{cm}^2/\text{gm})$	f_1	f_2	$\lambda (\text{\AA})$
H	10.2	1.06e + 5		1.44	1215
He I	21.2	1.11e + 5		3.13	584.3
Na L _{2,3}	30.5	7.92e + 4		3.20	407.2
Mg L _{2,3}	49.3	3.88e + 4		2.54	251.5
Al L _{2,3}	72.4	7.82e + 4	7.83	7.51	171.2
Si L _{2,3}	91.5	6.19e + 4	8.59	7.52	135.5
Be K	108.5	5.42e + 4	9.60	7.80	114.3
Sr M ζ	114.0	5.20e + 4	9.93	7.87	108.8
Y M ζ	132.8	4.53e + 4	11.12	7.98	93.4
Zr M ζ	151.1	3.93e + 4	12.13	7.89	82.1
B K α	183.3	3.10e + 4	13.52	7.55	67.6
Mo M ζ	192.6	2.90e + 4	13.95	7.42	64.4
Ar L l	220.1	2.29e + 4	14.73	6.70	56.3
C K α	277.0	1.63e + 4	15.68	6.00	44.8
Ag M ζ	311.7	1.30e + 4	16.15	5.39	39.8
N K α	392.4	7.87e + 3	16.38	4.10	31.6
Ti L α	452.2	5.74e + 3	16.06	3.44	27.4
V L α	511.3	4.35e + 3	15.41	2.95	24.2
O K α	524.9	4.09e + 3	15.21	2.85	23.6
Cr L α	572.8	3.36e + 3	14.27	2.55	21.6
Mn L α	637.4	2.67e + 3	11.95	2.26	19.5
F K α	676.8	2.33e + 3	8.66	2.09	18.3
Fe L α	705.0	5.72e + 3	4.16	5.35	17.6
Co L α	776.2	1.45e + 4	14.30	14.97	16.0
Ni L α	851.5	1.25e + 4	17.33	14.10	14.6
Cu L α	929.7	1.07e + 4	20.68	13.19	13.3
Zn L α	1011.7	8.77e + 3	22.39	11.78	12.3
Na K α	1041.0	8.20e + 3	22.84	11.33	11.9
Ge L α	1188.0	5.97e + 3	24.32	9.41	10.4
Mg K α	1253.6	5.24e + 3	24.73	8.72	9.9
Al K α	1486.7	3.44e + 3	25.56	6.78	8.3
Si K α	1740.0	2.31e + 3	25.91	5.32	7.1
Zr L α	2042.4	1.52e + 3	26.01	4.12	6.1
Mo L α	2293.2	1.12e + 3	25.98	3.40	5.4
Cl K α	2622.4	7.80e + 2	25.88	2.72	4.7
Ag L α	2984.3	5.50e + 2	25.74	2.18	4.2
Ca K α	3691.7	3.08e + 2	25.45	1.51	3.4
Ti K α	4510.8	1.78e + 2	25.12	1.07	2.7
V K α	4952.2	1.38e + 2	24.93	0.91	2.5
Cr K α	5414.7	1.08e + 2	24.71	0.77	2.3
Mn K α	5898.8	8.52e + 1	24.42	0.67	2.1
Co K α	6930.3	5.48e + 1	22.44	0.50	1.8
Ni K α	7478.2	3.61e + 2	23.72	3.58	1.7
Cu K α	8047.8	3.00e + 2	24.85	3.21	1.5
Ge K α	9886.4	1.76e + 2	25.94	2.31	1.3
Y K α	14988.0	5.63e + 1	26.37	1.12	0.8
Mo K α	17479.0	3.65e + 1	26.36	0.85	0.7
Pd K α	21177.0	2.10e + 1	26.31	0.59	0.6
Sn K α	25271.0	1.26e + 1	26.25	0.42	0.5
Xe K α	29779.0	7.80e + 0	26.20	0.31	0.4

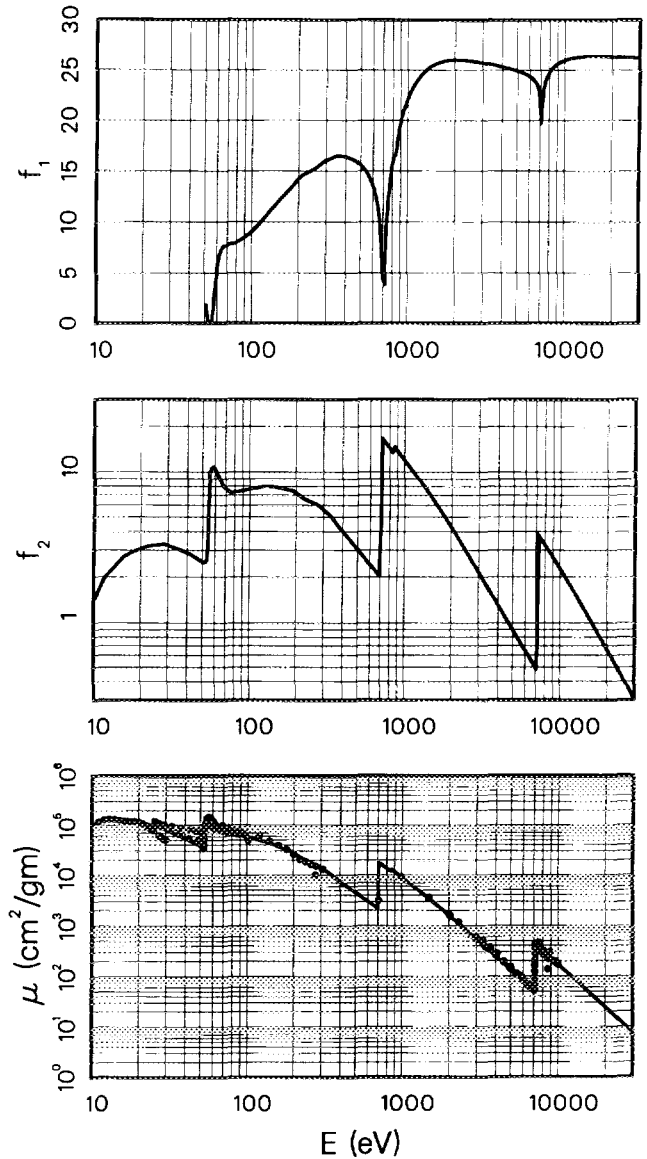

Edge Energies

K	7112.0 eV	L _I	844.6 eV ^b	M _I	91.3 eV ^b
		L _{II}	719.9 eV ^b	M _{II}	52.7 eV ^b
		L _{III}	706.8 eV ^b	M _{III}	52.7 eV ^b

References: 1, 2, 4, 17, 43, 47, 48, 52, 76, 86, 105, 127, 129, 130, 131, 139, 154, 159, 180, 181, 214, 223, 229.

TABLE I. Photoabsorption Cross Sections and Atomic Scattering Factors,
 $Z = 1-92$, $E = 50-30,000$ eV
 See page 211 for Explanation of Tables

Cobalt (Co)
 $Z = 27$
 Atomic Weight = 58.933

$$\mu_a(\text{barns/atom}) = \mu(\text{cm}^2/\text{gm}) \times 97.86$$

$$E(\text{keV})\mu(\text{cm}^2/\text{gm}) = f_2 \times 714.00$$

Line	E(eV)	$\mu(\text{cm}^2/\text{gm})$	f_1	f_2	$\lambda(\text{\AA})$
H	10.2	1.03e + 5		1.47	1215
He I	21.2	1.21e + 5		3.58	584.3
Na L _{2,3}	30.5	1.02e + 5		4.34	407.2
Mg L _{2,3}	49.3	5.64e + 4		3.90	251.5
Al L _{2,3}	72.4	9.23e + 4	7.30	9.36	171.2
Si L _{2,3}	91.5	6.95e + 4	8.92	8.90	135.5
Be K	108.5	5.94e + 4	10.40	9.03	114.3
Sr M ζ	114.0	5.63e + 4	10.82	8.98	108.8
Y M ζ	132.8	4.75e + 4	12.10	8.84	93.4
Zr M ζ	151.1	4.04e + 4	13.14	8.55	82.1
B K α	183.3	3.09e + 4	14.60	7.93	67.6
Mo M ζ	192.6	2.87e + 4	14.94	7.74	64.4
Ar L ℓ	220.1	2.31e + 4	15.74	7.13	56.3
C K α	277.0	1.55e + 4	16.73	6.03	44.8
Ag M ζ	311.7	1.25e + 4	17.05	5.46	39.8
N K α	392.4	8.01e + 3	17.32	4.40	31.6
Ti L α	452.2	6.01e + 3	17.20	3.81	27.4
V L α	511.3	4.66e + 3	16.85	3.33	24.2
O K α	524.9	4.41e + 3	16.74	3.24	23.6
Cr L α	572.8	3.67e + 3	16.21	2.95	21.6
Mn L α	637.4	2.93e + 3	15.10	2.62	19.5
F K α	676.8	2.57e + 3	14.00	2.44	18.3
Fe L α	705.0	2.37e + 3	12.78	2.34	17.6
Co L α	776.2	2.20e + 3	-0.21	2.39	16.0
Ni L α	851.5	1.27e + 4	15.06	15.09	14.6
Cu L α	929.7	1.14e + 4	18.09	14.85	13.3
Zn L α	1011.7	9.44e + 3	21.58	13.38	12.3
Na K α	1041.0	8.83e + 3	22.25	12.87	11.9
Ge L α	1188.0	6.44e + 3	24.43	10.72	10.4
Mg K α	1253.6	5.67e + 3	25.02	9.95	9.9
Al K α	1486.7	3.74e + 3	26.23	7.78	8.3
Si K α	1740.0	2.52e + 3	26.80	6.14	7.1
Zr L α	2042.4	1.66e + 3	27.03	4.76	6.1
Mo L α	2293.2	1.23e + 3	27.06	3.94	5.4
Cl K α	2622.4	8.55e + 2	26.99	3.14	4.7
Ag L α	2984.3	6.02e + 2	26.87	2.52	4.2
Ca K α	3691.7	3.36e + 2	26.60	1.74	3.4
Ti K α	4510.8	1.94e + 2	26.29	1.22	2.7
V K α	4952.2	1.50e + 2	26.12	1.04	2.5
Cr K α	5414.7	1.17e + 2	25.94	0.89	2.3
Mn K α	5898.8	9.26e + 1	25.72	0.77	2.1
Co K α	6930.3	5.96e + 1	24.98	0.58	1.8
Ni K α	7478.2	4.85e + 1	23.83	0.51	1.7
Cu K α	8047.8	3.16e + 2	24.52	3.56	1.5
Ge K α	9886.4	1.88e + 2	26.63	2.60	1.3
Y K α	14988.0	6.15e + 1	27.34	1.29	0.8
Mo K α	17479.0	3.99e + 1	27.36	0.98	0.7
Pd K α	21177.0	2.31e + 1	27.33	0.69	0.6
Sn K α	25271.0	1.39e + 1	27.27	0.49	0.5
Xe K α	29779.0	8.60e + 0	27.22	0.36	0.4

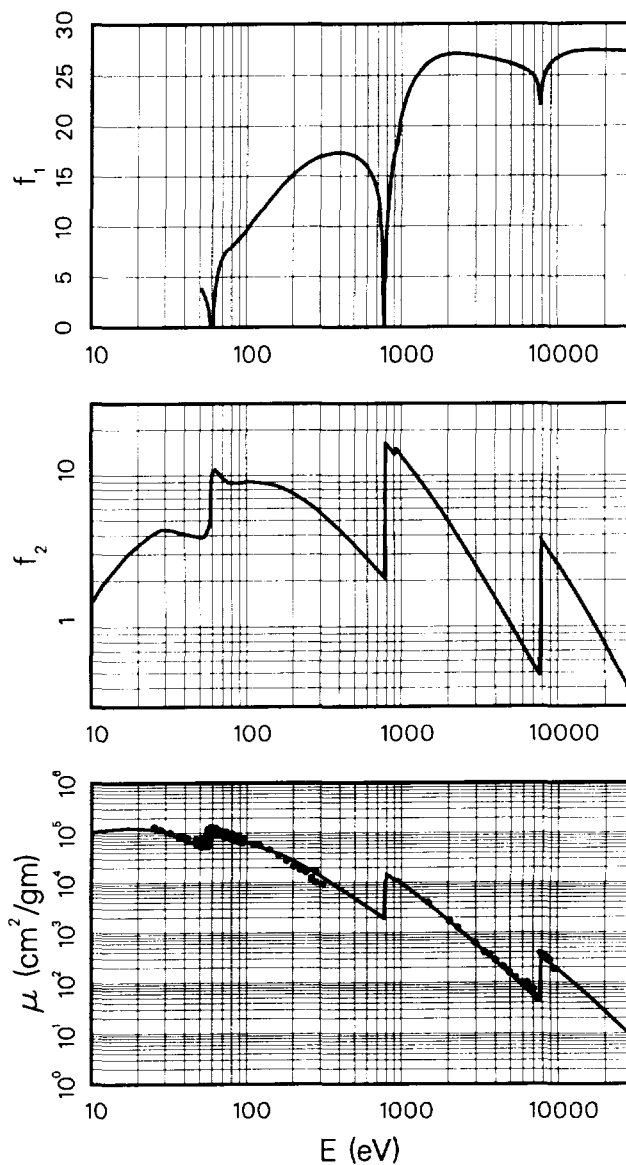

Edge Energies

K	7708.9 eV	L _I	925.1 eV ^b	M _I	101.0 eV ^b
		L _{II}	793.2 eV ^b	M _{II}	58.9 eV ^b
		L _{III}	778.1 eV ^b	M _{III}	58.9 eV ^b

References: 49, 86, 105, 123, 127, 139, 181, 200, 214.

TABLE I. Photoabsorption Cross Sections and Atomic Scattering Factors,
 $Z = 1-92$, $E = 50-30,000$ eV
 See page 211 for Explanation of Tables

$\mu_a(\text{barns/atom}) = \mu(\text{cm}^2/\text{gm}) \times 97.46$
 $E(\text{keV})\mu(\text{cm}^2/\text{gm}) = f_2 \times 716.92$

Nickel (Ni)
 $Z = 28$
 Atomic Weight = 58.693

Line	E(eV)	$\mu(\text{cm}^2/\text{gm})$	f_1	f_2	$\lambda(\text{\AA})$
H	10.2	8.01e+4		1.14	1215
He I	21.2	1.07e+5		3.17	584.3
Na L _{2,3}	30.5	8.55e+4		3.63	407.2
Mg L _{2,3}	49.3	5.13e+4		3.52	251.5
Al L _{2,3}	72.4	9.02e+4	2.69	9.11	171.2
Si L _{2,3}	91.5	7.64e+4	6.88	9.75	135.5
Be K	108.5	6.51e+4	8.54	9.85	114.3
Sr M ζ	114.0	6.19e+4	9.01	9.85	108.8
Y M ζ	132.8	5.26e+4	10.23	9.75	93.4
Zr M ζ	151.1	4.85e+4	11.19	10.22	82.1
B K α	183.3	3.96e+4	13.48	10.12	67.6
Mo M ζ	192.6	3.73e+4	13.99	10.02	64.4
Ar L ℓ	220.1	3.09e+4	15.46	9.48	56.3
C K α	277.0	2.13e+4	17.20	8.24	44.8
Ag M ζ	311.7	1.71e+4	17.98	7.42	39.8
N K α	392.4	1.07e+4	18.71	5.86	31.6
Ti L α	452.2	7.90e+3	18.79	4.98	27.4
V L α	511.3	6.02e+3	18.70	4.29	24.2
O K α	524.9	5.64e+3	18.64	4.13	23.6
Cr L α	572.8	4.54e+3	18.29	3.63	21.6
Mn L α	637.4	3.53e+3	17.51	3.14	19.5
F K α	676.8	3.10e+3	16.90	2.92	18.3
Fe L α	705.0	2.83e+3	16.36	2.79	17.6
Co L α	776.2	2.17e+3	13.96	2.35	16.0
Ni L α	851.5	5.46e+3	5.41	6.48	14.6
Cu L α	929.7	1.18e+4	15.95	15.24	13.3
Zn L α	1011.7	1.09e+4	18.86	15.37	12.3
Na K α	1041.0	1.02e+4	20.60	14.80	11.9
Ge L α	1188.0	7.41e+3	24.28	12.28	10.4
Mg K α	1253.6	6.51e+3	25.15	11.38	9.9
Al K α	1486.7	4.28e+3	26.88	8.88	8.3
Si K α	1740.0	2.87e+3	27.66	6.98	7.1
Zr L α	2042.4	1.90e+3	27.98	5.41	6.1
Mo L α	2293.2	1.40e+3	28.05	4.49	5.4
Cl K α	2622.4	9.86e+2	28.02	3.61	4.7
Ag L α	2984.3	7.01e+2	27.92	2.92	4.2
Ca K α	3691.7	3.97e+2	27.68	2.05	3.4
Ti K α	4510.8	2.32e+2	27.41	1.46	2.7
V K α	4952.2	1.80e+2	27.26	1.24	2.5
Cr K α	5414.7	1.41e+2	27.11	1.07	2.3
Mn K α	5898.8	1.12e+2	26.93	0.92	2.1
Co K α	6930.3	7.14e+1	26.45	0.69	1.8
Ni K α	7478.2	5.76e+1	26.01	0.60	1.7
Cu K α	8047.8	4.67e+1	24.93	0.52	1.5
Ge K α	9886.4	2.15e+2	27.27	2.96	1.3
Y K α	14988.0	7.03e+1	28.31	1.47	0.8
Mo K α	17479.0	4.58e+1	28.36	1.12	0.7
Pd K α	21177.0	2.66e+1	28.34	0.79	0.6
Sn K α	25271.0	1.60e+1	28.29	0.56	0.5
Xe K α	29779.0	9.95e+0	28.24	0.41	0.4

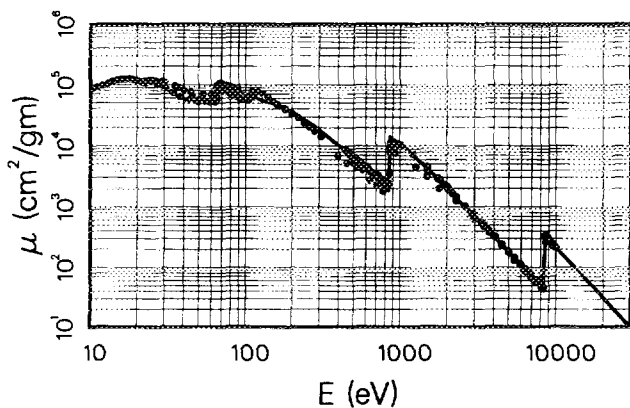
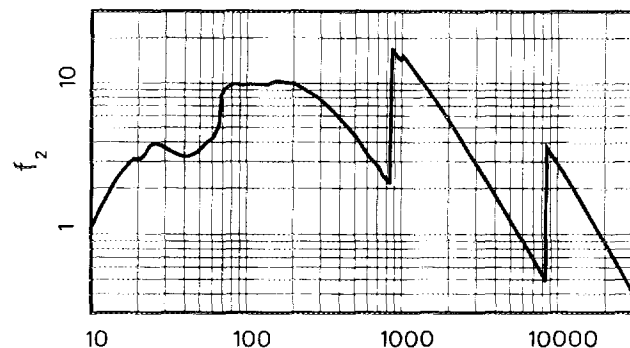
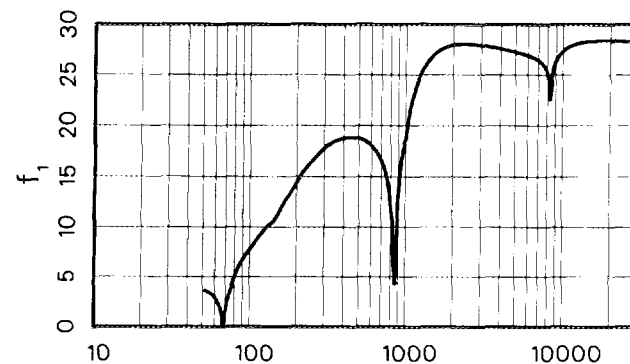

Edge Energies

K	8332.8 eV	L _I	1008.6 eV ^b	M _I	110.8 eV ^b
		L _{II}	870.0 eV ^b	M _{II}	68.0 eV ^b
		L _{III}	852.7 eV ^b	M _{III}	66.2 eV ^b

References: 2, 4, 5, 17, 21, 31, 33, 43, 48, 49, 76, 86, 99, 105, 108, 123, 130, 139, 180, 181, 200, 214, 222, 223, 229, 230, 231.

TABLE I. Photoabsorption Cross Sections and Atomic Scattering Factors,
 $Z = 1-92, E = 50-30,000 \text{ eV}$
 See page 211 for Explanation of Tables

$\mu_a(\text{barns/atom}) = \mu(\text{cm}^2/\text{gm}) \times 105.52$
 $E(\text{keV})\mu(\text{cm}^2/\text{gm}) = f_2 \times 662.17$

Copper (Cu)
 $Z = 29$
 Atomic Weight = 63.546

Line	E(eV)	$\mu(\text{cm}^2/\text{gm})$	f_1	f_2	$\lambda(\text{\AA})$
H	10.2	8.71e+4		1.34	1215
He I	21.2	9.95e+4		3.19	584.3
Na L _{2,3}	30.5	1.07e+5		4.92	407.2
Mg L _{2,3}	49.3	7.60e+4		5.66	251.5
Al L _{2,3}	72.4	6.96e+4	4.39	7.61	171.2
Si L _{2,3}	91.5	6.38e+4	5.39	8.81	135.5
Be K	108.5	6.19e+4	6.52	10.14	114.3
Sr M ζ	114.0	6.12e+4	6.97	10.54	108.8
Y M ζ	132.8	5.78e+4	8.80	11.59	93.4
Zr M ζ	151.1	5.32e+4	10.82	12.13	82.1
B K α	183.3	4.24e+4	13.86	11.75	67.6
Mo M ζ	192.6	3.94e+4	14.50	11.47	64.4
Ar L ℓ	220.1	3.16e+4	15.98	10.51	56.3
C K α	277.0	2.14e+4	17.74	8.95	44.8
Ag M ζ	311.7	1.74e+4	18.42	8.17	39.8
N K α	392.4	1.13e+4	19.29	6.68	31.6
Ti L α	452.2	8.33e+3	19.57	5.69	27.4
V L α	511.3	6.58e+3	19.50	5.08	24.2
O K α	524.9	6.23e+3	19.50	4.94	23.6
Cr L α	572.8	5.19e+3	19.37	4.49	21.6
Mn L α	637.4	4.07e+3	19.00	3.92	19.5
F K α	676.8	3.53e+3	18.64	3.61	18.3
Fe L α	705.0	3.20e+3	18.27	3.41	17.6
Co L α	776.2	2.64e+3	17.04	3.09	16.0
Ni L α	851.5	2.12e+3	14.58	2.73	14.6
Cu L α	929.7	9.20e+2	0.13	12.91	13.3
Zn L α	1011.7	1.04e+4	17.51	15.85	12.3
Na K α	1041.0	9.57e+3	18.90	15.05	11.9
Ge L α	1188.0	7.63e+3	22.99	13.70	10.4
Mg K α	1253.6	6.94e+3	24.45	13.13	9.9
Al K α	1486.7	4.55e+3	27.26	10.23	8.3
Si K α	1740.0	3.07e+3	28.38	8.07	7.1
Zr L α	2042.4	2.04e+3	28.92	6.28	6.1
Mo L α	2293.2	1.51e+3	29.08	5.22	5.4
Cl K α	2622.4	1.06e+3	29.11	4.19	4.7
Ag L α	2984.3	7.51e+2	29.05	3.39	4.2
Ca K α	3691.7	4.25e+2	28.83	2.37	3.4
Ti K α	4510.8	2.48e+2	28.56	1.69	2.7
V K α	4952.2	1.92e+2	28.42	1.44	2.5
Cr K α	5414.7	1.51e+2	28.27	1.23	2.3
Mn K α	5898.8	1.19e+2	28.11	1.06	2.1
Co K α	6930.3	7.61e+1	27.73	0.80	1.8
Ni K α	7478.2	6.15e+1	27.46	0.69	1.7
Cu K α	8047.8	5.00e+1	27.04	0.61	1.5
Ge K α	9886.4	2.23e+2	27.60	3.33	1.3
Y K α	14988.0	7.37e+1	29.26	1.67	0.8
Mo K α	17479.0	4.82e+1	29.34	1.27	0.7
Pd K α	21177.0	2.81e+1	29.35	0.90	0.6
Sn K α	25271.0	1.69e+1	29.31	0.65	0.5
Xe K α	29779.0	1.06e+1	29.26	0.47	0.4

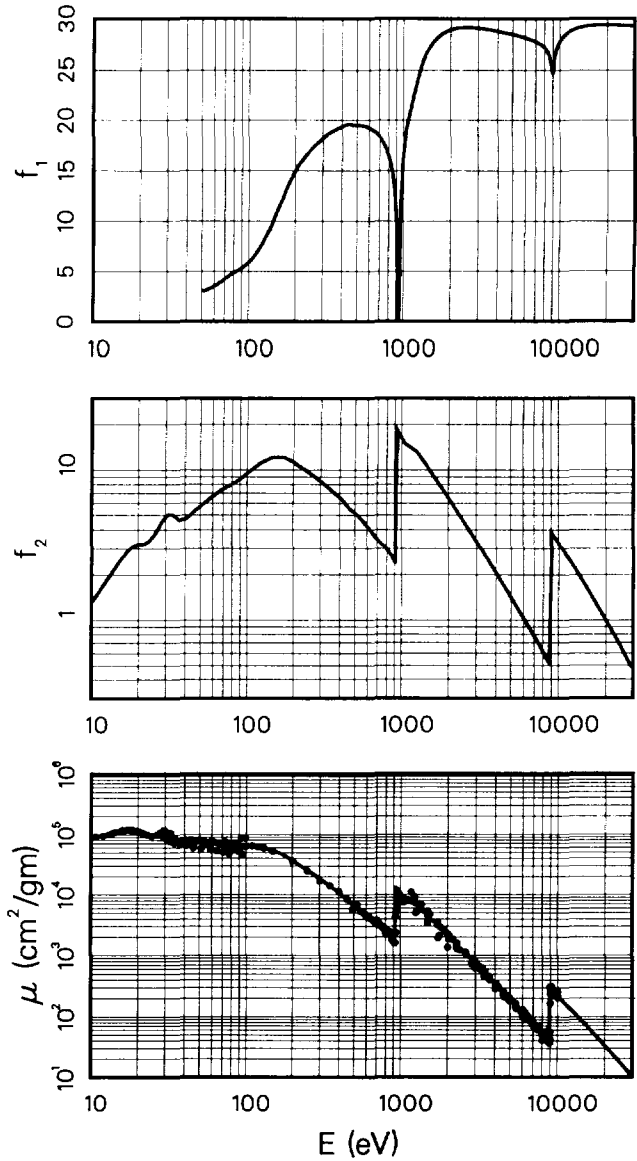

Edge Energies

K	8978.9 eV	L _I	1096.7 eV ^b	M _I	122.5 eV ^b
		L _{II}	952.3 eV ^b	M _{II}	77.3 eV ^b
		L _{III}	932.5 eV ^b	M _{III}	75.1 eV ^b

References: 1, 4, 5, 10, 21, 27, 28, 47, 48, 49, 63, 69, 73, 76, 86, 95, 99, 103, 122, 123, 130, 131, 139, 152, 156, 175, 177, 180, 181, 185, 201, 205, 214, 216, 217, 230, 231.

TABLE I. Photoabsorption Cross Sections and Atomic Scattering Factors,
 $Z = 1-92$, $E = 50-30,000$ eV
 See page 211 for Explanation of Tables

Zinc (Zn)

$Z = 30$

Atomic Weight = 65.390

μ_a (barns/atom) = μ (cm²/gm) \times 108.58
 E (keV) μ (cm²/gm) = $f_2 \times 643.50$

Line	E(eV)	μ (cm ² /gm)	f_1	f_2	λ (Å)
H	10.2	1.32e + 5		2.10	1215
He I	21.2	6.66e + 4		2.20	584.3
Na L _{2,3}	30.5	8.23e + 4		3.89	407.2
Mg L _{2,3}	49.3	9.37e + 4		7.18	251.5
Al L _{2,3}	72.4	8.11e + 4	3.25	9.13	171.2
Si L _{2,3}	91.5	7.25e + 4	4.72	10.31	135.5
Be K	108.5	6.78e + 4	6.22	11.43	114.3
Sr M ζ	114.0	6.59e + 4	6.74	11.68	108.8
Y M ζ	132.8	5.85e + 4	8.46	12.07	93.4
Zr M ζ	151.1	5.67e + 4	9.95	13.30	82.1
B K α	183.3	4.71e + 4	13.11	13.42	67.6
Mo M ζ	192.6	4.43e + 4	13.91	13.25	64.4
Ar L l	220.1	3.66e + 4	16.10	12.51	56.3
C K α	277.0	2.47e + 4	18.30	10.61	44.8
Ag M ζ	311.7	2.01e + 4	19.22	9.75	39.8
N K α	392.4	1.31e + 4	20.65	7.98	31.6
Ti L α	452.2	9.59e + 3	21.12	6.74	27.4
V L α	511.3	7.10e + 3	21.23	5.64	24.2
O K α	524.9	6.65e + 3	21.20	5.42	23.6
Cr L α	572.8	5.40e + 3	20.96	4.81	21.6
Mn L α	637.4	4.27e + 3	20.60	4.23	19.5
F K α	676.8	3.72e + 3	20.30	3.91	18.3
Fe L α	705.0	3.42e + 3	20.06	3.75	17.6
Co L α	776.2	2.78e + 3	19.33	3.36	16.0
Ni L α	851.5	2.24e + 3	18.10	2.96	14.6
Cu L α	929.7	1.82e + 3	15.71	2.63	13.3
Zn L α	1011.7	1.52e + 3	1.57	2.39	12.3
Na K α	1041.0	1.05e + 4	10.12	16.99	11.9
Ge L α	1188.0	8.34e + 3	21.29	15.40	10.4
Mg K α	1253.6	7.57e + 3	23.42	14.74	9.9
Al K α	1486.7	5.02e + 3	27.30	11.59	8.3
Si K α	1740.0	3.41e + 3	28.92	9.21	7.1
Zr L α	2042.4	2.27e + 3	29.73	7.20	6.1
Mo L α	2293.2	1.68e + 3	30.02	6.00	5.4
Cl K α	2622.4	1.18e + 3	30.14	4.83	4.7
Ag L α	2984.3	8.41e + 2	30.13	3.90	4.2
Ca K α	3691.7	4.76e + 2	29.95	2.73	3.4
Ti K α	4510.8	2.77e + 2	29.69	1.94	2.7
V K α	4952.2	2.15e + 2	29.56	1.65	2.5
Cr K α	5414.7	1.69e + 2	29.42	1.42	2.3
Mn K α	5898.8	1.33e + 2	29.27	1.22	2.1
Co K α	6930.3	8.54e + 1	28.94	0.92	1.8
Ni K α	7478.2	6.91e + 1	28.74	0.80	1.7
Cu K α	8047.8	5.62e + 1	28.47	0.70	1.5
Ge K α	9886.4	2.44e + 2	26.29	3.74	1.3
Y K α	14988.0	8.08e + 1	30.17	1.88	0.8
Mo K α	17479.0	5.30e + 1	30.31	1.44	0.7
Pd K α	21177.0	3.10e + 1	30.35	1.02	0.6
Sn K α	25271.0	1.87e + 1	30.32	0.74	0.5
Xe K α	29779.0	1.17e + 1	30.27	0.54	0.4

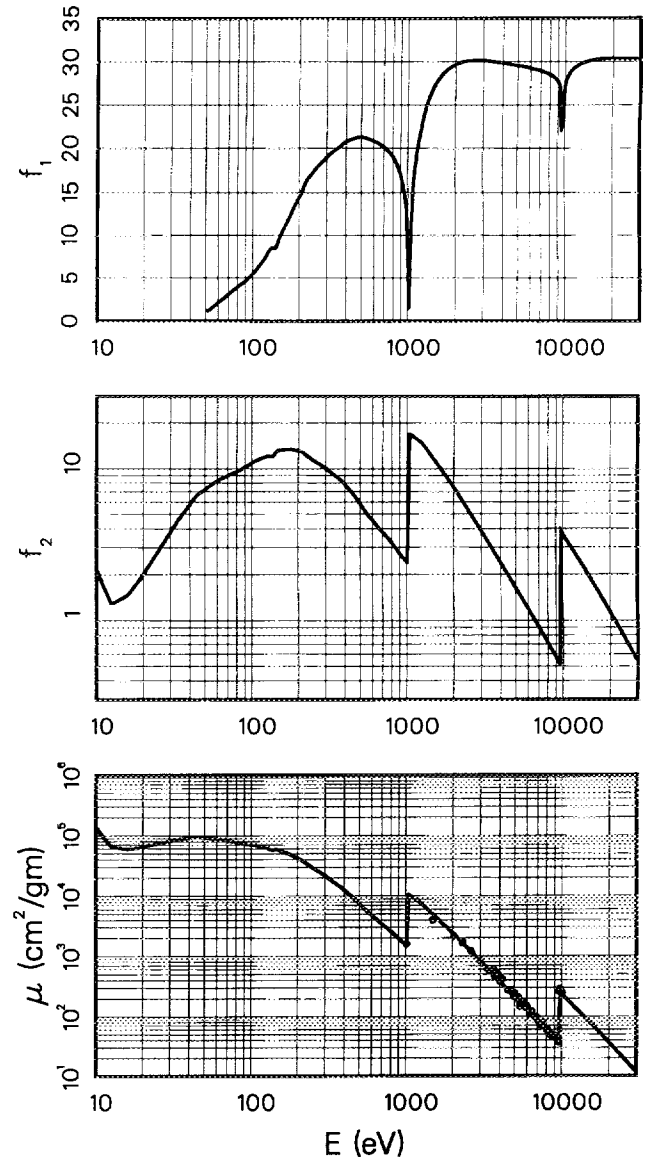

Edge Energies

K	9658.6 eV	L _I	1193.6 eV	M _I	139.8 eV ^a
		L _{II}	1044.9 eV ^a	M _{II}	91.4 eV ^a
		L _{III}	1021.8 eV ^a	M _{III}	88.6 eV ^a
				M _{IV}	10.2 eV ^a
				M _V	10.1 eV ^a

References: 1, 2, 4, 10, 17, 49, 52, 90, 131, 156, 159, 175, 180.

TABLE I. Photoabsorption Cross Sections and Atomic Scattering Factors,
 $Z = 1-92$, $E = 50-30,000$ eV
 See page 211 for Explanation of Tables

$\mu_a(\text{barns/atom}) = \mu(\text{cm}^2/\text{gm}) \times 115.78$
 $E(\text{keV})\mu(\text{cm}^2/\text{gm}) = f_2 \times 603.51$

Gallium (Ga)
 $Z = 31$
 Atomic Weight = 69.723

Line	E(eV)	$\mu(\text{cm}^2/\text{gm})$	f_1	f_2	$\lambda(\text{\AA})$
H	10.2	1.76e + 5		2.98	1215
He I	21.2	3.70e + 4		1.30	584.3
Na L _{2,3}	30.5	3.83e + 4		1.93	407.2
Mg L _{2,3}	49.3	5.70e + 4		4.65	251.5
Al L _{2,3}	72.4	6.17e + 4	2.39	7.40	171.2
Si L _{2,3}	91.5	6.00e + 4	3.44	9.10	135.5
Be K	108.5	6.06e + 4	4.61	10.90	114.3
Sr M ζ	114.0	6.06e + 4	5.22	11.45	108.8
Y M ζ	132.8	5.72e + 4	7.16	12.59	93.4
Zr M ζ	151.1	5.24e + 4	9.22	13.11	82.1
B K α	183.3	4.40e + 4	11.94	13.36	67.6
Mo M ζ	192.6	4.17e + 4	12.61	13.31	64.4
Ar L ℓ	220.1	3.61e + 4	14.32	13.17	56.3
C K α	277.0	2.72e + 4	17.49	12.48	44.8
Ag M ζ	311.7	2.30e + 4	19.02	11.85	39.8
N K α	392.4	1.49e + 4	21.18	9.71	31.6
Ti L α	452.2	1.12e + 4	21.95	8.37	27.4
V L α	511.3	8.68e + 3	22.34	7.35	24.2
O K α	524.9	8.21e + 3	22.42	7.14	23.6
Cr L α	572.8	6.76e + 3	22.57	6.41	21.6
Mn L α	637.4	5.31e + 3	22.57	5.60	19.5
F K α	676.8	4.61e + 3	22.55	5.17	18.3
Fe L α	705.0	4.11e + 3	22.47	4.80	17.6
Co L α	776.2	3.12e + 3	21.98	4.01	16.0
Ni L α	851.5	2.45e + 3	21.10	3.45	14.6
Cu L α	929.7	1.99e + 3	19.91	3.06	13.3
Zn L α	1011.7	1.63e + 3	17.83	2.73	12.3
Na K α	1041.0	1.53e + 3	16.57	2.63	11.9
Ge L α	1188.0	7.63e + 3	17.50	15.02	10.4
Mg K α	1253.6	6.99e + 3	20.32	14.52	9.9
Al K α	1486.7	5.29e + 3	26.78	13.04	8.3
Si K α	1740.0	3.60e + 3	29.22	10.37	7.1
Zr L α	2042.4	2.40e + 3	30.42	8.11	6.1
Mo L α	2293.2	1.78e + 3	30.85	6.76	5.4
Cl K α	2622.4	1.25e + 3	31.09	5.44	4.7
Ag L α	2984.3	8.91e + 2	31.14	4.41	4.2
Ca K α	3691.7	5.05e + 2	31.02	3.09	3.4
Ti K α	4510.8	2.95e + 2	30.79	2.20	2.7
V K α	4952.2	2.29e + 2	30.66	1.88	2.5
Cr K α	5414.7	1.80e + 2	30.52	1.61	2.3
Mn K α	5898.8	1.42e + 2	30.40	1.39	2.1
Co K α	6930.3	9.12e + 1	30.11	1.05	1.8
Ni K α	7478.2	7.39e + 1	29.93	0.92	1.7
Cu K α	8047.8	6.01e + 1	29.72	0.80	1.5
Ge K α	9886.4	3.34e + 1	28.23	0.55	1.3
Y K α	14988.0	8.53e + 1	31.04	2.12	0.8
Mo K α	17479.0	5.61e + 1	31.25	1.63	0.7
Pd K α	21177.0	3.30e + 1	31.33	1.16	0.6
Sn K α	25271.0	2.00e + 1	31.32	0.84	0.5
Xe K α	29779.0	1.25e + 1	31.28	0.62	0.4

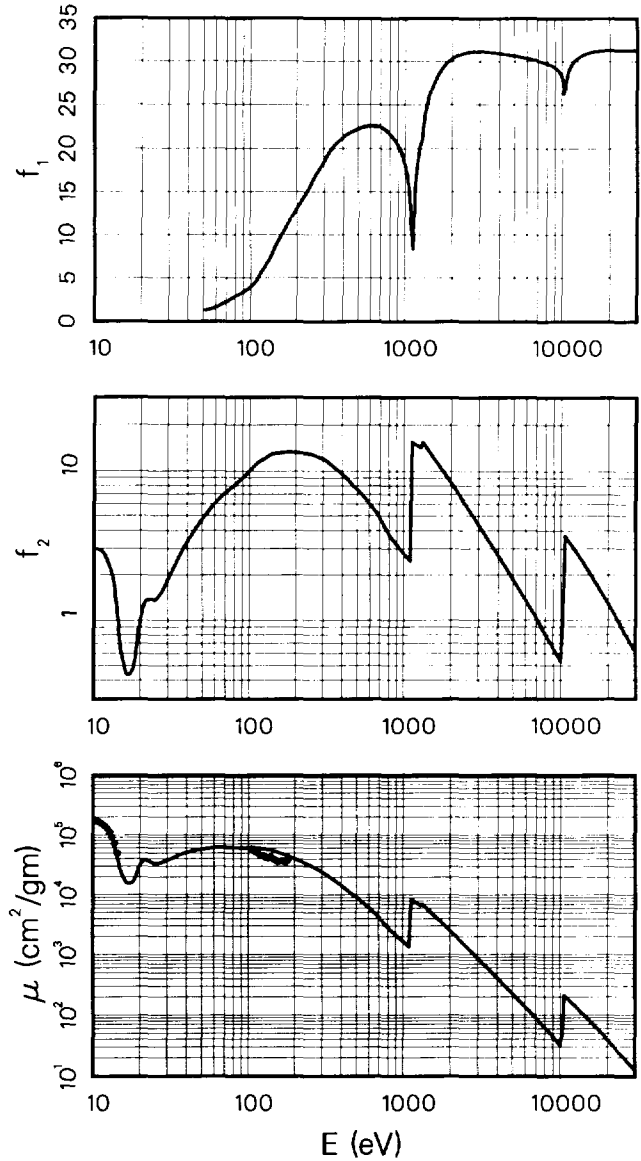

Edge Energies

K	10367.1 eV	L _I	1299.0 eV ^a	M _I	159.4 eV ^a
		L _{II}	1143.6 eV ^a	M _{II}	107.3 eV ^a
		L _{III}	1116.7 eV ^a	M _{III}	104.2 eV ^a
				M _{IV}	18.7 eV ^a
				M _V	18.3 eV ^a

References: 43, 197.

TABLE I. Photoabsorption Cross Sections and Atomic Scattering Factors,
 $Z = 1-92$, $E = 50-30,000$ eV
 See page 211 for Explanation of Tables

Germanium (Ge)
 $Z = 32$

Atomic Weight = 72.610

μ_a (barns/atom) = μ (cm²/gm) \times 120.57
 E (keV) μ (cm²/gm) = $f_2 \times 579.51$

Line	E(eV)	μ (cm ² /gm)	f_1	f_2	λ (Å)
H	10.2	1.74e + 5		3.06	1215
He I	21.2	2.54e + 4		0.93	584.3
Na L _{2,3}	30.5	3.21e + 4		1.69	407.2
Mg L _{2,3}	49.3	3.75e + 4		3.19	251.5
Al L _{2,3}	72.4	5.35e + 4	0.57	6.69	171.2
Si L _{2,3}	91.5	5.61e + 4	1.51	8.85	135.5
Be K	108.5	5.71e + 4	2.56	10.69	114.3
Sr M ζ	114.0	5.73e + 4	2.95	11.26	108.8
Y M ζ	132.8	5.71e + 4	4.63	13.08	93.4
Zr M ζ	151.1	5.58e + 4	6.55	14.54	82.1
B K α	183.3	4.94e + 4	9.96	15.64	67.6
Mo M ζ	192.6	4.79e + 4	10.95	15.92	64.4
Ar L ℓ	220.1	4.13e + 4	13.70	15.69	56.3
C K α	277.0	3.09e + 4	17.85	14.78	44.8
Ag M ζ	311.7	2.51e + 4	19.55	13.51	39.8
N K α	392.4	1.66e + 4	21.88	11.26	31.6
Ti L α	452.2	1.26e + 4	23.01	9.82	27.4
V L α	511.3	9.58e + 3	23.55	8.45	24.2
O K α	524.9	9.04e + 3	23.62	8.19	23.6
Cr L α	572.8	7.44e + 3	23.81	7.35	21.6
Mn L α	637.4	5.76e + 3	23.86	6.34	19.5
F K α	676.8	4.99e + 3	23.78	5.83	18.3
Fe L α	705.0	4.52e + 3	23.70	5.50	17.6
Co L α	776.2	3.56e + 3	23.39	4.77	16.0
Ni L α	851.5	2.82e + 3	22.87	4.15	14.6
Cu L α	929.7	2.24e + 3	22.11	3.60	13.3
Zn L α	1011.7	1.83e + 3	20.90	3.19	12.3
Na K α	1041.0	1.71e + 3	20.34	3.07	11.9
Ge L α	1188.0	1.29e + 3	12.88	2.64	10.4
Mg K α	1253.6	7.60e + 3	14.81	16.44	9.9
Al K α	1486.7	5.69e + 3	25.52	14.59	8.3
Si K α	1740.0	3.93e + 3	29.26	11.79	7.1
Zr L α	2042.4	2.63e + 3	31.01	9.28	6.1
Mo L α	2293.2	1.96e + 3	31.68	7.75	5.4
Cl K α	2622.4	1.38e + 3	32.07	6.25	4.7
Ag L α	2984.3	9.83e + 2	32.21	5.06	4.2
Ca K α	3691.7	5.57e + 2	32.16	3.55	3.4
Ti K α	4510.8	3.24e + 2	31.95	2.52	2.7
V K α	4952.2	2.51e + 2	31.82	2.15	2.5
Cr K α	5414.7	1.97e + 2	31.69	1.84	2.3
Mn K α	5898.8	1.56e + 2	31.56	1.59	2.1
Co K α	6930.3	1.00e + 2	31.28	1.20	1.8
Ni K α	7478.2	8.12e + 1	31.14	1.05	1.7
Cu K α	8047.8	6.62e + 1	30.98	0.92	1.5
Ge K α	9886.4	3.70e + 1	30.22	0.63	1.3
Y K α	14988.0	9.13e + 1	31.86	2.36	0.8
Mo K α	17479.0	6.03e + 1	32.18	1.82	0.7
Pd K α	21177.0	3.55e + 1	32.31	1.30	0.6
Sn K α	25271.0	2.16e + 1	32.32	0.94	0.5
Xe K α	29779.0	1.36e + 1	32.29	0.70	0.4

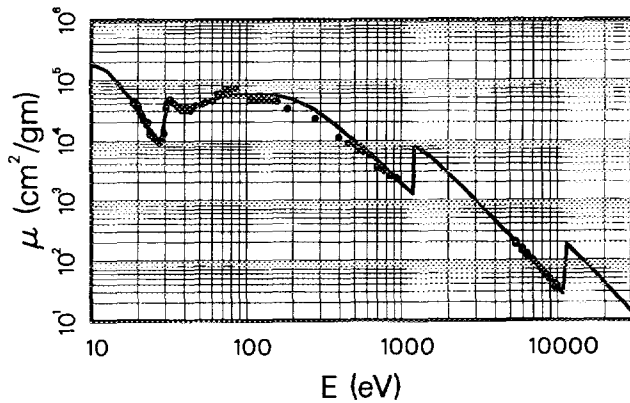
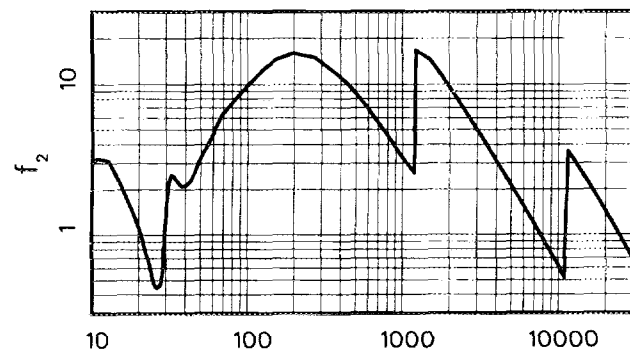
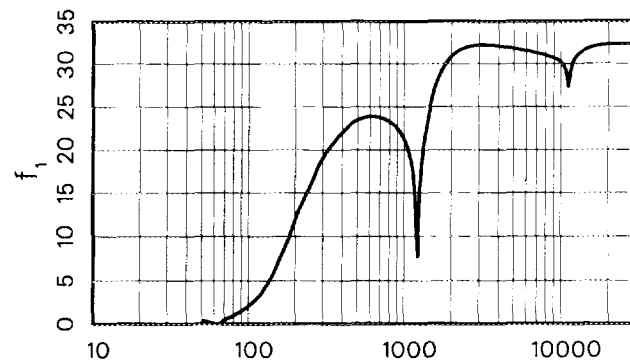

Edge Energies

K	11103.1 eV	L _I	1414.6 eV ^a	M _I	180.1 eV ^a
		L _{II}	1248.1 eV ^a	M _{II}	124.9 eV ^a
		L _{III}	1217.0 eV ^a	M _{III}	120.8 eV ^a
				M _{IV}	29.9 eV ^a
				M _V	29.3 eV ^a

References: 57, 61, 71, 99, 108, 133, 134, 142, 170.

TABLE I. Photoabsorption Cross Sections and Atomic Scattering Factors.

 $Z = 1-92$, $E = 50-30,000$ eV

See page 211 for Explanation of Tables

$$\mu_a(\text{barns/atom}) = \mu(\text{cm}^2/\text{gm}) \times 124.41$$

$$E(\text{keV})\mu(\text{cm}^2/\text{gm}) = f_2 \times 561.63$$

Arsenic (As)

 $Z = 33$

Atomic Weight = 74.922

Line	E(eV)	$\mu(\text{cm}^2/\text{gm})$	f_1	f_2	$\lambda(\text{\AA})$
H	10.2	2.58e+5		4.69	1215
He I	21.2	8.69e+4		3.28	584.3
Na L _{2,3}	30.5	1.56e+4		0.85	407.2
Mg L _{2,3}	49.3	1.77e+4		1.55	251.5
Al L _{2,3}	72.4	3.55e+4	2.84	4.57	171.2
Si L _{2,3}	91.5	4.38e+4	3.26	7.14	135.5
Be K	108.5	4.70e+4	4.21	9.09	114.3
Sr M ζ	114.0	4.76e+4	4.55	9.65	108.8
Y M ζ	132.8	4.84e+4	5.95	11.44	93.4
Zr M ζ	151.1	4.79e+4	7.69	12.89	82.1
B K α	183.3	4.39e+4	10.68	14.33	67.6
Mo M ζ	192.6	4.26e+4	11.59	14.60	64.4
Ar L ℓ	220.1	3.83e+4	14.49	15.00	56.3
C K α	277.0	2.78e+4	18.34	13.73	44.8
Ag M ζ	311.7	2.29e+4	19.91	12.72	39.8
N K α	392.4	1.56e+4	22.19	10.90	31.6
Ti L α	452.2	1.19e+4	23.27	9.56	27.4
V L α	511.3	9.28e+3	23.88	8.45	24.2
O K α	524.9	8.80e+3	23.98	8.22	23.6
Cr L α	572.8	7.33e+3	24.26	7.47	21.6
Mn L α	637.4	5.83e+3	24.44	6.61	19.5
F K α	676.8	5.09e+3	24.45	6.13	18.3
Fe L α	705.0	4.67e+3	24.43	5.87	17.6
Co L α	776.2	3.79e+3	24.34	5.23	16.0
Ni L α	851.5	3.07e+3	24.09	4.65	14.6
Cu L α	929.7	2.50e+3	23.67	4.15	13.3
Zn L α	1011.7	2.06e+3	23.04	3.70	12.3
Na K α	1041.0	1.92e+3	22.74	3.57	11.9
Ge L α	1188.0	1.41e+3	20.27	2.98	10.4
Mg K α	1253.6	1.24e+3	17.75	2.77	9.9
Al K α	1486.7	5.40e+3	22.37	14.29	8.3
Si K α	1740.0	4.26e+3	28.61	13.19	7.1
Zr L α	2042.4	2.87e+3	31.22	10.44	6.1
Mo L α	2293.2	2.14e+3	32.22	8.74	5.4
Cl K α	2622.4	1.51e+3	32.84	7.07	4.7
Ag L α	2984.3	1.08e+3	33.12	5.73	4.2
Ca K α	3691.7	6.12e+2	33.18	4.02	3.4
Ti K α	4510.8	3.56e+2	33.01	2.86	2.7
V K α	4952.2	2.77e+2	32.90	2.44	2.5
Cr K α	5414.7	2.17e+2	32.78	2.09	2.3
Mn K α	5898.8	1.72e+2	32.65	1.80	2.1
Co K α	6930.3	1.10e+2	32.39	1.36	1.8
Ni K α	7478.2	8.94e+1	32.26	1.19	1.7
Cu K α	8047.8	7.30e+1	32.12	1.05	1.5
Ge K α	9886.4	4.09e+1	31.54	0.72	1.3
Y K α	14988.0	9.85e+1	32.61	2.63	0.8
Mo K α	17479.0	6.53e+1	33.07	2.03	0.7
Pd K α	21177.0	3.86e+1	33.28	1.46	0.6
Sn K α	25271.0	2.36e+1	33.32	1.06	0.5
Xe K α	29779.0	1.48e+1	33.30	0.79	0.4

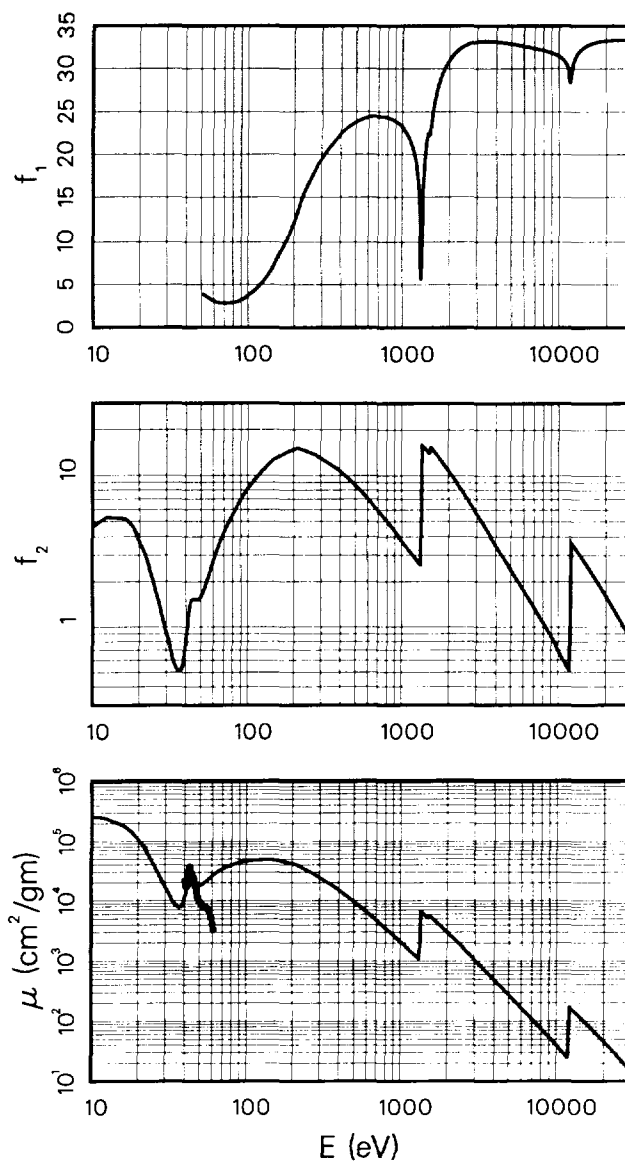

Edge Energies

K	11866.7 eV	L _I	1527.0 eV ^a	M _I	204.7 eV ^a
		L _{II}	1359.1 eV ^a	M _{II}	146.2 eV ^a
		L _{III}	1323.6 eV ^a	M _{III}	141.2 eV ^a
				M _{IV}	41.7 eV ^a
				M _V	41.7 eV ^a

References: 190.

TABLE I. Photoabsorption Cross Sections and Atomic Scattering Factors,
 $Z = 1-92$, $E = 50-30,000$ eV
 See page 211 for Explanation of Tables

μ_a (barns/atom) = μ (cm²/gm) \times 131.12
 E (keV) μ (cm²/gm) = $f_2 \times 532.91$

Selenium (Se)
 $Z = 34$
 Atomic Weight = 78.960

Line	E(eV)	μ (cm ² /gm)	f_1	f_2	λ (Å)
H	10.2	2.82e + 5		5.40	1215
He I	21.2	1.27e + 5		5.04	584.3
Na L _{2,3}	30.5	3.31e + 4		1.89	407.2
Mg L _{2,3}	49.3	5.39e + 3		0.50	251.5
Al L _{2,3}	72.4	1.80e + 4	3.12	2.45	171.2
Si L _{2,3}	91.5	3.04e + 4	2.03	5.23	135.5
Be K	108.5	3.93e + 4	2.39	7.99	114.3
Sr M ζ	114.0	4.12e + 4	2.63	8.80	108.8
Y M ζ	132.8	4.53e + 4	3.98	11.28	93.4
Zr M ζ	151.1	4.63e + 4	5.75	13.13	82.1
B K α	183.3	4.45e + 4	9.15	15.32	67.6
Mo M ζ	192.6	4.37e + 4	10.24	15.79	64.4
Ar L ℓ	220.1	3.88e + 4	13.25	16.03	56.3
C K α	277.0	3.01e + 4	17.70	15.63	44.8
Ag M ζ	311.7	2.49e + 4	19.81	14.54	39.8
N K α	392.4	1.70e + 4	22.65	12.49	31.6
Ti L α	452.2	1.30e + 4	24.00	10.99	27.4
V L α	511.3	1.01e + 4	24.78	9.73	24.2
O K α	524.9	9.63e + 3	24.92	9.48	23.6
Cr L α	572.8	8.04e + 3	25.32	8.64	21.6
Mn L α	637.4	6.40e + 3	25.63	7.66	19.5
F K α	676.8	5.59e + 3	25.71	7.10	18.3
Fe L α	705.0	5.14e + 3	25.73	6.80	17.6
Co L α	776.2	4.16e + 3	25.75	6.06	16.0
Ni L α	851.5	3.37e + 3	25.62	5.39	14.6
Cu L α	929.7	2.76e + 3	25.37	4.81	13.3
Zn L α	1011.7	2.26e + 3	24.96	4.29	12.3
Na K α	1041.0	2.11e + 3	24.77	4.13	11.9
Ge L α	1188.0	1.54e + 3	23.38	3.44	10.4
Mg K α	1253.6	1.36e + 3	22.35	3.19	9.9
Al K α	1486.7	5.62e + 3	18.18	15.67	8.3
Si K α	1740.0	4.46e + 3	27.29	14.56	7.1
Zr L α	2042.4	3.04e + 3	31.24	11.63	6.1
Mo L α	2293.2	2.27e + 3	32.66	9.79	5.4
Cl K α	2622.4	1.61e + 3	33.56	7.94	4.7
Ag L α	2984.3	1.15e + 3	34.01	6.45	4.2
Ca K α	3691.7	6.55e + 2	34.21	4.54	3.4
Ti K α	4510.8	3.82e + 2	34.10	3.23	2.7
V K α	4952.2	2.96e + 2	34.00	2.75	2.5
Cr K α	5414.7	2.32e + 2	33.89	2.36	2.3
Mn K α	5898.8	1.84e + 2	33.76	2.03	2.1
Co K α	6930.3	1.18e + 2	33.51	1.54	1.8
Ni K α	7478.2	9.58e + 1	33.39	1.34	1.7
Cu K α	8047.8	7.82e + 1	33.26	1.18	1.5
Ge K α	9886.4	4.39e + 1	32.78	0.82	1.3
Y K α	14988.0	1.03e + 2	33.31	2.88	0.8
Mo K α	17479.0	6.83e + 1	33.94	2.24	0.7
Pd K α	21177.0	4.05e + 1	34.23	1.61	0.6
Sn K α	25271.0	2.48e + 1	34.31	1.18	0.5
Xe K α	29779.0	1.57e + 1	34.30	0.88	0.4

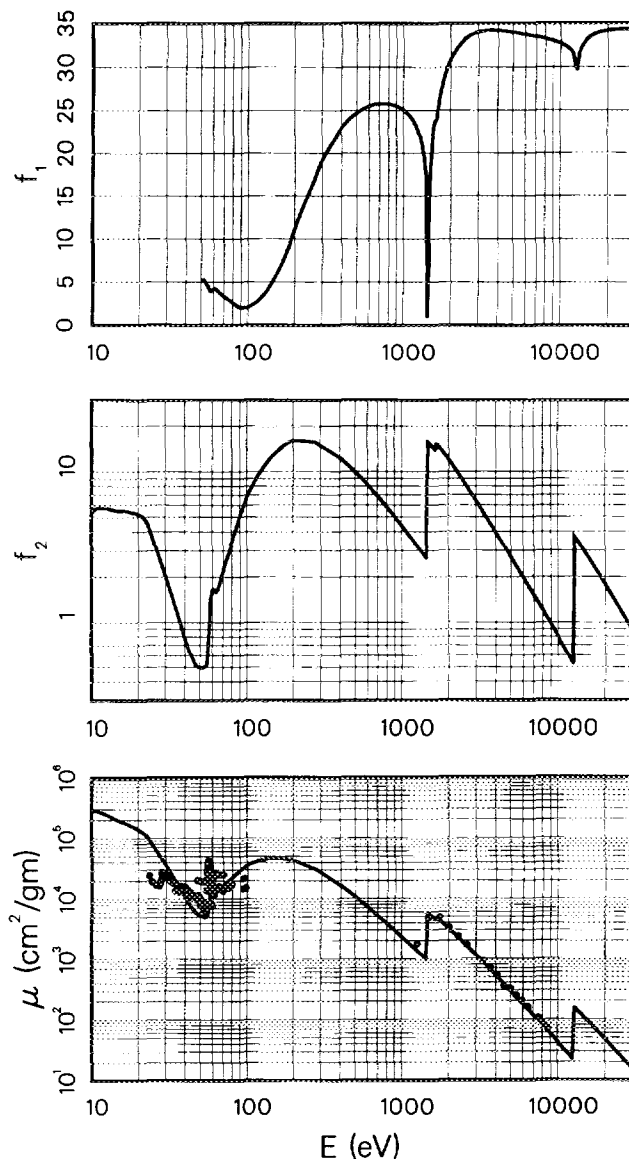

Edge Energies

K	12657.8 eV	L _I	1652.0 eV ^a	M _I	229.6 eV ^a
		L _{II}	1474.3 eV ^a	M _{II}	105.5 eV ^a
		L _{III}	1433.9 eV ^a	M _{III}	160.7 eV ^a
				M _{IV}	55.5 eV ^a
				M _V	54.6 eV ^a

References: 21, 25, 66, 171, 190.

TABLE I. Photoabsorption Cross Sections and Atomic Scattering Factors,
 $Z = 1-92$, $E = 50-30,000$ eV
 See page 211 for Explanation of Tables

μ_a (barns/atom) = μ (cm²/gm) \times 132.69
 E (keV) μ (cm²/gm) = $f_2 \times 526.61$

Bromine (Br)
 $Z = 35$
 Atomic Weight = 79.904

Line	E(eV)	μ (cm ² /gm)	f_1	f_2	λ (Å)
H	10.2	2.76e + 5		5.35	1215
He I	21.2	2.27e + 5		9.16	584.3
Na L _{2,3}	30.5	7.50e + 4		4.34	407.2
Mg L _{2,3}	49.3	7.14e + 3		0.67	251.5
Al L _{2,3}	72.4	1.32e + 4	5.18	1.82	171.2
Si L _{2,3}	91.5	1.74e + 4	3.44	3.01	135.5
Be K	108.5	2.77e + 4	2.62	5.70	114.3
Sr M ζ	114.0	3.00e + 4	2.69	6.49	108.8
Y M ζ	132.8	3.65e + 4	3.19	9.21	93.4
Zr M ζ	151.1	3.98e + 4	4.46	11.42	82.1
B K α	183.3	4.22e + 4	6.91	14.70	67.6
Mo M ζ	192.6	4.27e + 4	8.09	15.62	64.4
Ar L ℓ	220.1	3.99e + 4	11.41	16.69	56.3
C K α	277.0	3.24e + 4	16.77	17.03	44.8
Ag M ζ	311.7	2.70e + 4	19.32	15.98	39.8
N K α	392.4	1.87e + 4	22.78	13.95	31.6
Ti L α	452.2	1.43e + 4	24.46	12.32	27.4
V L α	511.3	1.13e + 4	25.45	10.95	24.2
O K α	524.9	1.07e + 4	25.63	10.67	23.6
Cr L α	572.8	8.95e + 3	26.14	9.74	21.6
Mn L α	637.4	7.16e + 3	26.59	8.67	19.5
F K α	676.8	6.27e + 3	26.73	8.05	18.3
Fe L α	705.0	5.76e + 3	26.80	7.72	17.6
Co L α	776.2	4.67e + 3	26.93	6.88	16.0
Ni L α	851.5	3.78e + 3	26.91	6.12	14.6
Cu L α	929.7	3.10e + 3	26.75	5.47	13.3
Zn L α	1011.7	2.55e + 3	26.49	4.91	12.3
Na K α	1041.0	2.39e + 3	26.37	4.72	11.9
Ge L α	1188.0	1.75e + 3	25.46	3.94	10.4
Mg K α	1253.6	1.54e + 3	24.86	3.66	9.9
Al K α	1486.7	1.02e + 3	18.97	2.89	8.3
Si K α	1740.0	4.27e + 3	24.70	14.11	7.1
Zr L α	2042.4	3.35e + 3	30.97	13.01	6.1
Mo L α	2293.2	2.51e + 3	32.97	10.95	5.4
Cl K α	2622.4	1.78e + 3	34.23	8.89	4.7
Ag L α	2984.3	1.27e + 3	34.86	7.22	4.2
Ca K α	3691.7	7.25e + 2	35.22	5.08	3.4
Ti K α	4510.8	4.23e + 2	35.17	3.62	2.7
V K α	4952.2	3.28e + 2	35.08	3.09	2.5
Cr K α	5414.7	2.58e + 2	34.98	2.65	2.3
Mn K α	5898.8	2.04e + 2	34.86	2.28	2.1
Co K α	6930.3	1.31e + 2	34.62	1.73	1.8
Ni K α	7478.2	1.06e + 2	34.50	1.51	1.7
Cu K α	8047.8	8.69e + 1	34.38	1.33	1.5
Ge K α	9886.4	4.89e + 1	33.96	0.92	1.3
Y K α	14988.0	1.12e + 2	33.76	3.18	0.8
Mo K α	17479.0	7.47e + 1	34.73	2.48	0.7
Pd K α	21177.0	4.46e + 1	35.16	1.79	0.6
Sn K α	25271.0	2.74e + 1	35.28	1.31	0.5
Xe K α	29779.0	1.73e + 1	35.30	0.98	0.4

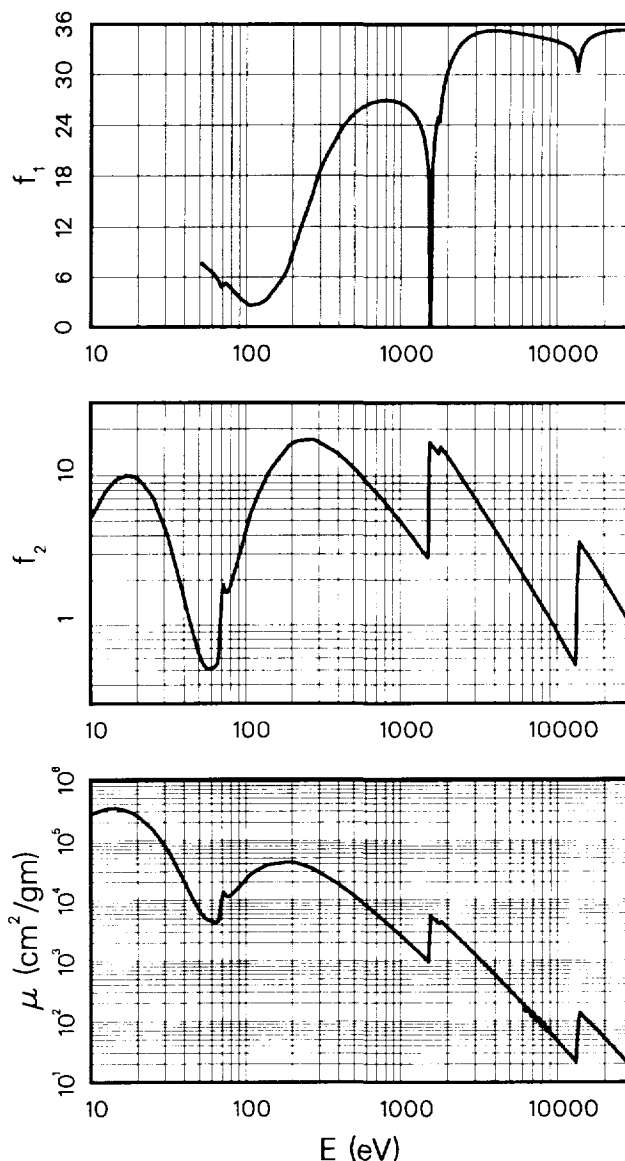

Edge Energies

K	13473.7 eV	L _I	1782.0 eV	M _I	257. eV*
		L _{II}	1596.0 eV	M _{II}	189. eV*
		L _{III}	1549.9 eV	M _{III}	183. eV*
				M _{IV}	70. eV*
				M _V	69. eV*

References: 29.

TABLE I. Photoabsorption Cross Sections and Atomic Scattering Factors.

Z = 1-92, E = 50-30,000 eV

See page 211 for Explanation of Tables

Krypton (Kr)

Z = 36

Atomic Weight = 83.800

$$\mu_a(\text{barns/atom}) = \mu(\text{cm}^2/\text{gm}) \times 139.16$$

$$E(\text{keV})\mu(\text{cm}^2/\text{gm}) = f_2 \times 502.13$$

Line	E(eV)	$\mu(\text{cm}^2/\text{gm})$	f_1	f_2	$\lambda(\text{\AA})$
H	10.2				1215
He I	21.2	2.59e + 5		10.95	584.3
Na L _{2,3}	30.5	1.14e + 5		6.94	407.2
Mg L _{2,3}	49.3	1.24e + 4		1.21	251.5
Al L _{2,3}	72.4	4.02e + 3	7.01	0.58	171.2
Si L _{2,3}	91.5	2.97e + 4	1.52	5.41	135.5
Be K	108.5	1.12e + 4	4.76	2.42	114.3
Sr M ζ	114.0	1.41e + 4	3.74	3.19	108.8
Y M ζ	132.8	2.53e + 4	2.55	6.68	93.4
Zr M ζ	151.1	3.23e + 4	3.25	9.72	82.1
B K α	183.3	3.66e + 4	5.78	13.35	67.6
Mo M ζ	192.6	3.70e + 4	6.55	14.17	64.4
Ar L ℓ	220.1	3.69e + 4	9.13	16.17	56.3
C K α	277.0	3.19e + 4	15.15	17.58	44.8
Ag M ζ	311.7	2.76e + 4	17.58	17.12	39.8
N K α	392.4	2.08e + 4	21.96	16.25	31.6
Ti L α	452.2	1.62e + 4	24.50	14.55	27.4
V L α	511.3	1.29e + 4	25.97	13.13	24.2
O K α	524.9	1.23e + 4	26.27	12.84	23.6
Cr L α	572.8	1.02e + 4	27.13	11.69	21.6
Mn L α	637.4	8.17e + 3	27.79	10.37	19.5
F K α	676.8	7.19e + 3	28.05	9.70	18.3
Fe L α	705.0	6.61e + 3	28.20	9.28	17.6
Co L α	776.2	5.41e + 3	28.53	8.36	16.0
Ni L α	851.5	4.36e + 3	28.82	7.39	14.6
Cu L α	929.7	3.46e + 3	28.72	6.41	13.3
Zn L α	1011.7	2.84e + 3	28.50	5.71	12.3
Na K α	1041.0	2.65e + 3	28.41	5.50	11.9
Ge L α	1188.0	1.94e + 3	27.80	4.59	10.4
Mg K α	1253.6	1.71e + 3	27.41	4.26	9.9
Al K α	1486.7	1.13e + 3	24.92	3.35	8.3
Si K α	1740.0	4.30e + 3	22.02	14.91	7.1
Zr L α	2042.4	3.38e + 3	30.12	13.76	6.1
Mo L α	2293.2	2.56e + 3	32.97	11.69	5.4
Cl K α	2622.4	1.83e + 3	34.68	9.57	4.7
Ag L α	2984.3	1.31e + 3	35.56	7.81	4.2
Ca K α	3691.7	7.50e + 2	36.14	5.52	3.4
Ti K α	4510.8	4.37e + 2	36.19	3.93	2.7
V K α	4952.2	3.39e + 2	36.12	3.34	2.5
Cr K α	5414.7	2.66e + 2	36.03	2.86	2.3
Mn K α	5898.8	2.10e + 2	35.91	2.47	2.1
Co K α	6930.3	1.35e + 2	35.68	1.86	1.8
Ni K α	7478.2	1.09e + 2	35.56	1.62	1.7
Cu K α	8047.8	8.91e + 1	35.44	1.43	1.5
Ge K α	9886.4	5.05e + 1	35.04	0.99	1.3
Y K α	14988.0	1.17e + 2	33.73	3.50	0.8
Mo K α	17479.0	7.86e + 1	35.45	2.74	0.7
Pd K α	21177.0	4.70e + 1	36.06	1.98	0.6
Sr K α	25271.0	2.90e + 1	36.24	1.46	0.5
Xe K α	29779.0	1.83e + 1	36.29	1.09	0.4

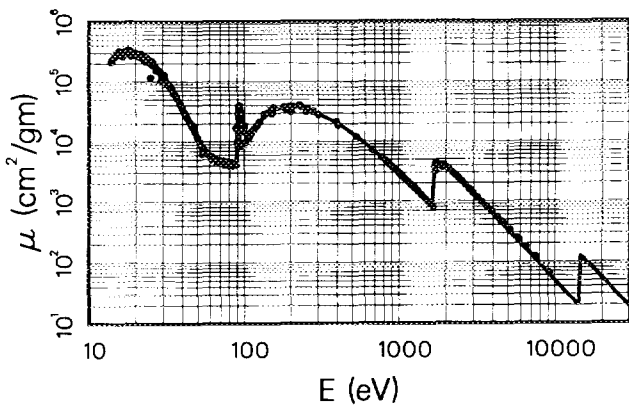
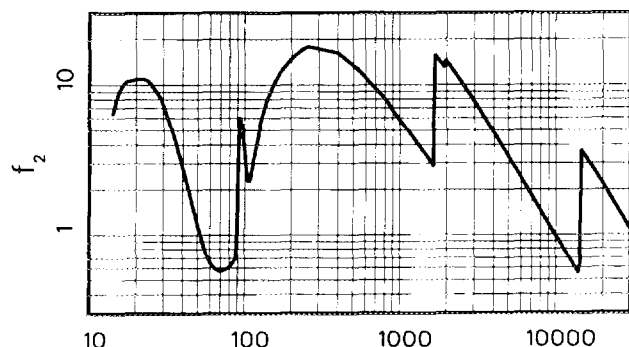
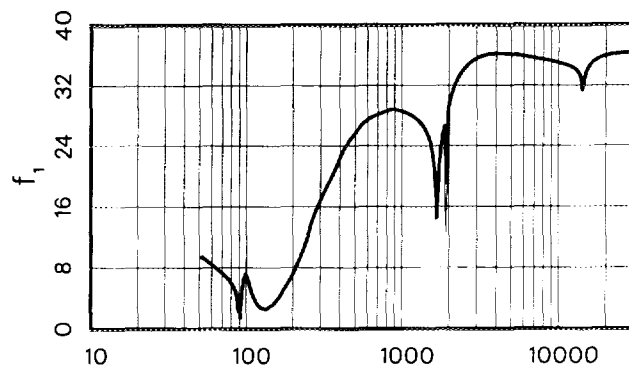

Edge Energies

K	14325.6 eV	L _I	1921.0 eV	M _I	292.8 eV ^a	N _I	27.5 eV ^a
		L _{II}	1730.9 eV ^a	M _{II}	222.2 eV ^a	N _{II}	14.1 eV ^a
		L _{III}	1678.4 eV ^a	M _{III}	214.4 eV ^a	N _{III}	14.1 eV ^a
				M _{IV}	95.0 eV ^a		
				M _V	93.8 eV ^a		

References: 11, 55, 82, 111, 137, 140, 141, 151, 186, 194, 218.

TABLE I. Photoabsorption Cross Sections and Atomic Scattering Factors,
 $Z = 1-92$, $E = 50-30,000$ eV
 See page 211 for Explanation of Tables

Rubidium (Rb)
 $Z = 37$
 Atomic Weight = 85.468

$\mu_a(\text{barns/atom}) = \mu(\text{cm}^2/\text{gm}) \times 141.92$
 $E(\text{keV})\mu(\text{cm}^2/\text{gm}) = f_2 \times 492.33$

Line	E(eV)	$\mu(\text{cm}^2/\text{gm})$	f_1	f_2	$\lambda(\text{\AA})$
H	10.2	3.45e + 3		0.07	1215
He I	21.2	4.06e + 5		17.52	584.3
Na L _{2,3}	30.5	2.58e + 5		15.97	407.2
Mg L _{2,3}	49.3	1.96e + 4		1.96	251.5
Al L _{2,3}	72.4	4.54e + 3	8.82	0.67	171.2
Si L _{2,3}	91.5	4.40e + 3	6.90	0.82	135.5
Be K	108.5	8.52e + 3	4.42	1.88	114.3
Sr M ζ	114.0	1.16e + 4	4.65	2.67	108.8
Y M ζ	132.8	1.80e + 4	2.23	4.85	93.4
Zr M ζ	151.1	2.68e + 4	1.99	8.24	82.1
B K α	183.3	3.64e + 4	3.74	13.55	67.6
Mo M ζ	192.6	3.77e + 4	4.80	14.73	64.4
Ar L l	220.1	3.88e + 4	7.77	17.34	56.3
C K α	277.0	3.40e + 4	13.98	19.15	44.8
Ag M ζ	311.7	3.07e + 4	17.34	19.46	39.8
N K α	392.4	2.19e + 4	22.82	17.45	31.6
Ti L α	452.2	1.70e + 4	25.37	15.62	27.4
V L α	511.3	1.35e + 4	26.92	13.99	24.2
O K α	524.9	1.28e + 4	27.21	13.65	23.6
Cr L α	572.8	1.07e + 4	28.05	12.49	21.6
Mn L α	637.4	8.61e + 3	28.81	11.15	19.5
F K α	676.8	7.56e + 3	29.10	10.39	18.3
Fe L α	705.0	6.97e + 3	29.27	9.97	17.6
Co L α	776.2	5.67e + 3	29.64	8.94	16.0
Ni L α	851.5	4.61e + 3	29.84	7.97	14.6
Cu L α	929.7	3.77e + 3	29.91	7.13	13.3
Zn L α	1011.7	3.10e + 3	29.85	6.38	12.3
Na K α	1041.0	2.91e + 3	29.81	6.15	11.9
Ge L α	1188.0	2.14e + 3	29.45	5.16	10.4
Mg K α	1253.6	1.88e + 3	29.22	4.80	9.9
Al K α	1486.7	1.25e + 3	27.82	3.77	8.3
Si K α	1740.0	8.28e + 2	22.71	2.93	7.1
Zr L α	2042.4	3.32e + 3	27.62	13.76	6.1
Mo L α	2293.2	2.75e + 3	32.35	12.82	5.4
Cl K α	2622.4	1.98e + 3	34.84	10.56	4.7
Ag L α	2984.3	1.43e + 3	36.10	8.67	4.2
Ca K α	3691.7	8.20e + 2	37.01	6.15	3.4
Ti K α	4510.8	4.79e + 2	37.19	4.39	2.7
V K α	4952.2	3.72e + 2	37.16	3.74	2.5
Cr K α	5414.7	2.92e + 2	37.09	3.21	2.3
Mn K α	5898.8	2.31e + 2	36.99	2.76	2.1
Co K α	6930.3	1.48e + 2	36.78	2.08	1.8
Ni K α	7478.2	1.20e + 2	36.67	1.82	1.7
Cu K α	8047.8	9.79e + 1	36.55	1.60	1.5
Ge K α	9886.4	5.55e + 1	36.18	1.11	1.3
Y K α	14988.0	1.78e + 1	32.94	0.54	0.8
Mo K α	17479.0	8.42e + 1	36.07	2.99	0.7
Pd K α	21177.0	5.08e + 1	36.93	2.18	0.6
Sn K α	25271.0	3.14e + 1	37.19	1.61	0.5
Xe K α	29779.0	1.99e + 1	37.27	1.21	0.4

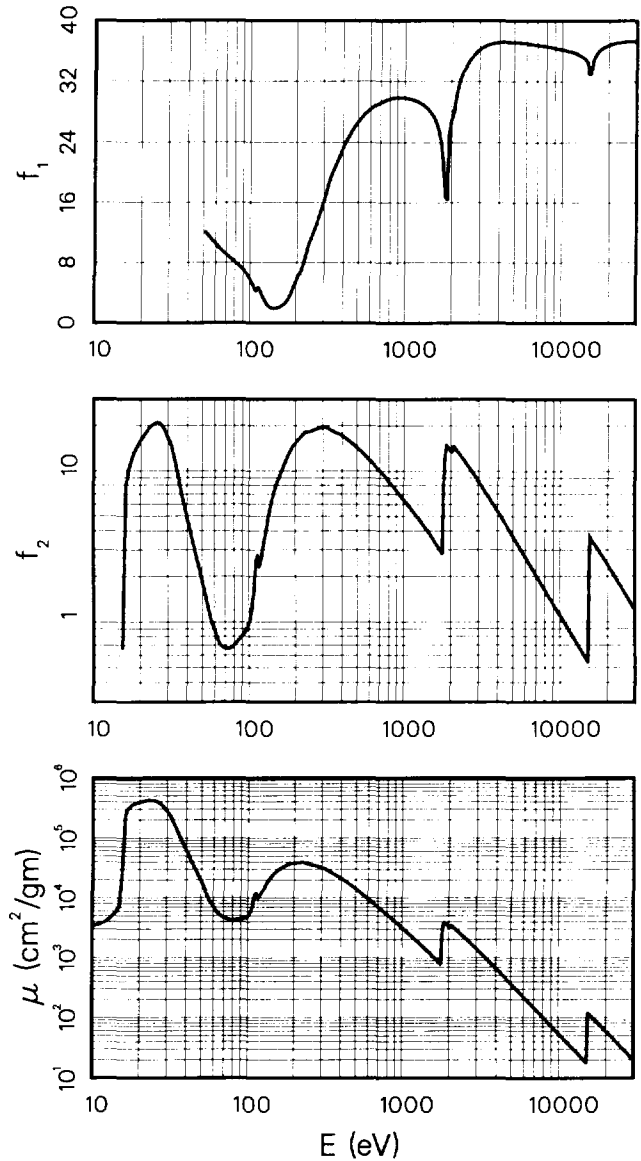

Edge Energies

K	15199.7 eV	L _I	2065.1 eV	M _I	326.7 eV ^a	N _I	30.5 eV ^a
		L _{II}	1863.9 eV	M _{II}	248.7 eV ^a	N _{II}	16.3 eV ^a
		L _{III}	1804.4 eV	M _{III}	239.1 eV ^a	N _{III}	15.3 eV ^a
				M _{IV}	113.0 eV ^a		
				M _V	112.0 eV ^a		

TABLE I. Photoabsorption Cross Sections and Atomic Scattering Factors,
 $Z = 1-92$, $E = 50-30,000$ eV
 See page 211 for Explanation of Tables

Strontium (Sr)
 $Z = 38$

Atomic Weight = 87.620

μ_a (barns/atom) = μ (cm²/gm) \times 145.50
 E (keV) μ (cm²/gm) = $f_2 \times 480.24$

Line	E(eV)	μ (cm ² /gm)	f_1	f_2	λ (Å)
H	10.2	8.27e + 3		0.18	1215
He I	21.2	2.22e + 4		0.98	584.3
Na L _{2,3}	30.5	2.99e + 5		18.98	407.2
Mg L _{2,3}	49.3	3.60e + 4		3.70	251.5
Al L _{2,3}	72.4	5.55e + 3	10.41	0.84	171.2
Si L _{2,3}	91.5	4.90e + 3	8.68	0.93	135.5
Be K	108.5	4.85e + 3	7.39	1.10	114.3
Sr M ζ	114.0	4.84e + 3	6.89	1.15	108.8
Y M ζ	132.8	7.95e + 3	4.54	2.20	93.4
Zr M ζ	151.1	1.50e + 4	2.12	4.73	82.1
B K α	183.3	2.89e + 4	2.58	11.04	67.6
Mo M ζ	192.6	3.10e + 4	3.24	12.42	64.4
Ar L ℓ	220.1	3.44e + 4	5.73	15.77	56.3
C K α	277.0	3.50e + 4	11.99	20.16	44.8
Ag M ζ	311.7	3.07e + 4	16.21	19.91	39.8
N K α	392.4	2.32e + 4	21.98	18.96	31.6
Ti L α	452.2	1.81e + 4	25.10	17.07	27.4
V L α	511.3	1.44e + 4	26.95	15.37	24.2
O K α	524.9	1.37e + 4	27.30	15.02	23.6
Cr L α	572.8	1.16e + 4	28.32	13.82	21.6
Mn L α	637.4	9.35e + 3	29.29	12.40	19.5
F K α	676.8	8.22e + 3	29.69	11.58	18.3
Fe L α	705.0	7.58e + 3	29.92	11.13	17.6
Co L α	776.2	6.17e + 3	30.43	9.97	16.0
Ni L α	851.5	5.02e + 3	30.72	8.91	14.6
Cu L α	929.7	4.13e + 3	30.87	7.99	13.3
Zn L α	1011.7	3.40e + 3	30.91	7.17	12.3
Na K α	1041.0	3.19e + 3	30.90	6.91	11.9
Ge L α	1188.0	2.34e + 3	30.68	5.80	10.4
Mg K α	1253.6	2.07e + 3	30.52	5.40	9.9
Al K α	1486.7	1.37e + 3	29.52	4.25	8.3
Si K α	1740.0	9.43e + 2	27.13	3.42	7.1
Zr L α	2042.4	3.47e + 3	23.58	14.78	6.1
Mo L α	2293.2	3.03e + 3	30.81	14.49	5.4
Cl K α	2622.4	2.18e + 3	34.87	11.89	4.7
Ag L α	2984.3	1.57e + 3	36.62	9.75	4.2
Ca K α	3691.7	9.01e + 2	37.87	6.93	3.4
Ti K α	4510.8	5.29e + 2	38.19	4.97	2.7
V K α	4952.2	4.12e + 2	38.19	4.25	2.5
Cr K α	5414.7	3.24e + 2	38.15	3.65	2.3
Mn K α	5898.8	2.57e + 2	38.08	3.15	2.1
Co K α	6930.3	1.66e + 2	37.89	2.39	1.8
Ni K α	7478.2	1.35e + 2	37.78	2.10	1.7
Cu K α	8047.8	1.10e + 2	37.68	1.85	1.5
Ge K α	9886.4	6.24e + 1	37.35	1.28	1.3
Y K α	14988.0	1.94e + 1	35.86	0.61	0.8
Mo K α	17479.0	8.99e + 1	36.37	3.27	0.7
Pd K α	21177.0	5.44e + 1	37.75	2.40	0.6
Sn K α	25271.0	3.38e + 1	38.12	1.78	0.5
Xe K α	29779.0	2.15e + 1	38.25	1.33	0.4

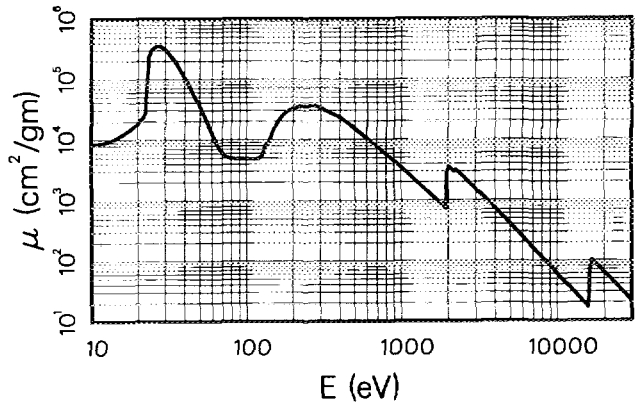
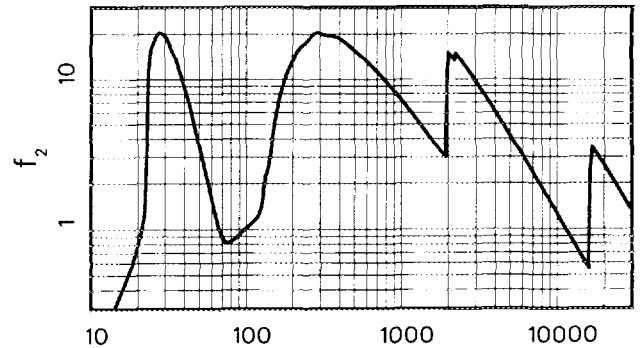
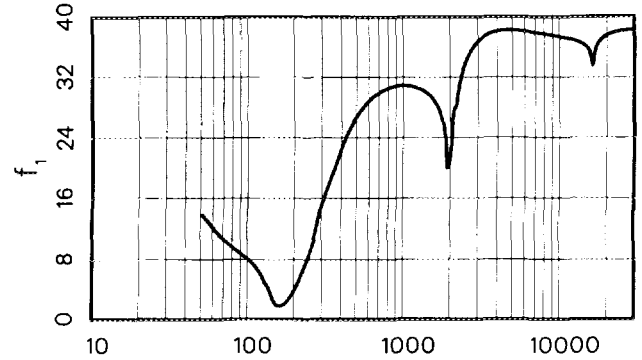

Edge Energies

K	16104.6 eV	L _I	2216.3 eV	M _I	358.7 eV ^b	N _I	38.9 eV ^b
		L _{II}	2006.8 eV	M _{II}	280.3 eV ^b	N _{II}	21.6 eV ^b
		L _{III}	1939.6 eV	M _{III}	270.0 eV ^b	N _{III}	20.3 eV ^b
				M _{IV}	136.0 eV ^b		
				M _V	134.2 eV ^b		

TABLE I. Photoabsorption Cross Sections and Atomic Scattering Factors,
 $Z = 1-92$, $E = 50-30,000$ eV
 See page 211 for Explanation of Tables

$\mu_a(\text{barns/atom}) = \mu(\text{cm}^2/\text{gm}) \times 147.63$
 $E(\text{keV})\mu(\text{cm}^2/\text{gm}) = f_2 \times 473.29$

Yttrium (Y)
 $Z = 39$
 Atomic Weight = 88.906

Line	E(eV)	$\mu(\text{cm}^2/\text{gm})$	f_1	f_2	$\lambda(\text{\AA})$
H	10.2	9.06e+4		1.95	1215
He I	21.2	2.12e+4		0.95	584.3
Na L _{2,3}	30.5	2.75e+5		17.67	407.2
Mg L _{2,3}	49.3	5.03e+4		5.24	251.5
Al L _{2,3}	72.4	6.52e+3	12.44	1.00	171.2
Si L _{2,3}	91.5	4.76e+3	10.67	0.92	135.5
Be K	108.5	4.91e+3	9.63	1.13	114.3
Sr M ζ	114.0	4.91e+3	9.30	1.18	108.8
Y M ζ	132.8	5.09e+3	7.94	1.43	93.4
Zr M ζ	151.1	6.91e+3	6.05	2.21	82.1
B K α	183.3	1.92e+4	2.47	7.43	67.6
Mo M ζ	192.6	2.35e+4	2.91	9.58	64.4
Ar L ℓ	220.1	2.85e+4	5.28	13.24	56.3
C K α	277.0	3.05e+4	9.86	17.84	44.8
Ag M ζ	311.7	3.01e+4	13.09	19.83	39.8
N K α	392.4	2.55e+4	21.06	21.16	31.6
Ti L α	452.2	1.97e+4	25.53	18.78	27.4
V L α	511.3	1.55e+4	27.59	16.75	24.2
O K α	524.9	1.48e+4	27.97	16.36	23.6
Cr L α	572.8	1.25e+4	29.11	15.08	21.6
Mn L α	637.4	1.01e+4	30.28	13.63	19.5
F K α	676.8	8.93e+3	30.93	12.77	18.3
Fe L α	705.0	8.15e+3	31.25	12.13	17.6
Co L α	776.2	6.56e+3	31.79	10.76	16.0
Ni L α	851.5	5.33e+3	32.13	9.59	14.6
Cu L α	929.7	4.36e+3	32.37	8.57	13.3
Zn L α	1011.7	3.56e+3	32.44	7.61	12.3
Na K α	1041.0	3.32e+3	32.43	7.31	11.9
Ge L α	1188.0	2.43e+3	32.22	6.10	10.4
Mg K α	1253.6	2.14e+3	32.08	5.67	9.9
Al K α	1486.7	1.43e+3	31.32	4.49	8.3
Si K α	1740.0	1.00e+3	29.87	3.68	7.1
Zr L α	2042.4	1.04e+3	23.11	4.50	6.1
Mo L α	2293.2	2.72e+3	29.03	13.20	5.4
Cl K α	2622.4	2.26e+3	34.09	12.52	4.7
Ag L α	2984.3	1.66e+3	36.74	10.46	4.2
Ca K α	3691.7	9.55e+2	38.41	7.45	3.4
Ti K α	4510.8	5.70e+2	38.87	5.44	2.7
V K α	4952.2	4.51e+2	38.99	4.72	2.5
Cr K α	5414.7	3.56e+2	39.03	4.08	2.3
Mn K α	5898.8	2.84e+2	39.01	3.54	2.1
Co K α	6930.3	1.85e+2	38.89	2.71	1.8
Ni K α	7478.2	1.51e+2	38.80	2.38	1.7
Cu K α	8047.8	1.24e+2	38.73	2.11	1.5
Ge K α	9886.4	6.81e+1	38.43	1.42	1.3
Y K α	14988.0	2.13e+1	37.20	0.67	0.8
Mo K α	17479.0	9.60e+1	36.24	3.55	0.7
Pd K α	21177.0	5.86e+1	38.57	2.62	0.6
Sn K α	25271.0	3.65e+1	39.06	1.95	0.5
Xe K α	29779.0	2.33e+1	39.22	1.47	0.4

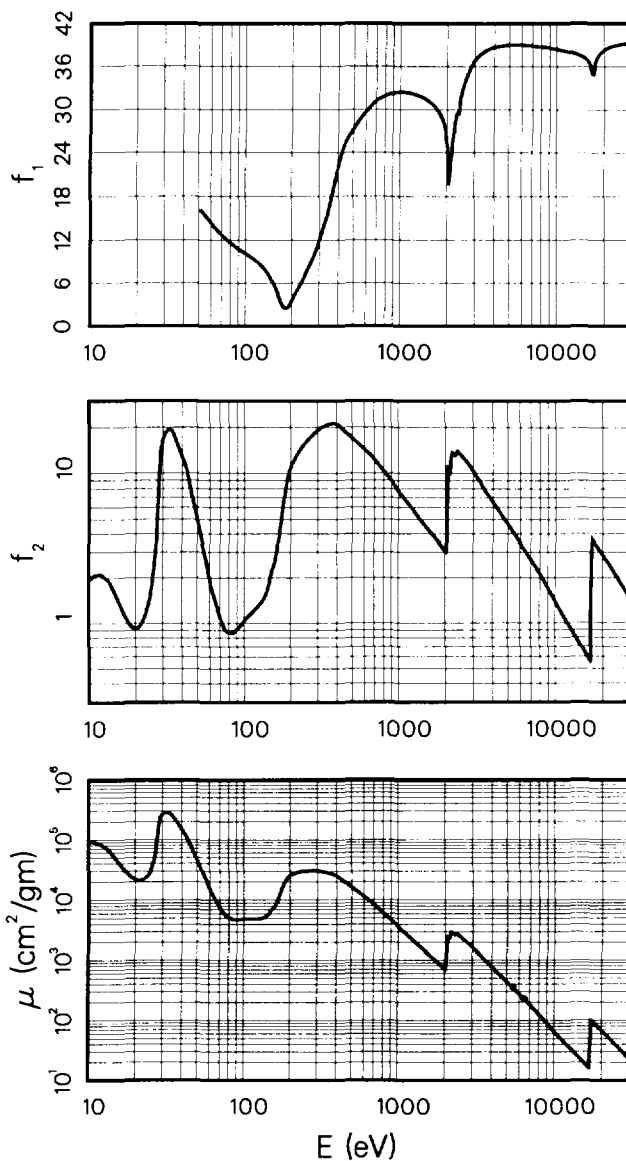

Edge Energies

K	17038.4 eV	L _I	2372.5 eV	M _I	392.0 eV ^a	N _I	43.8 eV ^a
		L _{II}	2155.5 eV	M _{II}	310.6 eV ^a	N _{II}	24.4 eV ^a
		L _{III}	2080.0 eV	M _{III}	298.8 eV ^a	N _{III}	23.1 eV ^a
				M _{IV}	157.7 eV ^a		
				M _V	155.8 eV ^a		

References: 222.

TABLE I. Photoabsorption Cross Sections and Atomic Scattering Factors,
 $Z = 1-92$, $E = 50-30,000$ eV
 See page 211 for Explanation of Tables

μ_a (barns/atom) = μ (cm²/gm) \times 151.48
 E (keV) μ (cm²/gm) = $f_2 \times 461.26$

Zirconium (Zr)
 $Z = 40$
 Atomic Weight = 91.224

Line	E(eV)	μ (cm ² /gm)	f_1	f_2	λ (Å)
H	10.2	1.95e + 5		4.31	1215
He I	21.2	7.52e + 4		3.46	584.3
Na L _{2,3}	30.5	9.80e + 4		6.47	407.2
Mg L _{2,3}	49.3	8.19e + 4		8.75	251.5
Al L _{2,3}	72.4	1.09e + 4	14.04	1.72	171.2
Si L _{2,3}	91.5	5.34e + 3	12.11	1.06	135.5
Be K	108.5	5.03e + 3	10.95	1.18	114.3
Sr M ζ	114.0	5.13e + 3	10.66	1.27	108.8
Y M ζ	132.8	5.27e + 3	9.74	1.52	93.4
Zr M ζ	151.1	5.36e + 3	8.63	1.76	82.1
B K α	183.3	7.24e + 3	5.16	2.88	67.6
Mo M ζ	192.6	1.03e + 4	3.60	4.29	64.4
Ar L ℓ	220.1	2.24e + 4	3.53	10.67	56.3
C K α	277.0	2.71e + 4	8.56	16.27	44.8
Ag M ζ	311.7	2.71e + 4	11.41	18.34	39.8
N K α	392.4	2.35e + 4	18.14	20.00	31.6
Ti L α	452.2	1.99e + 4	21.94	19.48	27.4
V L α	511.3	1.71e + 4	24.75	18.98	24.2
O K α	524.9	1.66e + 4	25.45	18.84	23.6
Cr L α	572.8	1.43e + 4	27.54	17.78	21.6
Mn L α	637.4	1.19e + 4	29.65	16.43	19.5
F K α	676.8	1.05e + 4	30.70	15.37	18.3
Fe L α	705.0	9.59e + 3	31.23	14.65	17.6
Co L α	776.2	7.79e + 3	32.22	13.11	16.0
Ni L α	851.5	6.34e + 3	33.18	11.70	14.6
Cu L α	929.7	4.91e + 3	33.54	9.89	13.3
Zn L α	1011.7	4.03e + 3	33.20	8.84	12.3
Na K α	1041.0	3.82e + 3	33.21	8.63	11.9
Ge L α	1188.0	2.84e + 3	33.32	7.30	10.4
Mg K α	1253.6	2.50e + 3	33.27	6.80	9.9
Al K α	1486.7	1.67e + 3	32.77	5.38	8.3
Si K α	1740.0	1.15e + 3	31.73	4.32	7.1
Zr L α	2042.4	7.77e + 2	28.88	3.44	6.1
Mo L α	2293.2	2.70e + 3	23.36	13.44	5.4
Cl K α	2622.4	2.50e + 3	33.06	14.20	4.7
Ag L α	2984.3	1.82e + 3	36.88	11.77	4.2
Ca K α	3691.7	1.06e + 3	39.28	8.46	3.4
Ti K α	4510.8	6.25e + 2	40.05	6.11	2.7
V K α	4952.2	4.87e + 2	40.17	5.23	2.5
Cr K α	5414.7	3.83e + 2	40.20	4.50	2.3
Mn K α	5898.8	3.04e + 2	40.18	3.89	2.1
Co K α	6930.3	1.96e + 2	40.04	2.95	1.8
Ni K α	7478.2	1.60e + 2	39.95	2.59	1.7
Cu K α	8047.8	1.31e + 2	39.85	2.28	1.5
Ge K α	9886.4	7.40e + 1	39.55	1.59	1.3
Y K α	14988.0	2.31e + 1	38.55	0.75	0.8
Mo K α	17479.0	1.51e + 1	36.91	0.57	0.7
Pd K α	21177.0	6.22e + 1	39.26	2.86	0.6
Sn K α	25271.0	3.88e + 1	39.94	2.13	0.5
Xe K α	29779.0	2.48e + 1	40.17	1.60	0.4

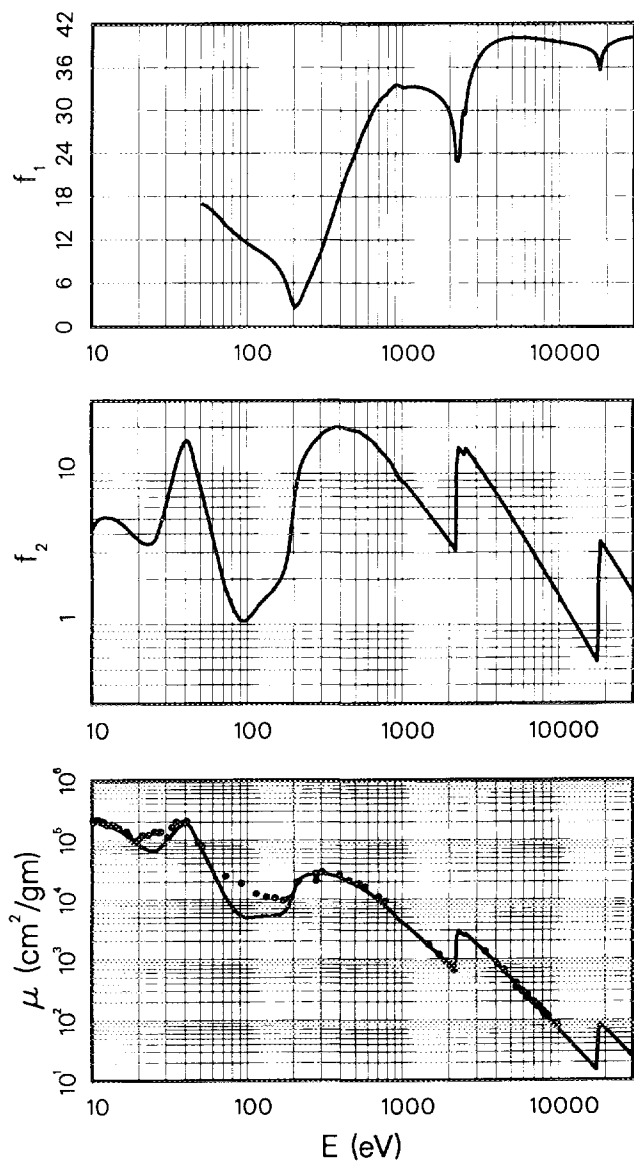

Edge Energies

K	17997.6 eV	L _I	2531.6 eV	M _I	430.3 eV ^b	N _I	50.6 eV ^b
		L _{II}	2306.7 eV	M _{II}	343.5 eV ^b	N _{II}	28.5 eV ^b
		L _{III}	2222.3 eV	M _{III}	329.8 eV ^b	N _{III}	27.1 eV ^b
				M _{IV}	181.1 eV ^b		
				M _V	178.8 eV ^b		

References: 33, 52, 59, 76, 99, 115, 123, 127, 131, 175, 200, 201, 203, 232.

TABLE I. Photoabsorption Cross Sections and Atomic Scattering Factors,
 $Z = 1-92$, $E = 50-30,000$ eV
 See page 211 for Explanation of Tables

$\mu_a(\text{barns/atom}) = \mu(\text{cm}^2/\text{gm}) \times 154.28$
 $E(\text{keV})\mu(\text{cm}^2/\text{gm}) = f_2 \times 452.91$

Niobium (Nb)
 $Z = 41$
 Atomic Weight = 92.906

Line	E(eV)	$\mu(\text{cm}^2/\text{gm})$	f_1	f_2	$\lambda(\text{\AA})$
H	10.2	1.19e+5		2.68	1215
He I	21.2	9.18e+4		4.30	584.3
Na L _{2,3}	30.5	5.42e+4		3.65	407.2
Mg L _{2,3}	49.3	1.30e+5		14.15	251.5
Al L _{2,3}	72.4	1.98e+4	17.21	3.16	171.2
Si L _{2,3}	91.5	5.72e+3	14.63	1.15	135.5
Be K	108.5	4.86e+3	13.06	1.16	114.3
Sr M ζ	114.0	5.05e+3	12.74	1.27	108.8
Y M ζ	132.8	5.44e+3	11.88	1.59	93.4
Zr M ζ	151.1	5.57e+3	11.14	1.86	82.1
B K α	183.3	5.47e+3	9.25	2.21	67.6
Mo M ζ	192.6	5.73e+3	8.36	2.44	64.4
Ar L ℓ	220.1	1.05e+4	4.50	5.08	56.3
C K α	277.0	2.47e+4	7.89	15.08	44.8
Ag M ζ	311.7	2.52e+4	11.22	17.35	39.8
N K α	392.4	2.22e+4	17.22	19.27	31.6
Ti L α	452.2	1.95e+4	21.24	19.49	27.4
V L α	511.3	1.67e+4	24.38	18.90	24.2
O K α	524.9	1.62e+4	25.02	18.76	23.6
Cr L α	572.8	1.41e+4	27.19	17.85	21.6
Mn L α	637.4	1.17e+4	29.08	16.47	19.5
F K α	676.8	1.05e+4	29.97	15.74	18.3
Fe L α	705.0	9.81e+3	30.54	15.27	17.6
Co L α	776.2	8.22e+3	31.86	14.09	16.0
Ni L α	851.5	6.84e+3	33.06	12.86	14.6
Cu L α	929.7	5.50e+3	33.73	11.29	13.3
Zn L α	1011.7	4.55e+3	34.05	10.16	12.3
Na K α	1041.0	4.26e+3	34.15	9.79	11.9
Ge L α	1188.0	3.14e+3	34.38	8.23	10.4
Mg K α	1253.6	2.77e+3	34.39	7.66	9.9
Al K α	1486.7	1.85e+3	34.17	6.06	8.3
Si K α	1740.0	1.24e+3	33.42	4.78	7.1
Zr L α	2042.4	8.37e+2	31.60	3.77	6.1
Mo L α	2293.2	6.34e+2	27.13	3.21	5.4
Cl K α	2622.4	2.34e+3	31.16	13.57	4.7
Ag L α	2984.3	1.95e+3	36.48	12.88	4.2
Ca K α	3691.7	1.14e+3	39.83	9.31	3.4
Ti K α	4510.8	6.77e+2	40.91	6.74	2.7
V K α	4952.2	5.28e+2	41.11	5.77	2.5
Cr K α	5414.7	4.15e+2	41.19	4.96	2.3
Mn K α	5898.8	3.29e+2	41.20	4.29	2.1
Co K α	6930.3	2.12e+2	41.09	3.25	1.8
Ni K α	7478.2	1.72e+2	41.02	2.85	1.7
Cu K α	8047.8	1.41e+2	40.93	2.51	1.5
Ge K α	9886.4	7.97e+1	40.64	1.74	1.3
Y K α	14988.0	2.48e+1	39.71	0.82	0.8
Mo K α	17479.0	1.62e+1	38.86	0.63	0.7
Pd K α	21177.0	6.62e+1	39.88	3.10	0.6
Sn K α	25271.0	4.15e+1	40.82	2.31	0.5
Xe K α	29779.0	2.66e+1	41.12	1.75	0.4

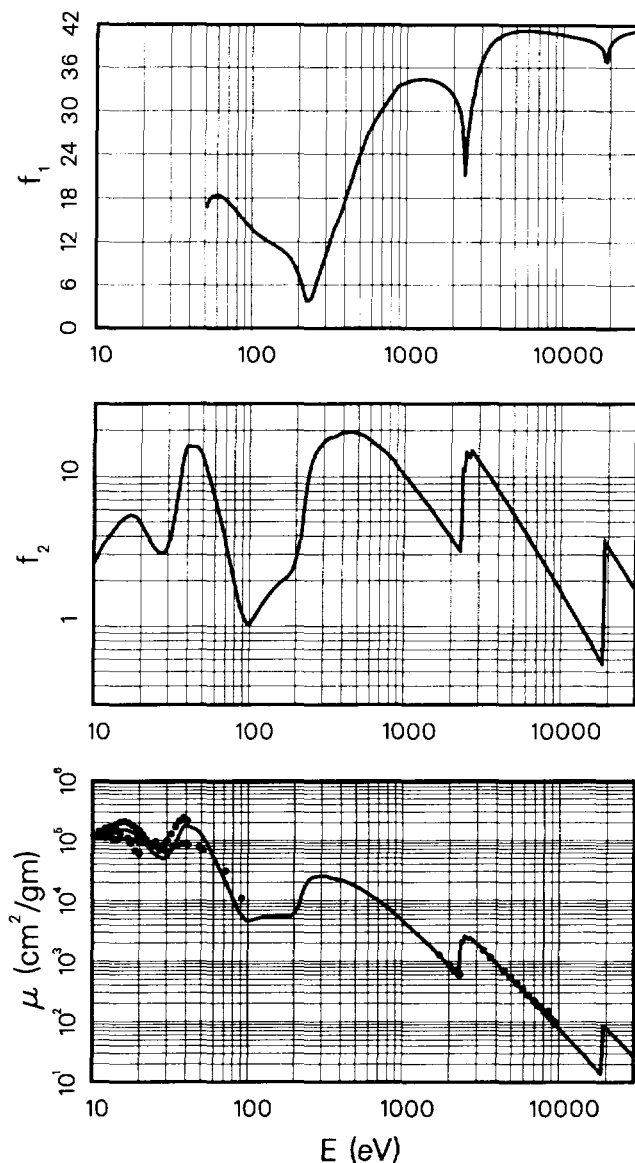

Edge Energies

K	18985.6 eV	L _I	2697.7 eV	M _I	466.6 eV ^b	N _I	56.4 eV ^b
		L _{II}	2464.7 eV	M _{II}	376.1 eV ^b	N _{II}	32.6 eV ^b
		L _{III}	2370.5 eV	M _{III}	360.6 eV ^b	N _{III}	30.8 eV ^b
				M _{IV}	205.0 eV ^b		
				M _V	202.3 eV ^b		

References: 59, 98, 99, 123, 175, 211, 223, 232.

TABLE I. Photoabsorption Cross Sections and Atomic Scattering Factors,
 $Z = 1-92$, $E = 50-30,000$ eV
 See page 211 for Explanation of Tables

$\mu_a(\text{barns/atom}) = \mu(\text{cm}^2/\text{gm}) \times 159.31$
 $E(\text{keV})\mu(\text{cm}^2/\text{gm}) = f_2 \times 438.59$

Molybdenum (Mo)
 $Z = 42$
 Atomic Weight = 95.940

Line	E(eV)	$\mu(\text{cm}^2/\text{gm})$	f_1	f_2	$\lambda(\text{\AA})$
H	10.2	9.03e + 4		2.10	1215
He I	21.2	1.50e + 5		7.27	584.3
Na L _{2,3}	30.5	5.08e + 4		3.53	407.2
Mg L _{2,3}	49.3	1.26e + 5		14.17	251.5
Al L _{2,3}	72.4	2.47e + 4	17.21	4.08	171.2
Si L _{2,3}	91.5	7.03e + 3	14.96	1.47	135.5
Be K	108.5	4.36e + 3	13.32	1.08	114.3
Y M ζ	114.0	4.37e + 3	12.88	1.14	108.8
Sr M ζ	132.8	4.94e + 3	11.87	1.50	93.4
Zr M ζ	151.1	5.57e + 3	11.12	1.92	82.1
B K α	183.3	5.71e + 3	9.94	2.39	67.6
Mo M ζ	192.6	5.60e + 3	9.45	2.46	64.4
Ar L l	220.1	5.70e + 3	6.86	2.86	56.3
C K α	277.0	2.14e + 4	4.54	13.50	44.8
Ag M ζ	311.7	2.37e + 4	7.56	16.85	39.8
N K α	392.4	2.45e + 4	14.36	21.89	31.6
Ti L α	452.2	2.19e + 4	20.06	22.61	27.4
V L α	511.3	1.91e + 4	24.12	22.32	24.2
O K α	524.9	1.85e + 4	25.11	22.13	23.6
Cr L α	572.8	1.59e + 4	28.23	20.70	21.6
Mn L α	637.4	1.26e + 4	30.36	18.34	19.5
F K α	676.8	1.13e + 4	31.17	17.41	18.3
Fe L α	705.0	1.05e + 4	31.74	16.83	17.6
Co L α	776.2	8.77e + 3	33.11	15.53	16.0
Ni L α	851.5	7.12e + 3	34.34	13.82	14.6
Cu L α	929.7	5.80e + 3	34.90	12.30	13.3
Zn L α	1011.7	4.84e + 3	35.19	11.17	12.3
Na K α	1041.0	4.54e + 3	35.34	10.78	11.9
Ge L α	1188.0	3.35e + 3	35.68	9.07	10.4
Mg K α	1253.6	2.96e + 3	35.73	8.46	9.9
Al K α	1486.7	1.98e + 3	35.61	6.71	8.3
Si K α	1740.0	1.35e + 3	35.07	5.36	7.1
Zr L α	2042.4	9.11e + 2	33.83	4.24	6.1
Mo L α	2293.2	6.84e + 2	31.73	3.57	5.4
Cl K α	2622.4	2.20e + 3	27.66	13.13	4.7
Ag L α	2984.3	2.02e + 3	35.52	13.78	4.2
Ca K α	3691.7	1.20e + 3	40.27	10.06	3.4
Ti K α	4510.8	7.12e + 2	41.71	7.32	2.7
V K α	4952.2	5.57e + 2	41.99	6.28	2.5
Cr K α	5414.7	4.39e + 2	42.14	5.42	2.3
Mn K α	5898.8	3.49e + 2	42.19	4.69	2.1
Co K α	6930.3	2.25e + 2	42.13	3.56	1.8
Ni K α	7478.2	1.83e + 2	42.07	3.12	1.7
Cu K α	8047.8	1.50e + 2	41.99	2.75	1.5
Ge K α	9886.4	8.50e + 1	41.72	1.92	1.3
Y K α	14988.0	2.67e + 1	40.91	0.91	0.8
Mo K α	17479.0	1.74e + 1	40.36	0.70	0.7
Pd K α	21177.0	6.97e + 1	39.98	3.37	0.6
Sn K α	25271.0	4.37e + 1	41.59	2.52	0.5
Xe K α	29779.0	2.80e + 1	42.02	1.90	0.4

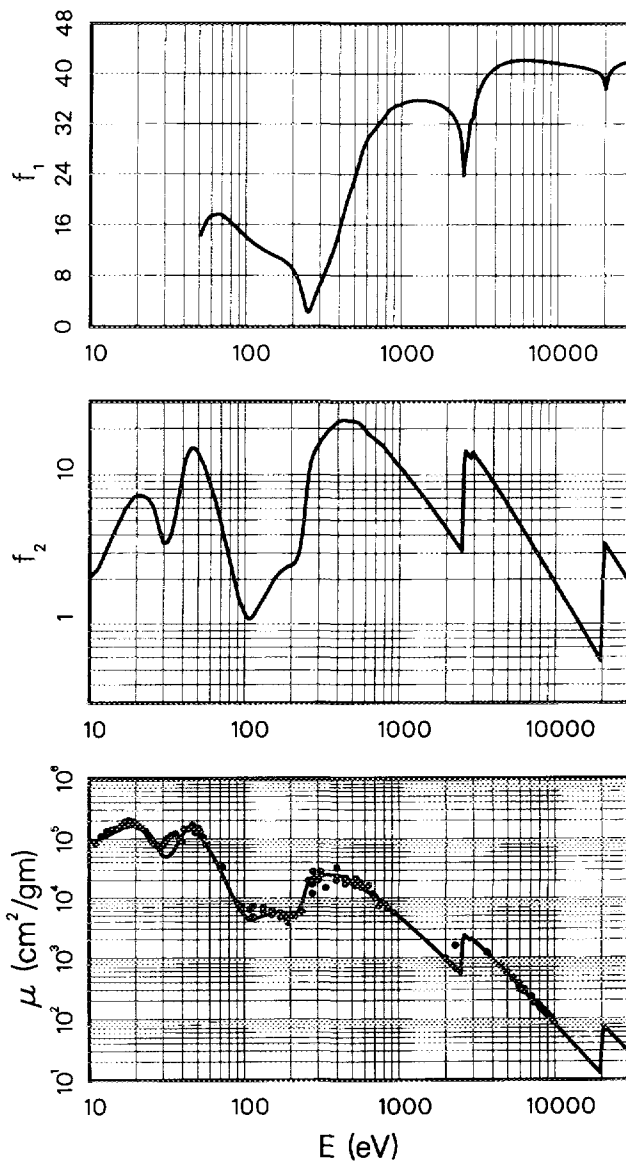

Edge Energies

K	19999.5 eV	L _I	2865.5 eV	M _I	506.3 eV ^b	N _I	63.2 eV ^b
		L _{II}	2625.1 eV	M _{II}	411.6 eV ^b	N _{II}	37.6 eV ^b
		L _{III}	2520.2 eV	M _{III}	394.0 eV ^b	N _{III}	35.5 eV ^b
				M _{IV}	231.1 eV ^b		
				M _V	227.9 eV ^b		

References: 33, 48, 52, 59, 76, 115, 123, 127, 131, 177, 200, 205, 223, 233.

TABLE I. Photoabsorption Cross Sections and Atomic Scattering Factors,
 $Z = 1-92$, $E = 50-30,000$ eV
 See page 211 for Explanation of Tables

$\mu_a(\text{barns/atom}) = \mu(\text{cm}^2/\text{gm}) \times 164.24$
 $E(\text{keV})\mu(\text{cm}^2/\text{gm}) = f_2 \times 425.44$

Technetium (Tc)
 $Z = 43$
 Atomic Weight = 98.906

Line	E(eV)	$\mu(\text{cm}^2/\text{gm})$	f_1	f_2	$\lambda(\text{\AA})$
H	10.2	5.12e+4		1.23	1215
He I	21.2	9.77e+4		4.87	584.3
Na L _{2,3}	30.5	6.60e+4		4.73	407.2
Mg L _{2,3}	49.3	1.22e+5		14.15	251.5
Al L _{2,3}	72.4	3.15e+4	18.22	5.36	171.2
Si L _{2,3}	91.5	9.79e+3	16.50	2.11	135.5
Be K	108.5	4.88e+3	14.69	1.24	114.3
Sr M ζ	114.0	4.68e+3	14.23	1.25	108.8
Y M ζ	132.8	5.08e+3	13.16	1.59	93.4
Zr M ζ	151.1	5.56e+3	12.54	1.97	82.1
B K α	183.3	5.56e+3	11.66	2.40	67.6
Mo M ζ	192.6	5.43e+3	11.31	2.46	64.4
Ar L ℓ	220.1	5.01e+3	9.84	2.59	56.3
C K α	277.0	1.21e+4	2.39	7.86	44.8
Ag M ζ	311.7	2.18e+4	4.49	15.97	39.8
N K α	392.4	2.39e+4	13.72	22.06	31.6
Ti L α	452.2	2.18e+4	19.35	23.15	27.4
V L α	511.3	1.86e+4	23.51	22.34	24.2
O K α	524.9	1.80e+4	24.17	22.27	23.6
Cr L α	572.8	1.63e+4	27.48	21.98	21.6
Mn L α	637.4	1.33e+4	30.45	19.90	19.5
F K α	676.8	1.18e+4	31.60	18.70	18.3
Fe L α	705.0	1.09e+4	32.30	18.04	17.6
Co L α	776.2	8.96e+3	33.78	16.35	16.0
Ni L α	851.5	7.38e+3	34.84	14.76	14.6
Cu L α	929.7	6.11e+3	35.63	13.35	13.3
Zn L α	1011.7	5.06e+3	36.20	12.04	12.3
Na K α	1041.0	4.75e+3	36.35	11.61	11.9
Ge L α	1188.0	3.50e+3	36.78	9.77	10.4
Mg K α	1253.6	3.09e+3	36.85	9.11	9.9
Al K α	1486.7	2.09e+3	36.86	7.29	8.3
Si K α	1740.0	1.44e+3	36.51	5.87	7.1
Zr L α	2042.4	9.74e+2	35.63	4.67	6.1
Mo L α	2293.2	7.32e+2	34.33	3.95	5.4
Cl K α	2622.4	5.24e+2	28.36	3.23	4.7
Ag L α	2984.3	1.88e+3	33.86	13.21	4.2
Ca K α	3691.7	1.24e+3	40.59	10.73	3.4
Ti K α	4510.8	7.39e+2	42.44	7.84	2.7
V K α	4952.2	5.78e+2	42.82	6.73	2.5
Cr K α	5414.7	4.57e+2	43.03	5.81	2.3
Mn K α	5898.8	3.63e+2	43.13	5.04	2.1
Co K α	6930.3	2.35e+2	43.13	3.83	1.8
Ni K α	7478.2	1.91e+2	43.08	3.36	1.7
Cu K α	8047.8	1.57e+2	43.01	2.96	1.5
Ge K α	9886.4	8.92e+1	42.75	2.07	1.3
Y K α	14988.0	2.83e+1	42.01	1.00	0.8
Mo K α	17479.0	1.84e+1	41.54	0.76	0.7
Pd K α	21177.0	6.55e+1	38.87	3.26	0.6
Sn K α	25271.0	4.55e+1	42.37	2.71	0.5
Xe K α	29779.0	2.94e+1	42.93	2.05	0.4

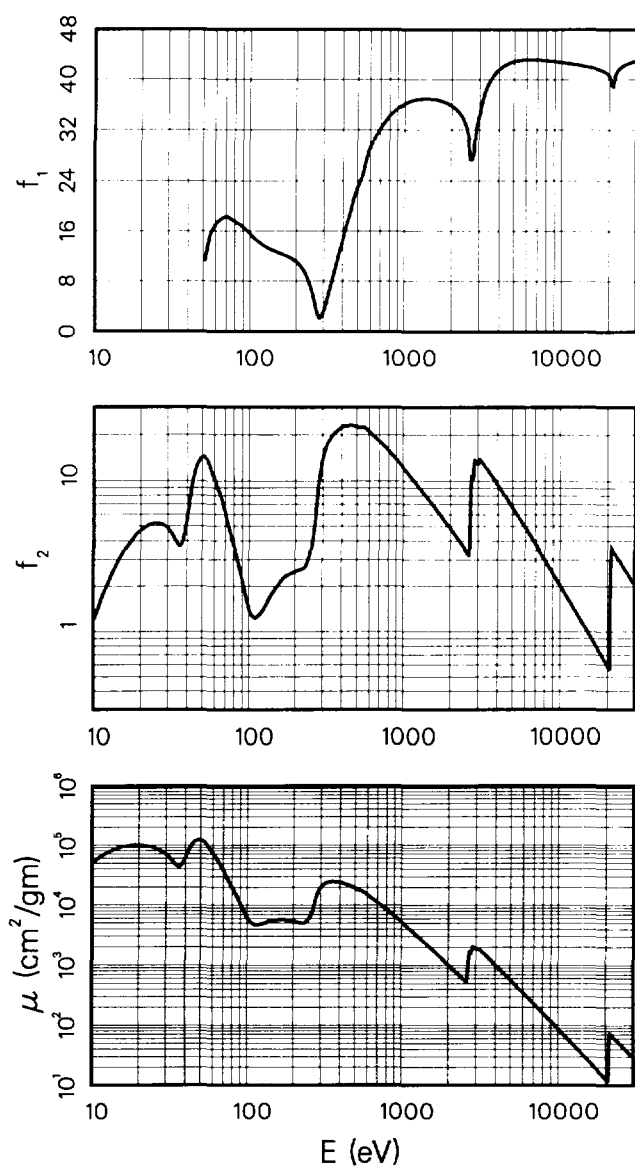

Edge Energies

K	21044.0 eV	L _I	3042.5 eV	M _I	544. eV ^a	N _I	68. eV ^a
		L _{II}	2793.2 eV	M _{II}	445. eV ^a	N _{II}	39. eV ^a
		L _{III}	2676.9 eV	M _{III}	425. eV ^a	N _{III}	39. eV ^a
				M _{IV}	257. eV ^a		
				M _V	253. eV ^a		

TABLE I. Photoabsorption Cross Sections and Atomic Scattering Factors,
 $Z = 1-92$, $E = 50-30,000$ eV
 See page 211 for Explanation of Tables

$\mu_a(\text{barns/atom}) = \mu(\text{cm}^2/\text{gm}) \times 167.83$
 $E(\text{keV})\mu(\text{cm}^2/\text{gm}) = f_2 \times 416.33$

Ruthenium (Ru)
 $Z = 44$
 Atomic Weight = 101.070

Line	E(eV)	$\mu(\text{cm}^2/\text{gm})$	f_1	f_2	$\lambda(\text{\AA})$
H	10.2	5.13e+4		1.26	1215
He I	21.2	1.40e+5		7.14	584.3
Na L _{2,3}	30.5	9.19e+4		6.72	407.2
Mg L _{2,3}	49.3	8.78e+4		10.40	251.5
Al L _{2,3}	72.4	5.30e+4	19.76	9.22	171.2
Si L _{2,3}	91.5	1.34e+4	18.64	2.95	135.5
Be K	108.5	5.94e+3	16.45	1.55	114.3
Sr M ζ	114.0	5.16e+3	15.87	1.41	108.8
Y M ζ	132.8	4.71e+3	14.34	1.50	93.4
Zr M ζ	151.1	5.63e+3	13.57	2.04	82.1
B K α	183.3	6.14e+3	12.81	2.70	67.6
Mo M ζ	192.6	6.14e+3	12.62	2.84	64.4
Ar L ℓ	220.1	5.77e+3	11.87	3.05	56.3
C K α	277.0	5.22e+3	7.38	3.47	44.8
Ag M ζ	311.7	1.31e+4	2.48	9.81	39.8
N K α	392.4	2.14e+4	11.11	20.22	31.6
Ti L α	452.2	2.07e+4	16.02	22.45	27.4
V L α	511.3	1.98e+4	20.47	24.33	24.2
O K α	524.9	1.95e+4	21.92	24.53	23.6
Cr L α	572.8	1.69e+4	25.64	23.28	21.6
Mn L α	637.4	1.46e+4	29.09	22.33	19.5
F K α	676.8	1.30e+4	30.94	21.09	18.3
Fe L α	705.0	1.20e+4	31.91	20.35	17.6
Co L α	776.2	9.89e+3	33.90	18.44	16.0
Ni L α	851.5	8.13e+3	35.27	16.62	14.6
Cu L α	929.7	6.74e+3	36.26	15.04	13.3
Zn L α	1011.7	5.60e+3	37.01	13.61	12.3
Na K α	1041.0	5.25e+3	37.23	13.13	11.9
Ge L α	1188.0	3.87e+3	37.86	11.05	10.4
Mg K α	1253.6	3.42e+3	38.01	10.30	9.9
Al K α	1486.7	2.31e+3	38.23	8.25	8.3
Si K α	1740.0	1.57e+3	38.03	6.54	7.1
Zr L α	2042.4	1.05e+3	37.32	5.15	6.1
Mo L α	2293.2	7.86e+2	36.34	4.33	5.4
Cl K α	2622.4	5.65e+2	33.80	3.56	4.7
Ag L α	2984.3	1.67e+3	31.04	11.97	4.2
Ca K α	3691.7	1.31e+3	40.53	11.60	3.4
Ti K α	4510.8	7.90e+2	43.03	8.55	2.7
V K α	4952.2	6.20e+2	43.56	7.37	2.5
Cr K α	5414.7	4.90e+2	43.87	6.38	2.3
Mn K α	5898.8	3.91e+2	44.03	5.54	2.1
Co K α	6930.3	2.53e+2	44.12	4.22	1.8
Ni K α	7478.2	2.06e+2	44.09	3.70	1.7
Cu K α	8047.8	1.69e+2	44.04	3.26	1.5
Ge K α	9886.4	9.62e+1	43.78	2.28	1.3
Y K α	14988.0	3.06e+1	43.10	1.10	0.8
Mo K α	17479.0	2.00e+1	42.72	0.84	0.7
Pd K α	21177.0	1.17e+1	41.30	0.60	0.6
Sn K α	25271.0	4.85e+1	43.02	2.94	0.5
Xe K α	29779.0	3.14e+1	43.80	2.25	0.4

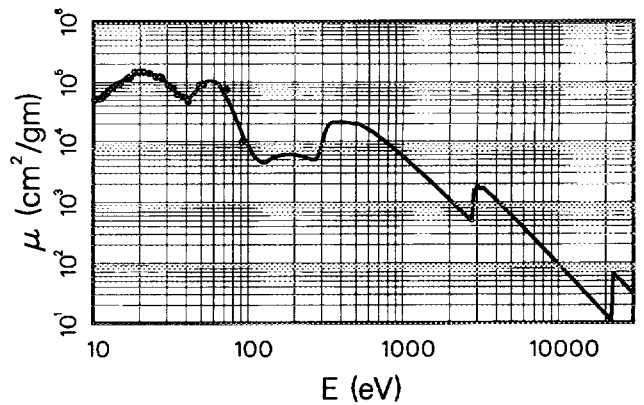
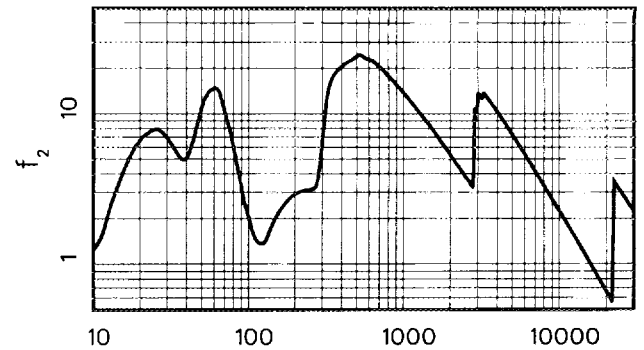
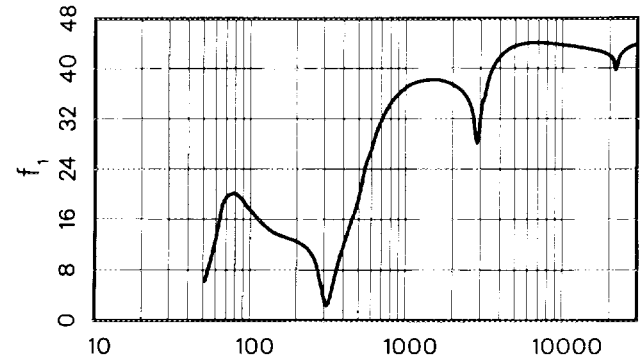

Edge Energies

K	22117.2 eV	L _I	3224.0 eV	M _I	586.2 eV ^b	N _I	75.0 eV ^b
		L _{II}	2966.9 eV	M _{II}	483.5 eV ^b	N _{II}	46.5 eV ^b
		L _{III}	2837.9 eV	M _{III}	461.4 eV ^b	N _{III}	43.2 eV ^b
				M _{IV}	284.2 eV ^b		
				M _V	280.0 eV ^b		

References: 232.

TABLE I. Photoabsorption Cross Sections and Atomic Scattering Factors.
 $Z = 1-92, E = 50-30,000 \text{ eV}$
 See page 211 for Explanation of Tables

$\mu_a(\text{barns/atom}) = \mu(\text{cm}^2/\text{gm}) \times 170.88$
 $E(\text{keV})\mu(\text{cm}^2/\text{gm}) = f_2 \times 408.90$

Rhodium (Rh)
 $Z = 45$
 Atomic Weight = 102.906

Line	E(eV)	$\mu(\text{cm}^2/\text{gm})$	f_1	f_2	$\lambda(\text{\AA})$
H	10.2	5.03e+4		1.26	1215
He I	21.2	1.45e+5		7.53	584.3
Na L _{2,3}	30.5	1.25e+5		9.28	407.2
Mg L _{2,3}	49.3	1.02e+5		12.31	251.5
Al L _{2,3}	72.4	8.53e+4	18.89	15.10	171.2
Si L _{2,3}	91.5	2.39e+4	21.14	5.35	135.5
Be K	108.5	8.59e+3	18.59	2.28	114.3
Sr M ζ	114.0	6.27e+3	17.77	1.75	108.8
Y M ζ	132.8	4.41e+3	15.46	1.43	93.4
Zr M ζ	151.1	5.00e+3	14.17	1.85	82.1
B K α	183.3	6.33e+3	13.10	2.84	67.6
Mo M ζ	192.6	6.42e+3	12.90	3.03	64.4
Ar L l	220.1	6.55e+3	12.30	3.53	56.3
C K α	277.0	5.68e+3	10.18	3.85	44.8
Ag M ζ	311.7	5.80e+3	6.04	4.42	39.8
N K α	392.4	2.11e+4	7.67	20.27	31.6
Ti L α	452.2	2.14e+4	14.07	23.64	27.4
V L α	511.3	2.01e+4	19.31	25.18	24.2
O K α	524.9	1.96e+4	20.60	25.17	23.6
Cr L α	572.8	1.76e+4	23.98	24.69	21.6
Mn L α	637.4	1.56e+4	28.14	24.34	19.5
F K α	676.8	1.39e+4	30.43	23.06	18.3
Fe L α	705.0	1.29e+4	31.61	22.27	17.6
Co L α	776.2	1.07e+4	33.95	20.22	16.0
Ni L α	851.5	8.77e+3	35.60	18.27	14.6
Cu L α	929.7	7.27e+3	36.79	16.53	13.3
Zn L α	1011.7	6.04e+3	37.68	14.94	12.3
Na K α	1041.0	5.66e+3	37.93	14.41	11.9
Ge L α	1188.0	4.18e+3	38.69	12.15	10.4
Mg K α	1253.6	3.70e+3	38.88	11.33	9.9
Al K α	1486.7	2.50e+3	39.19	9.09	8.3
Si K α	1740.0	1.72e+3	39.11	7.32	7.1
Zr L α	2042.4	1.16e+3	38.61	5.81	6.1
Mo L α	2293.2	8.71e+2	37.90	4.88	5.4
Cl K α	2622.4	6.17e+2	36.23	3.96	4.7
Ag L α	2984.3	8.48e+2	29.75	6.19	4.2
Ca K α	3691.7	1.44e+3	40.16	12.96	3.4
Ti K α	4510.8	8.64e+2	43.69	9.53	2.7
V K α	4952.2	6.78e+2	44.40	8.21	2.5
Cr K α	5414.7	5.36e+2	44.82	7.10	2.3
Mn K α	5898.8	4.27e+2	45.04	6.16	2.1
Co K α	6930.3	2.77e+2	45.20	4.70	1.8
Ni K α	7478.2	2.26e+2	45.20	4.13	1.7
Cu K α	8047.8	1.85e+2	45.16	3.64	1.5
Ge K α	9886.4	1.05e+2	44.97	2.54	1.3
Y K α	14988.0	3.31e+1	44.26	1.21	0.8
Mo K α	17479.0	2.16e+1	43.93	0.92	0.7
Pd K α	21177.0	1.27e+1	43.13	0.66	0.6
Sn K α	25271.0	5.12e+1	43.39	3.17	0.5
Xe K α	29779.0	3.33e+1	44.60	2.42	0.4

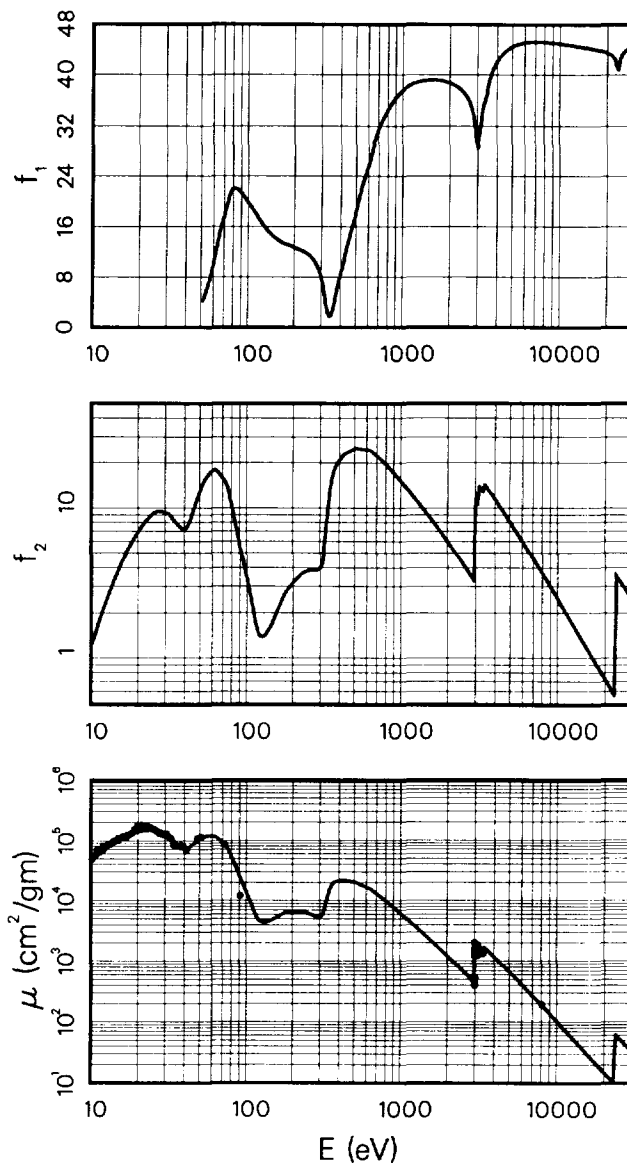

Edge Energies

K	23219.9 eV	L _I	3411.9 eV	M _I	628.1 eV ^b	N _I	81.4 eV ^b
		L _{II}	3146.1 eV	M _{II}	521.3 eV ^b	N _{II}	50.5 eV ^b
		L _{III}	3003.8 eV	M _{III}	496.5 eV ^b	N _{III}	47.3 eV ^b
				M _{IV}	311.9 eV ^b		
				M _V	307.2 eV ^b		

References: 76, 119, 223, 232.

TABLE I. Photoabsorption Cross Sections and Atomic Scattering Factors,
 $Z = 1-92$, $E = 50-30,000$ eV

See page 211 for Explanation of Tables

$\mu_a(\text{barns/atom}) = \mu(\text{cm}^2/\text{gm}) \times 176.72$
 $E(\text{keV})\mu(\text{cm}^2/\text{gm}) = f_2 \times 395.40$

Palladium (Pd)
 $Z = 46$
 Atomic Weight = 106.420

Line	E(eV)	$\mu(\text{cm}^2/\text{gm})$	f_1	f_2	$\lambda(\text{\AA})$
H	10.2	4.74e+4		1.22	1215
He I	21.2	1.23e+5		6.60	584.3
Na L _{2,3}	30.5	1.24e+5		9.55	407.2
Mg L _{2,3}	49.3	1.10e+5		13.78	251.5
Al L _{2,3}	72.4	8.89e+4	16.34	16.27	171.2
Si L _{2,3}	91.5	3.66e+4	22.32	8.47	135.5
Be K	108.5	1.35e+4	20.76	3.71	114.3
Sr M ζ	114.0	9.34e+3	19.95	2.69	108.8
Y M ζ	132.8	4.27e+3	17.06	1.43	93.4
Zr M ζ	151.1	4.93e+3	15.27	1.89	82.1
B K α	183.3	6.32e+3	14.11	2.93	67.6
Mo M ζ	192.6	6.49e+3	13.90	3.16	64.4
Ar L ℓ	220.1	6.77e+3	13.45	3.77	56.3
C K α	277.0	6.02e+3	12.39	4.22	44.8
Ag M ζ	311.7	5.34e+3	10.40	4.21	39.8
N K α	392.4	1.64e+4	3.36	16.26	31.6
Ti L α	452.2	1.96e+4	10.77	22.42	27.4
V L α	511.3	1.93e+4	16.14	24.97	24.2
O K α	524.9	1.91e+4	17.30	25.41	23.6
Cr L α	572.8	1.81e+4	21.65	26.17	21.6
Mn L α	637.4	1.58e+4	26.33	25.43	19.5
F K α	676.8	1.46e+4	28.64	25.03	18.3
Fe L α	705.0	1.37e+4	30.29	24.46	17.6
Co L α	776.2	1.14e+4	33.48	22.36	16.0
Ni L α	851.5	9.39e+3	35.60	20.23	14.6
Cu L α	929.7	7.80e+3	37.09	18.35	13.3
Zn L α	1011.7	6.51e+3	38.24	16.65	12.3
Na K α	1041.0	6.10e+3	38.58	16.06	11.9
Ge L α	1188.0	4.50e+3	39.61	13.51	10.4
Mg K α	1253.6	3.97e+3	39.87	12.59	9.9
Al K α	1486.7	2.68e+3	40.30	10.07	8.3
Si K α	1740.0	1.86e+3	40.35	8.18	7.1
Zr L α	2042.4	1.27e+3	40.04	6.54	6.1
Mo L α	2293.2	9.50e+2	39.54	5.51	5.4
Cl K α	2622.4	6.73e+2	38.38	4.46	4.7
Ag L α	2984.3	4.75e+2	35.40	3.59	4.2
Ca K α	3691.7	1.46e+3	38.85	13.64	3.4
Ti K α	4510.8	9.00e+2	44.02	10.27	2.7
V K α	4952.2	7.11e+2	44.97	8.90	2.5
Cr K α	5414.7	5.65e+2	45.54	7.73	2.3
Mn K α	5898.8	4.51e+2	45.89	6.73	2.1
Co K α	6930.3	2.94e+2	46.18	5.15	1.8
Ni K α	7478.2	2.39e+2	46.21	4.52	1.7
Cu K α	8047.8	1.96e+2	46.19	3.98	1.5
Ge K α	9886.4	1.11e+2	46.03	2.78	1.3
Y K α	14988.0	3.48e+1	45.35	1.32	0.8
Mo K α	17479.0	2.27e+1	45.02	1.00	0.7
Pd K α	21177.0	1.34e+1	44.39	0.72	0.6
Sn K α	25271.0	5.30e+1	43.18	3.38	0.5
Xe K α	29779.0	3.46e+1	45.39	2.61	0.4

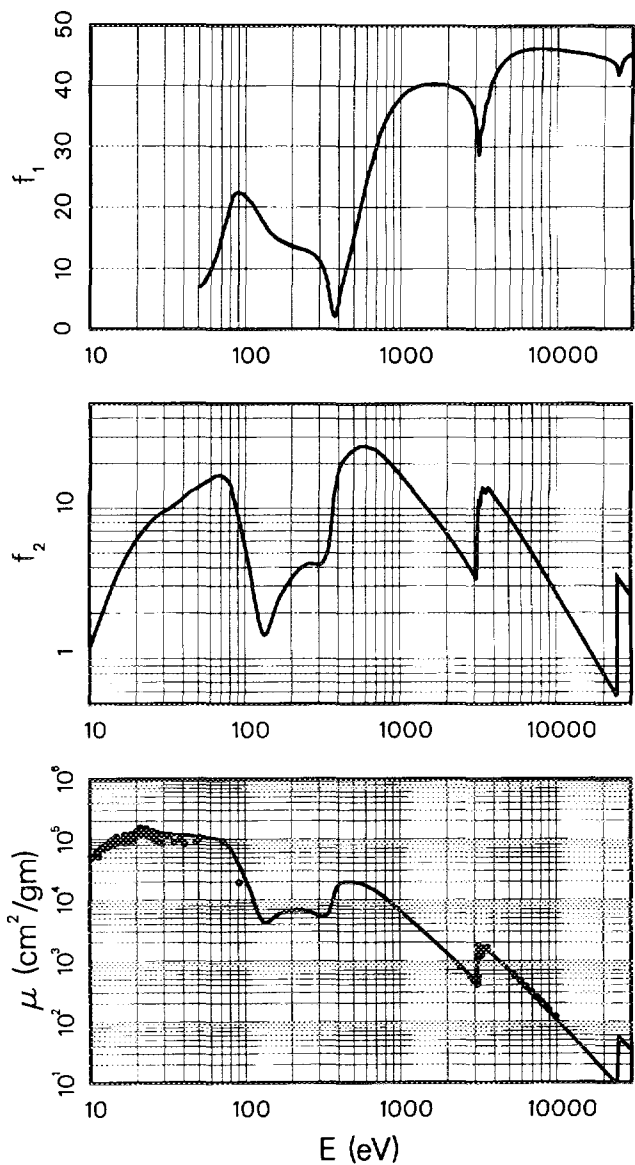

Edge Energies

K	24350.3 eV	L _I	3604.3 eV	M _I	671.6 eV ^b	N _I	87.6 eV ^b
		L _{II}	3330.3 eV	M _{II}	559.9 eV ^b	N _{II}	55.7 eV ^b
		L _{III}	3173.3 eV	M _{III}	532.3 eV ^b	N _{III}	50.9 eV ^b
				M _{IV}	340.5 eV ^b		
				M _V	335.2 eV ^b		

References: 48, 64, 76, 99, 223, 232.

TABLE I. Photoabsorption Cross Sections and Atomic Scattering Factors,
 $Z = 1-92$, $E = 50-30,000$ eV
 See page 211 for Explanation of Tables

$\mu_a(\text{barns/atom}) = \mu(\text{cm}^2/\text{gm}) \times 179.12$
 $E(\text{keV})\mu(\text{cm}^2/\text{gm}) = f_2 \times 390.09$

Silver (Ag)
 $Z = 47$
 Atomic Weight = 107.868

Line	E(eV)	$\mu(\text{cm}^2/\text{gm})$	f_1	f_2	$\lambda(\text{\AA})$
H	10.2	4.74e+4		1.24	1215
He I	21.2	1.32e+5		7.16	584.3
Na L _{2,3}	30.5	1.37e+5		10.69	407.2
Mg L _{2,3}	49.3	1.25e+5		15.78	251.5
Al L _{2,3}	72.4	1.05e+5	13.00	19.40	171.2
Si L _{2,3}	91.5	7.11e+4	22.71	16.67	135.5
Be K	108.5	2.10e+4	25.23	5.85	114.3
Sr M ζ	114.0	1.32e+4	23.69	3.85	108.8
Y M ζ	132.8	5.09e+3	19.24	1.73	93.4
Zr M ζ	151.1	4.62e+3	16.67	1.79	82.1
B K α	183.3	7.28e+3	14.83	3.42	67.6
Mo M ζ	192.6	7.51e+3	14.72	3.71	64.4
Ar L ℓ	220.1	7.55e+3	14.37	4.26	56.3
C K α	277.0	6.87e+3	13.72	4.88	44.8
Ag M ζ	311.7	5.92e+3	12.74	4.73	39.8
N K α	392.4	8.61e+3	2.70	8.66	31.6
Ti L α	452.2	1.92e+4	7.41	22.21	27.4
V L α	511.3	1.97e+4	14.54	25.79	24.2
O K α	524.9	1.95e+4	15.87	26.18	23.6
Cr L α	572.8	1.85e+4	20.39	27.18	21.6
Mn L α	637.4	1.63e+4	25.37	26.59	19.5
F K α	676.8	1.51e+4	27.71	26.17	18.3
Fe L α	705.0	1.43e+4	29.33	25.90	17.6
Co L α	776.2	1.22e+4	33.07	24.29	16.0
Ni L α	851.5	1.02e+4	35.85	22.24	14.6
Cu L α	929.7	8.32e+3	37.82	19.83	13.3
Zn L α	1011.7	6.92e+3	39.04	17.96	12.3
Na K α	1041.0	6.50e+3	39.41	17.33	11.9
Ge L α	1188.0	4.81e+3	40.59	14.64	10.4
Mg K α	1253.6	4.25e+3	40.91	13.67	9.9
Al K α	1486.7	2.88e+3	41.59	10.99	8.3
Si K α	1740.0	1.97e+3	41.77	8.78	7.1
Zr L α	2042.4	1.32e+3	41.48	6.93	6.1
Mo L α	2293.2	9.91e+2	41.01	5.83	5.4
Cl K α	2622.4	7.09e+2	40.06	4.76	4.7
Ag L α	2984.3	5.14e+2	38.24	3.93	4.2
Ca K α	3691.7	1.35e+3	37.73	12.82	3.4
Ti K α	4510.8	9.49e+2	44.35	10.97	2.7
V K α	4952.2	7.49e+2	45.55	9.50	2.5
Cr K α	5414.7	5.95e+2	46.28	8.25	2.3
Mn K α	5898.8	4.75e+2	46.71	7.19	2.1
Co K α	6930.3	3.10e+2	47.10	5.50	1.8
Ni K α	7478.2	2.52e+2	47.16	4.84	1.7
Cu K α	8047.8	2.07e+2	47.16	4.27	1.5
Ge K α	9886.4	1.18e+2	47.01	2.99	1.3
Y K α	14988.0	3.76e+1	46.41	1.44	0.8
Mo K α	17479.0	2.46e+1	46.13	1.10	0.7
Pd K α	21177.0	1.44e+1	45.61	0.78	0.6
Sn K α	25271.0	1.20e+1	43.27	0.78	0.5
Xe K α	29779.0	3.67e+1	46.14	2.80	0.4

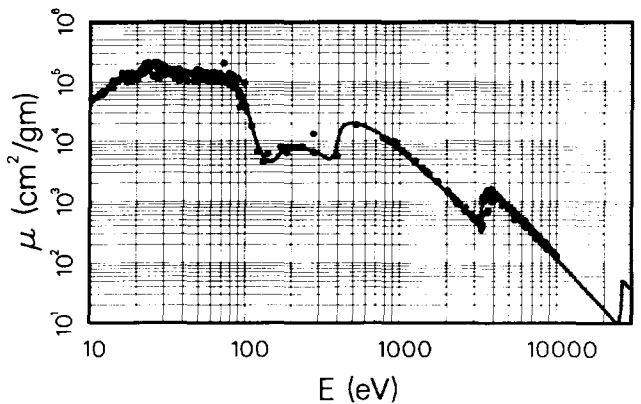
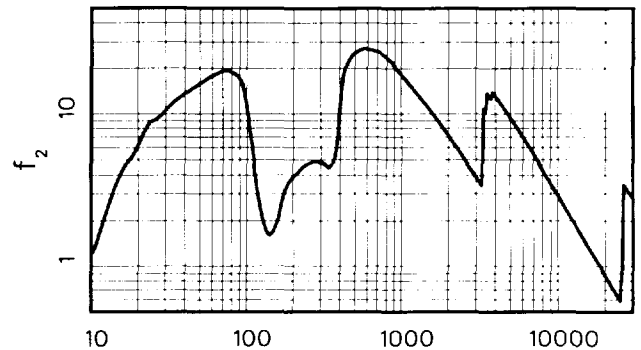
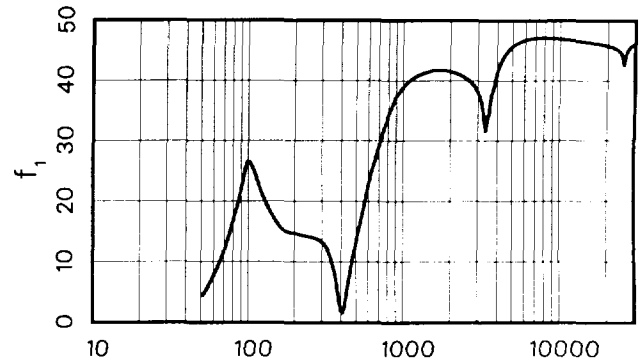

Edge Energies

K	25514.0 eV	L _I	3805.8 eV	M _I	719.0 eV ^b	N _I	97.0 eV ^b
		L _{II}	3523.7 eV	M _{II}	603.8 eV ^b	N _{II}	63.7 eV ^b
		L _{III}	3351.1 eV	M _{III}	573.0 eV ^b	N _{III}	58.3 eV ^b
				M _{IV}	374.0 eV ^b		
				M _V	368.0 eV ^b		

References: 2, 4, 7, 17, 24, 25, 27, 28, 48, 52, 58, 65, 73, 79, 99, 122, 123, 127, 131, 175, 185, 188, 200, 201, 202, 222, 223, 232.

TABLE I. Photoabsorption Cross Sections and Atomic Scattering Factors.
 $Z = 1-92$, $E = 50-30,000$ eV
 See page 211 for Explanation of Tables

Cadmium (Cd)
 $Z = 48$

Atomic Weight = 112.411

μ_a (barns/atom) = μ (cm²/gm) \times 186.67
 E (keV) μ (cm²/gm) = $f_2 \times 374.32$

Line	E(eV)	μ (cm ² /gm)	f_1	f_2	λ (Å)
H	10.2	1.55e+4		0.42	1215
He I	21.2	5.16e+4		2.93	584.3
Na L _{2,3}	30.5	7.98e+4		6.49	407.2
Mg L _{2,3}	49.3	9.00e+4		11.86	251.5
Al L _{2,3}	72.4	7.74e+4	12.58	14.97	171.2
Si L _{2,3}	91.5	5.95e+4	18.87	14.55	135.5
Be K	108.5	3.24e+4	23.53	9.38	114.3
Sr M ζ	114.0	2.48e+4	23.76	7.57	108.8
Y M ζ	132.8	9.53e+3	21.40	3.38	93.4
Zr M ζ	151.1	4.76e+3	19.17	1.92	82.1
B K α	183.3	5.40e+3	16.58	2.64	67.6
Mo M ζ	192.6	5.68e+3	16.26	2.92	64.4
Ar L l	220.1	6.28e+3	15.73	3.69	56.3
C K α	277.0	6.03e+3	15.35	4.46	44.8
Ag M ζ	311.7	5.36e+3	14.68	4.47	39.8
N K α	392.4	4.40e+3	9.92	4.61	31.6
Ti L α	452.2	1.12e+4	0.99	13.53	27.4
V L α	511.3	1.98e+4	12.22	27.07	24.2
O K α	524.9	1.92e+4	14.66	26.87	23.6
Cr L α	572.8	1.68e+4	18.86	25.66	21.6
Mn L α	637.4	1.53e+4	23.07	26.11	19.5
F K α	676.8	1.45e+4	25.46	26.21	18.3
Fe L α	705.0	1.39e+4	27.16	26.12	17.6
Co L α	776.2	1.23e+4	31.14	25.47	16.0
Ni L α	851.5	1.04e+4	34.83	23.75	14.6
Cu L α	929.7	8.71e+3	37.20	21.64	13.3
Zn L α	1011.7	7.27e+3	38.99	19.66	12.3
Na K α	1041.0	6.82e+3	39.51	18.96	11.9
Ge L α	1188.0	5.01e+3	41.08	15.90	10.4
Mg K α	1253.6	4.42e+3	41.48	14.80	9.9
Al K α	1486.7	2.98e+3	42.19	11.82	8.3
Si K α	1740.0	2.10e+3	42.49	9.75	7.1
Zr L α	2042.4	1.44e+3	42.54	7.86	6.1
Mo L α	2293.2	1.08e+3	42.34	6.61	5.4
Cl K α	2622.4	7.54e+2	41.70	5.28	4.7
Ag L α	2984.3	5.18e+2	40.36	4.13	4.2
Ca K α	3691.7	1.23e+3	34.93	12.12	3.4
Ti K α	4510.8	1.01e+3	44.30	12.16	2.7
V K α	4952.2	7.95e+2	45.97	10.52	2.5
Cr K α	5414.7	6.31e+2	46.93	9.13	2.3
Mn K α	5898.8	5.04e+2	47.52	7.95	2.1
Co K α	6930.3	3.29e+2	48.07	6.09	1.8
Ni K α	7478.2	2.68e+2	48.17	5.36	1.7
Cu K α	8047.8	2.20e+2	48.21	4.73	1.5
Ge K α	9886.4	1.25e+2	48.15	3.31	1.3
Y K α	14988.0	3.94e+1	47.50	1.58	0.8
Mo K α	17479.0	2.57e+1	47.21	1.20	0.7
Pd K α	21177.0	1.51e+1	46.75	0.85	0.6
Sn K α	25271.0	9.23e+0	45.70	0.62	0.5
Xe K α	29779.0	3.79e+1	46.75	3.02	0.4

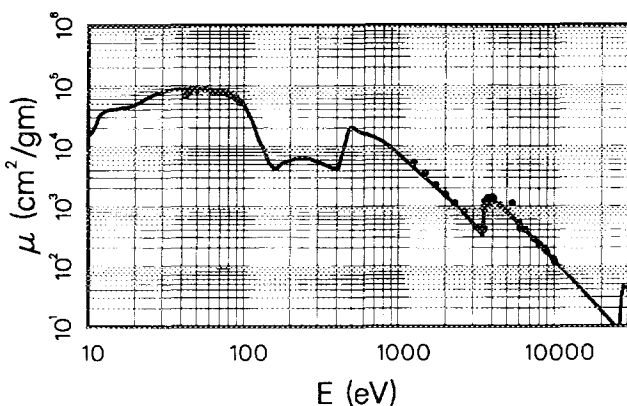
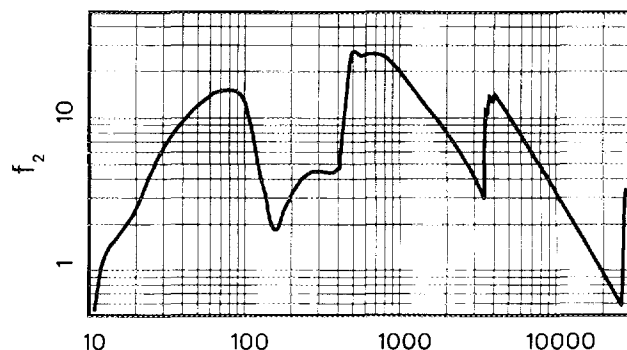
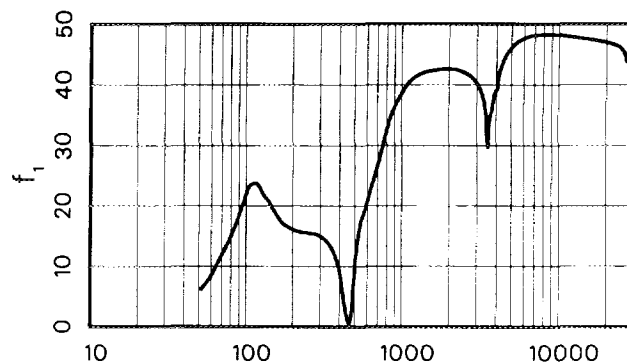

Edge Energies

K	26711.2 eV	L _I	4018.0 eV	M _I	772.0 eV ^b	N _I	109.8 eV ^b
		L _{II}	3727.0 eV	M _{II}	652.6 eV ^b	N _{II}	63.9 eV ^b
		L _{III}	3537.5 eV	M _{III}	618.4 eV ^b	N _{III}	63.9 eV ^b
				M _{IV}	411.9 eV ^b	N _{IV}	11.7 eV ^b
				M _V	405.2 eV ^b	N _V	10.7 eV ^b

References: 24, 25, 48, 54, 178, 207.

TABLE I. Photoabsorption Cross Sections and Atomic Scattering Factors,
 $Z = 1-92, E = 50-30,000 \text{ eV}$
 See page 211 for Explanation of Tables

$\mu_a(\text{barns/atom}) = \mu(\text{cm}^2/\text{gm}) \times 190.67$
 $E(\text{keV})\mu(\text{cm}^2/\text{gm}) = f_2 \times 366.47$

Indium (In)
 $Z = 49$
 Atomic Weight = 114.820

Line	E(eV)	$\mu(\text{cm}^2/\text{gm})$	f_1	f_2	$\lambda (\text{\AA})$
H	10.2	7.36e + 4		2.05	1215
He I	21.2	3.00e + 4		1.74	584.3
Na L _{2,3}	30.5	5.81e + 4		4.83	407.2
Mg L _{2,3}	49.3	1.04e + 5		14.02	251.5
Al L _{2,3}	72.4	1.01e + 5	8.32	19.90	171.2
Si L _{2,3}	91.5	9.00e + 4	21.96	22.47	135.5
Be K	108.5	4.08e + 4	27.30	12.07	114.3
Sr M ζ	114.0	3.12e + 4	27.02	9.71	108.8
Y M ζ	132.8	1.28e + 4	25.21	4.62	93.4
Zr M ζ	151.1	4.53e + 3	21.46	1.87	82.1
B K α	183.3	5.06e + 3	17.91	2.53	67.6
Mo M ζ	192.6	5.45e + 3	17.39	2.87	64.4
Ar L ℓ	220.1	6.56e + 3	16.48	3.94	56.3
C K α	277.0	7.40e + 3	16.23	5.59	44.8
Ag M ζ	311.7	6.89e + 3	16.33	5.86	39.8
N K α	392.4	4.98e + 3	14.07	5.33	31.6
Ti L α	452.2	4.96e + 3	5.34	6.12	27.4
V L α	511.3	1.68e + 4	8.61	23.40	24.2
O K α	524.9	1.71e + 4	11.17	24.55	23.6
Cr L α	572.8	1.58e + 4	17.58	24.65	21.6
Mn L α	637.4	1.37e + 4	20.43	23.81	19.5
F K α	676.8	1.48e + 4	21.06	27.38	18.3
Fe L α	705.0	1.48e + 4	25.14	28.53	17.6
Co L α	776.2	1.24e + 4	30.26	26.22	16.0
Ni L α	851.5	1.09e + 4	33.90	25.39	14.6
Cu L α	929.7	9.20e + 3	37.09	23.35	13.3
Zn L α	1011.7	7.70e + 3	39.25	21.25	12.3
Na K α	1041.0	7.22e + 3	39.87	20.50	11.9
Ge L α	1188.0	5.32e + 3	41.79	17.24	10.4
Mg K α	1253.6	4.70e + 3	42.31	16.07	9.9
Al K α	1486.7	3.17e + 3	43.34	12.86	8.3
Si K α	1740.0	2.20e + 3	43.77	10.46	7.1
Zr L α	2042.4	1.51e + 3	43.81	8.41	6.1
Mo L α	2293.2	1.14e + 3	43.62	7.14	5.4
Cl K α	2622.4	8.21e + 2	43.13	5.87	4.7
Ag L α	2984.3	5.93e + 2	42.21	4.83	4.2
Ca K α	3691.7	6.04e + 2	35.05	6.08	3.4
Ti K α	4510.8	1.03e + 3	44.08	12.62	2.7
V K α	4952.2	8.10e + 2	46.28	10.95	2.5
Cr K α	5414.7	6.44e + 2	47.49	9.52	2.3
Mn K α	5898.8	5.16e + 2	48.20	8.30	2.1
Co K α	6930.3	3.37e + 2	48.89	6.37	1.8
Ni K α	7478.2	2.75e + 2	49.03	5.61	1.7
Cu K α	8047.8	2.26e + 2	49.10	4.96	1.5
Ge K α	9886.4	1.30e + 2	49.02	3.50	1.3
Y K α	14988.0	4.19e + 1	48.54	1.71	0.8
Mo K α	17479.0	2.74e + 1	48.29	1.31	0.7
Pd K α	21177.0	1.61e + 1	47.88	0.93	0.6
Sn K α	25271.0	9.85e + 0	47.16	0.68	0.5
Xe K α	29779.0	3.97e + 1	47.02	3.23	0.4

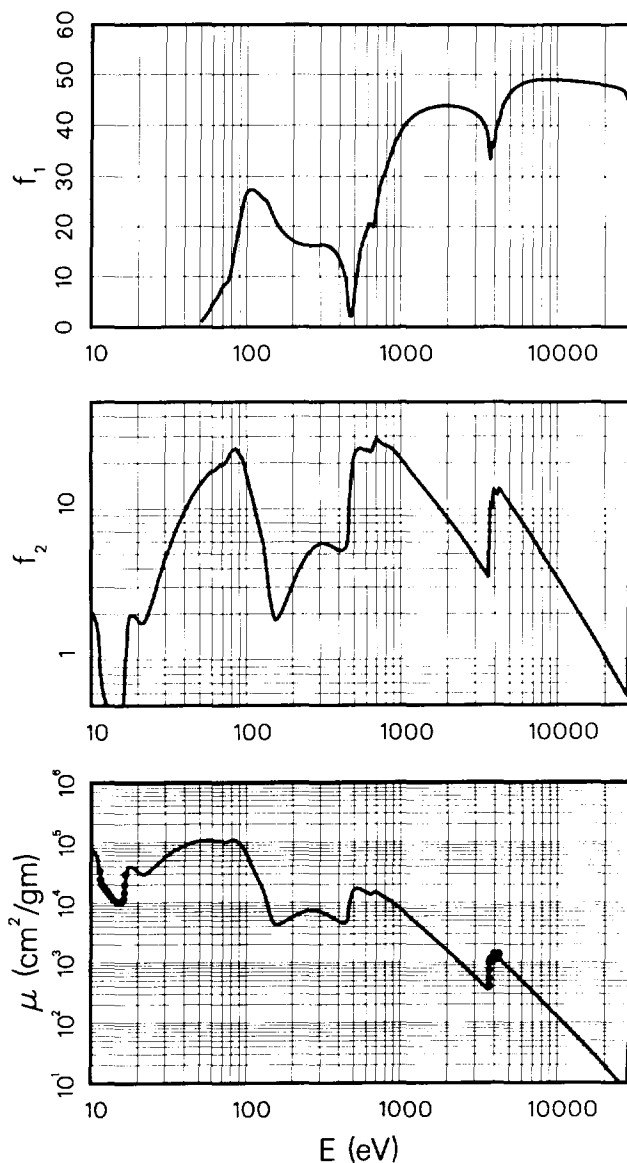

Edge Energies

K	27939.9 eV	L _I	4237.5 eV	M _I	827.2 eV ^b	N _I	122.9 eV ^b
		L _{II}	3938.0 eV	M _{II}	703.2 eV ^b	N _{II}	73.5 eV ^b
		L _{III}	3730.1 eV	M _{III}	665.3 eV ^b	N _{III}	73.5 eV ^b
				M _{IV}	451.4 eV ^b	N _{IV}	17.7 eV ^b
				M _V	443.9 eV ^b	N _V	16.9 eV ^b

References: 58, 99.

TABLE I. Photoabsorption Cross Sections and Atomic Scattering Factors,
 $Z = 1-92$, $E = 50-30,000$ eV
 See page 211 for Explanation of Tables

$\mu_a(\text{barns/atom}) = \mu(\text{cm}^2/\text{gm}) \times 197.13$
 $E(\text{keV})\mu(\text{cm}^2/\text{gm}) = f_2 \times 354.46$

Tin (Sn)
 $Z = 50$
 Atomic Weight = 118.710

Line	E(eV)	$\mu(\text{cm}^2/\text{gm})$	f_1	f_2	$\lambda(\text{\AA})$
H	10.2	1.37e+5		3.93	1215
He I	21.2	1.02e+4		0.61	584.3
Na L _{2,3}	30.5	5.36e+4		4.60	407.2
Mg L _{2,3}	49.3	9.29e+4		12.92	251.5
Al L _{2,3}	72.4	1.19e+5	6.91	24.24	171.2
Si L _{2,3}	91.5	9.32e+4	19.10	24.05	135.5
Be K	108.5	5.71e+4	27.71	17.47	114.3
Sr M ζ	114.0	4.49e+4	28.34	14.45	108.8
Y M ζ	132.8	1.86e+4	27.28	6.98	93.4
Zr M ζ	151.1	6.99e+3	24.48	2.98	82.1
B K α	183.3	5.18e+3	19.15	2.68	67.6
Mo M ζ	192.6	5.76e+3	18.56	3.13	64.4
Ar L ℓ	220.1	6.88e+3	17.59	4.27	56.3
C K α	277.0	7.36e+3	17.40	5.75	44.8
Ag M ζ	311.7	6.86e+3	17.54	6.03	39.8
N K α	392.4	5.02e+3	16.27	5.55	31.6
Ti L α	452.2	4.19e+3	12.45	5.35	27.4
V L α	511.3	9.12e+3	2.15	13.16	24.2
O K α	524.9	1.27e+4	2.87	18.77	23.6
Cr L α	572.8	1.60e+4	12.79	25.90	21.6
Mn L α	637.4	1.43e+4	20.14	25.71	19.5
F K α	676.8	1.32e+4	22.17	25.17	18.3
Fe L α	705.0	1.26e+4	22.29	24.97	17.6
Co L α	776.2	1.32e+4	27.40	28.80	16.0
Ni L α	851.5	1.13e+4	32.60	27.24	14.6
Cu L α	929.7	9.79e+3	36.01	25.68	13.3
Zn L α	1011.7	8.05e+3	39.47	22.97	12.3
Na K α	1041.0	7.55e+3	40.03	22.17	11.9
Ge L α	1188.0	5.57e+3	42.19	18.67	10.4
Mg K α	1253.6	4.92e+3	42.80	17.41	9.9
Al K α	1486.7	3.33e+3	44.05	13.97	8.3
Si K α	1740.0	2.33e+3	44.63	11.42	7.1
Zr L α	2042.4	1.60e+3	44.82	9.22	6.1
Mo L α	2293.2	1.21e+3	44.75	7.85	5.4
Cl K α	2622.4	8.73e+2	44.39	6.46	4.7
Ag L α	2984.3	6.29e+2	43.68	5.30	4.2
Ca K α	3691.7	3.57e+2	40.08	3.72	3.4
Ti K α	4510.8	1.06e+3	42.35	13.52	2.7
V K α	4952.2	8.50e+2	46.09	11.87	2.5
Cr K α	5414.7	6.82e+2	47.73	10.42	2.3
Mn K α	5898.8	5.49e+2	48.71	9.14	2.1
Co K α	6930.3	3.62e+2	49.70	7.07	1.8
Ni K α	7478.2	2.96e+2	49.93	6.24	1.7
Cu K α	8047.8	2.43e+2	50.07	5.52	1.5
Ge K α	9886.4	1.39e+2	50.12	3.88	1.3
Y K α	14988.0	4.40e+1	49.61	1.86	0.8
Mo K α	17479.0	2.87e+1	49.35	1.41	0.7
Pd K α	21177.0	1.68e+1	48.95	1.01	0.6
Sn K α	25271.0	1.03e+1	48.32	0.74	0.5
Xe K α	29779.0	4.01e+1	47.03	3.37	0.4

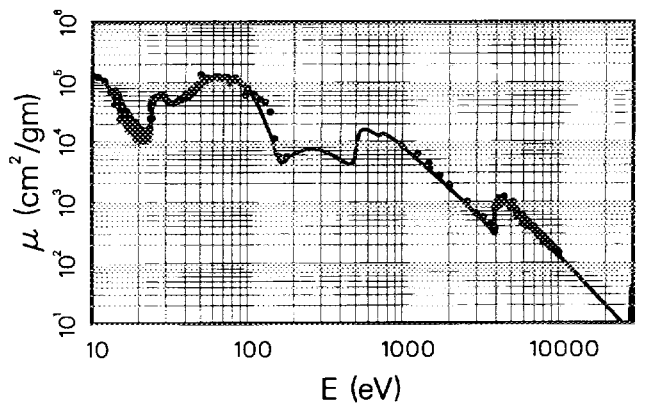
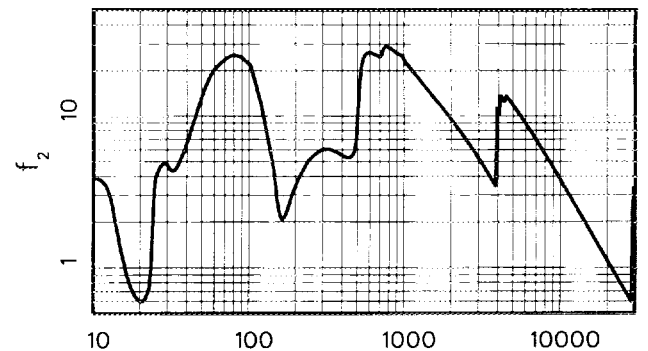
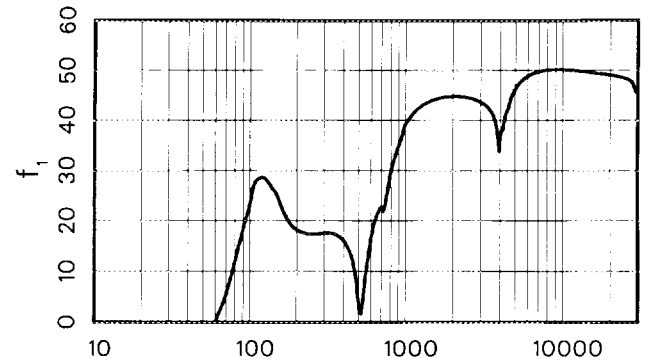

Edge Energies

K	29200.1 eV	L _I	4464.7 eV	M _I	884.7 eV ^b	N _I	137.1 eV ^b
		L _{II}	4156.1 eV	M _{II}	756.5 eV ^b	N _{II}	83.6 eV ^b
		L _{III}	3928.8 eV	M _{III}	714.6 eV ^b	N _{III}	83.6 eV ^b
				M _{IV}	493.2 eV ^b	N _{IV}	24.9 eV ^b
				M _V	484.9 eV ^b	N _V	23.9 eV ^b

References: 1, 2, 4, 12, 17, 21, 24, 33, 52, 58, 95, 96, 99, 101, 110, 122, 131, 175, 198, 216, 229.

TABLE I. Photoabsorption Cross Sections and Atomic Scattering Factors,
 $Z = 1-92$, $E = 50-30,000$ eV
 See page 211 for Explanation of Tables

μ_a (barns/atom) = μ (cm²/gm) \times 202.19
 E (keV) μ (cm²/gm) = $f_2 \times 345.59$

Antimony (Sb)
 $Z = 51$
 Atomic Weight = 121.757

Line	E(eV)	μ (cm ² /gm)	f_1	f_2	λ (Å)
H	10.2	3.41e + 5		10.06	1215
He I	21.2	1.89e + 4		1.16	584.3
Na L _{2,3}	30.5	6.34e + 3		0.56	407.2
Mg L _{2,3}	49.3	5.50e + 4		7.85	251.5
Al L _{2,3}	72.4	1.08e + 5	3.63	22.55	171.2
Si L _{2,3}	91.5	9.46e + 4	19.89	25.04	135.5
Be K	108.5	5.14e + 4	29.69	16.13	114.3
Sr M ζ	114.0	3.63e + 4	30.04	11.96	108.8
Y M ζ	132.8	7.84e + 3	25.36	3.01	93.4
Zr M ζ	151.1	4.93e + 3	20.70	2.15	82.1
B K α	183.3	6.85e + 3	18.00	3.63	67.6
Mo M ζ	192.6	7.03e + 3	17.74	3.92	64.4
Ar L ℓ	220.1	7.03e + 3	17.30	4.48	56.3
C K α	277.0	6.57e + 3	16.77	5.27	44.8
Ag M ζ	311.7	6.01e + 3	16.44	5.42	39.8
N K α	392.4	5.00e + 3	14.53	5.68	31.6
Ti L α	452.2	4.19e + 3	10.89	5.48	27.4
V L α	511.3	3.54e + 3	-3.83	5.24	24.2
O K α	524.9	7.83e + 3	-12.58	11.89	23.6
Cr L α	572.8	2.18e + 4	13.22	36.13	21.6
Mn L α	637.4	1.70e + 4	24.16	31.36	19.5
F K α	676.8	1.47e + 4	27.15	28.79	18.3
Fe L α	705.0	1.35e + 4	28.41	27.48	17.6
Co L α	776.2	1.12e + 4	29.52	25.05	16.0
Ni L α	851.5	1.11e + 4	32.09	27.37	14.6
Cu L α	929.7	9.54e + 3	36.11	25.67	13.3
Zn L α	1011.7	8.41e + 3	38.97	24.62	12.3
Na K α	1041.0	7.92e + 3	40.09	23.85	11.9
Ge L α	1188.0	5.86e + 3	43.04	20.14	10.4
Mg K α	1253.6	5.18e + 3	43.80	18.80	9.9
Al K α	1486.7	3.51e + 3	45.40	15.12	8.3
Si K α	1740.0	2.43e + 3	46.15	12.25	7.1
Zr L α	2042.4	1.66e + 3	46.39	9.83	6.1
Mo L α	2293.2	1.26e + 3	46.34	8.35	5.4
Cl K α	2622.4	9.04e + 2	46.04	6.86	4.7
Ag L α	2984.3	6.53e + 2	45.47	5.64	4.2
Ca K α	3691.7	3.74e + 2	43.12	3.99	3.4
Ti K α	4510.8	9.52e + 2	42.04	12.42	2.7
V K α	4952.2	8.63e + 2	45.97	12.36	2.5
Cr K α	5414.7	6.88e + 2	48.21	10.78	2.3
Mn K α	5898.8	5.52e + 2	49.40	9.42	2.1
Co K α	6930.3	3.62e + 2	50.55	7.26	1.8
Ni K α	7478.2	2.96e + 2	50.81	6.40	1.7
Cu K α	8047.8	2.43e + 2	50.97	5.66	1.5
Ge K α	9886.4	1.40e + 2	51.06	3.99	1.3
Y K α	14988.0	4.48e + 1	50.62	1.94	0.8
Mo K α	17479.0	2.93e + 1	50.37	1.48	0.7
Pd K α	21177.0	1.72e + 1	50.02	1.06	0.6
Sn K α	25271.0	1.06e + 1	49.52	0.77	0.5
Xe K α	29779.0	6.68e + 0	48.20	0.58	0.4

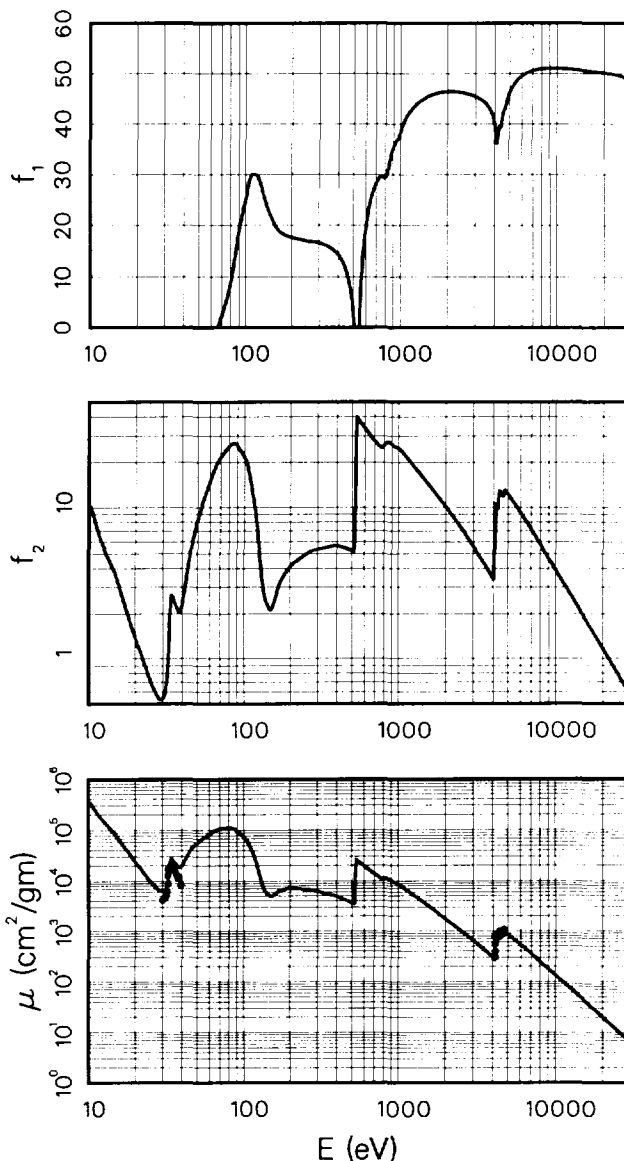

Edge Energies

L _I	4698.3 eV	M _I	946. eV ^b	N _I	153.2 eV ^b
L _{II}	4380.4 eV	M _{II}	812.7 eV ^b	N _{II}	95.6 eV ^b
L _{III}	4132.2 eV	M _{III}	766.4 eV ^b	N _{III}	95.6 eV ^b
		M _{IV}	537.5 eV ^b	N _{IV}	33.3 eV ^b
		M _V	528.2 eV ^b	N _V	32.1 eV ^b

References: 58, 208.

TABLE I. Photoabsorption Cross Sections and Atomic Scattering Factors,
 $Z = 1-92$, $E = 50-30,000$ eV
 See page 211 for Explanation of Tables

$$\mu_a(\text{barns/atom}) = \mu(\text{cm}^2/\text{gm}) \times 211.89$$

$$E(\text{keV})\mu(\text{cm}^2/\text{gm}) = f_2 \times 329.77$$

Tellurium (Te)
 $Z = 52$
 Atomic Weight = 127.600

Line	E(eV)	$\mu(\text{cm}^2/\text{gm})$	f_1	f_2	λ (Å)
H	10.2	3.15e+5		9.73	1215
He I	21.2	4.47e+4		2.87	584.3
Na L _{2,3}	30.5	8.50e+3		0.78	407.2
Mg L _{2,3}	49.3	2.36e+4		3.53	251.5
Al L _{2,3}	72.4	9.08e+4	-3.10	19.94	171.2
Si L _{2,3}	91.5	1.12e+5	10.89	31.01	135.5
Be K	108.5	7.40e+4	30.62	24.35	114.3
Sr M ζ	114.0	5.39e+4	32.73	18.65	108.8
Y M ζ	132.8	1.28e+4	28.46	5.16	93.4
Zr M ζ	151.1	4.93e+3	22.74	2.26	82.1
B K α	183.3	5.24e+3	18.15	2.91	67.6
Mo M ζ	192.6	5.75e+3	17.48	3.36	64.4
Ar L ℓ	220.1	7.01e+3	16.48	4.68	56.3
C K α	277.0	7.75e+3	16.39	6.51	44.8
Ag M ζ	311.7	7.42e+3	16.55	7.01	39.8
N K α	392.4	5.96e+3	16.60	7.09	31.6
Ti L α	452.2	4.68e+3	14.51	6.41	27.4
V L α	511.3	4.01e+3	9.43	6.22	24.2
O K α	524.9	3.94e+3	7.27	6.28	23.6
Cr L α	572.8	1.33e+4	-13.88	23.09	21.6
Mn L α	637.4	1.75e+4	17.43	33.78	19.5
F K α	676.8	1.56e+4	22.36	32.02	18.3
Fe L α	705.0	1.44e+4	25.03	30.74	17.6
Co L α	776.2	1.18e+4	28.19	27.80	16.0
Ni L α	851.5	1.13e+4	30.73	29.18	14.6
Cu L α	929.7	9.81e+3	35.23	27.65	13.3
Zn L α	1011.7	8.62e+3	38.35	26.45	12.3
Na K α	1041.0	8.12e+3	39.60	25.64	11.9
Ge L α	1188.0	6.03e+3	42.94	21.71	10.4
Mg K α	1253.6	5.34e+3	43.82	20.29	9.9
Al K α	1486.7	3.63e+3	45.73	16.37	8.3
Si K α	1740.0	2.51e+3	46.69	13.25	7.1
Zr L α	2042.4	1.70e+3	47.04	10.55	6.1
Mo L α	2293.2	1.28e+3	47.00	8.89	5.4
Cl K α	2622.4	9.12e+2	46.67	7.26	4.7
Ag L α	2984.3	6.57e+2	46.07	5.95	4.2
Ca K α	3691.7	3.82e+2	44.04	4.27	3.4
Ti K α	4510.8	7.83e+2	39.33	10.71	2.7
V K α	4952.2	9.00e+2	43.71	13.51	2.5
Cr K α	5414.7	7.71e+2	47.67	12.66	2.3
Mn K α	5898.8	6.22e+2	49.48	11.13	2.1
Co K α	6930.3	4.11e+2	51.23	8.64	1.8
Ni K α	7478.2	3.37e+2	51.66	7.63	1.7
Cu K α	8047.8	2.77e+2	51.92	6.76	1.5
Ge K α	9886.4	1.59e+2	52.20	4.78	1.3
Y K α	14988.0	5.08e+1	51.81	2.31	0.8
Mo K α	17479.0	3.32e+1	51.56	1.76	0.7
Pd K α	21177.0	1.95e+1	51.20	1.25	0.6
Sn K α	25271.0	1.19e+1	50.76	0.91	0.5
Xe K α	29779.0	7.58e+0	49.91	0.68	0.4

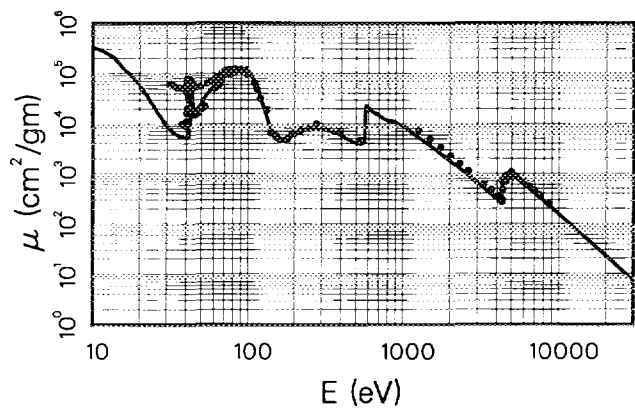
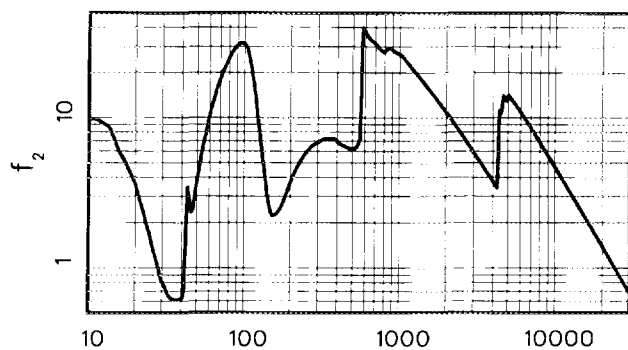
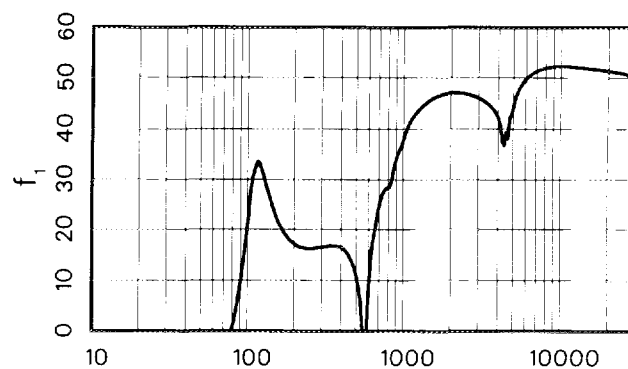

Edge Energies

L _I	4939.2 eV	M _I	1006. eV ^b	N _I	169.4 eV ^b
L _{II}	4612.0 eV	M _{II}	870.8 eV ^b	N _{II}	103.3 eV ^b
L _{III}	4341.4 eV	M _{III}	820.0 eV ^b	N _{III}	103.3 eV ^b
		M _{IV}	583.4 eV ^b	N _{IV}	41.9 eV ^b
		M _V	573.0 eV ^b	N _V	40.4 eV ^b

References: 24, 25, 39, 58, 101, 102, 173.

TABLE I. Photoabsorption Cross Sections and Atomic Scattering Factors.

Z = 1-92, E = 50-30,000 eV

See page 211 for Explanation of Tables

Iodine (I)

Z = 53

Atomic Weight = 126.904

$$\mu_a(\text{barns/atom}) = \mu(\text{cm}^2/\text{gm}) \times 210.73$$

$$E(\text{keV})\mu(\text{cm}^2/\text{gm}) = f_2 \times 331.57$$

Line	E(eV)	$\mu(\text{cm}^2/\text{gm})$	f_1	f_2	$\lambda(\text{\AA})$
H	10.2	2.44e+5		7.51	1215
He I	21.2	8.62e+4		5.52	584.3
Na L _{2,3}	30.5	1.90e+4		1.74	407.2
Mg L _{2,3}	49.3	3.72e+4		5.54	251.5
Al L _{2,3}	72.4	6.09e+4	-6.00	13.29	171.2
Si L _{2,3}	91.5	1.10e+5	5.94	30.26	135.5
Be K	108.5	8.71e+4	24.98	28.50	114.3
Sr M ζ	114.0	6.87e+4	29.52	23.63	108.8
Y M ζ	132.8	2.82e+4	30.61	11.29	93.4
Zr M ζ	151.1	1.20e+4	27.71	5.49	82.1
B K α	183.3	4.36e+3	21.66	2.41	67.6
Mo M ζ	192.6	4.54e+3	20.55	2.64	64.4
Ar L ℓ	220.1	5.63e+3	18.65	3.74	56.3
C K α	277.0	7.32e+3	17.74	6.12	44.8
Ag M ζ	311.7	7.36e+3	18.19	6.92	39.8
N K α	392.4	6.08e+3	18.52	7.19	31.6
Ti L α	452.2	5.04e+3	17.66	6.87	27.4
V L α	511.3	4.15e+3	15.29	6.40	24.2
O K α	524.9	3.97e+3	14.37	6.29	23.6
Cr L α	572.8	3.44e+3	8.70	5.95	21.6
Mn L α	637.4	2.03e+4	0.11	39.11	19.5
F K α	676.8	1.73e+4	17.59	35.24	18.3
Fe L α	705.0	1.56e+4	22.10	33.23	17.6
Co L α	776.2	1.24e+4	28.09	29.10	16.0
Ni L α	851.5	1.04e+4	29.47	26.65	14.6
Cu L α	929.7	1.05e+4	32.73	29.45	13.3
Zn L α	1011.7	8.88e+3	37.71	27.11	12.3
Na K α	1041.0	8.37e+3	38.64	26.29	11.9
Ge L α	1188.0	6.47e+3	42.18	23.17	10.4
Mg K α	1253.6	5.81e+3	43.45	21.97	9.9
Al K α	1486.7	3.96e+3	46.17	17.77	8.3
Si K α	1740.0	2.76e+3	47.43	14.47	7.1
Zr L α	2042.4	1.89e+3	48.01	11.67	6.1
Mo L α	2293.2	1.44e+3	48.15	9.95	5.4
Cl K α	2622.4	1.04e+3	48.05	8.23	4.7
Ag L α	2984.3	7.58e+2	47.69	6.82	4.2
Ca K α	3691.7	4.43e+2	46.31	4.93	3.4
Ti K α	4510.8	2.62e+2	37.08	3.56	2.7
V K α	4952.2	8.69e+2	42.74	12.98	2.5
Cr K α	5414.7	8.01e+2	47.42	13.09	2.3
Mn K α	5898.8	6.45e+2	49.91	11.47	2.1
Co K α	6930.3	4.24e+2	51.99	8.87	1.8
Ni K α	7478.2	3.47e+2	52.48	7.83	1.7
Cu K α	8047.8	2.86e+2	52.79	6.93	1.5
Ge K α	9886.4	1.64e+2	53.12	4.90	1.3
Y K α	14988.0	5.29e+1	52.80	2.39	0.8
Mo K α	17479.0	3.46e+1	52.57	1.83	0.7
Pd K α	21177.0	2.04e+1	52.23	1.30	0.6
Sn K α	25271.0	1.25e+1	51.84	0.95	0.5
Xe K α	29779.0	7.90e+0	51.20	0.71	0.4

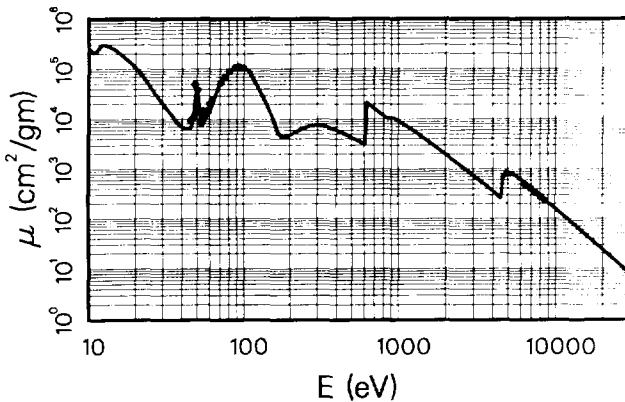
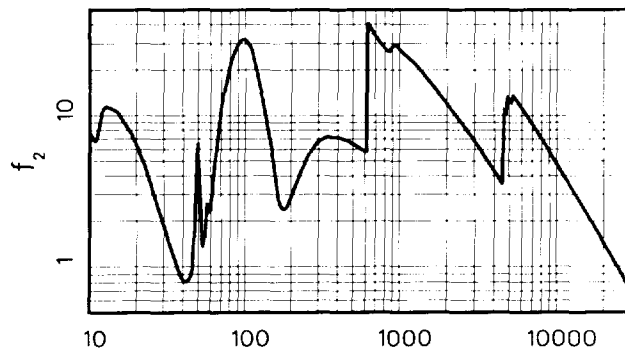
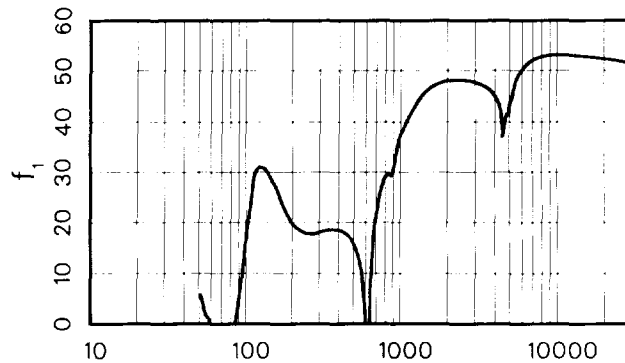

Edge Energies

L _I	5188.1 eV	M _I	1072. eV ^a	N _I	186. eV ^a
L _{II}	4852.1 eV	M _{II}	931. eV ^a	N _{II}	123. eV ^a
L _{III}	4557.1 eV	M _{III}	875. eV ^a	N _{III}	123. eV ^a
		M _{IV}	631. eV ^a	N _{IV}	50. eV ^a
		M _V	620. eV ^a	N _V	50. eV ^a

References: 29, 165.

TABLE I. Photoabsorption Cross Sections and Atomic Scattering Factors,
 $Z = 1-92, E = 50-30,000 \text{ eV}$
 See page 211 for Explanation of Tables

$\mu_a(\text{barns/atom}) = \mu(\text{cm}^2/\text{gm}) \times 218.02$
 $E(\text{keV})\mu(\text{cm}^2/\text{gm}) = f_2 \times 320.50$

Xenon (Xe)
 $Z = 54$
 Atomic Weight = 131.290

Line	E(eV)	$\mu(\text{cm}^2/\text{gm})$	f_1	f_2	$\lambda(\text{\AA})$
H	10.2				1215
He I	21.2	1.38e + 5		9.17	584.3
Na L _{2,3}	30.5	3.31e + 4		3.15	407.2
Mg L _{2,3}	49.3	6.35e + 3		0.98	251.5
Al L _{2,3}	72.4	3.35e + 4	-7.76	7.57	171.2
Si L _{2,3}	91.5	1.15e + 5	-2.61	32.92	135.5
Be K	108.5	1.12e + 5	22.31	37.99	114.3
Sr M ζ	114.0	9.53e + 4	30.16	33.90	108.8
Y M ζ	132.8	3.22e + 4	35.98	13.36	93.4
Zr M ζ	151.1	1.10e + 4	30.40	5.20	82.1
B K α	183.3	4.17e + 3	22.81	2.38	67.6
Mo M ζ	192.6	4.30e + 3	21.58	2.58	64.4
Ar L ℓ	220.1	5.55e + 3	19.29	3.81	56.3
C K α	277.0	7.58e + 3	18.48	6.55	44.8
Ag M ζ	311.7	7.52e + 3	19.03	7.31	39.8
N K α	392.4	6.34e + 3	19.53	7.77	31.6
Ti L α	452.2	5.52e + 3	19.37	7.78	27.4
V L α	511.3	4.58e + 3	18.37	7.31	24.2
O K α	524.9	4.40e + 3	17.94	7.21	23.6
Cr L α	572.8	3.86e + 3	15.59	6.91	21.6
Mn L α	637.4	3.28e + 3	7.77	6.53	19.5
F K α	676.8	1.66e + 4	-16.30	35.04	18.3
Fe L α	705.0	1.71e + 4	8.85	37.62	17.6
Co L α	776.2	1.34e + 4	24.12	32.53	16.0
Ni L α	851.5	1.08e + 4	29.02	28.59	14.6
Cu L α	929.7	9.78e + 3	29.17	28.38	13.3
Zn L α	1011.7	9.27e + 3	35.16	29.25	12.3
Na K α	1041.0	8.78e + 3	36.55	28.50	11.9
Ge L α	1188.0	6.84e + 3	41.24	25.35	10.4
Mg K α	1253.6	6.17e + 3	42.87	24.12	9.9
Al K α	1486.7	4.20e + 3	46.27	19.49	8.3
Si K α	1740.0	2.94e + 3	47.86	15.98	7.1
Zr L α	2042.4	2.03e + 3	48.72	12.96	6.1
Mo L α	2293.2	1.55e + 3	49.02	11.08	5.4
Cl K α	2622.4	1.12e + 3	49.06	9.19	4.7
Ag L α	2984.3	8.19e + 2	48.83	7.63	4.2
Ca K α	3691.7	4.79e + 2	47.75	5.52	3.4
Ti K α	4510.8	2.82e + 2	44.33	3.97	2.7
V K α	4952.2	6.87e + 2	40.89	10.61	2.5
Cr K α	5414.7	7.41e + 2	45.16	12.51	2.3
Mn K α	5898.8	6.89e + 2	49.60	12.67	2.1
Co K α	6930.3	4.55e + 2	52.51	9.84	1.8
Ni K α	7478.2	3.73e + 2	53.18	8.70	1.7
Cu K α	8047.8	3.07e + 2	53.61	7.72	1.5
Ge K α	9886.4	1.77e + 2	54.12	5.47	1.3
Y K α	14988.0	5.71e + 1	53.90	2.67	0.8
Mo K α	17479.0	3.74e + 1	53.67	2.04	0.7
Pd K α	21177.0	2.20e + 1	53.34	1.46	0.6
Sn K α	25271.0	1.35e + 1	52.97	1.06	0.5
Xe K α	29779.0	8.55e + 0	52.45	0.79	0.4

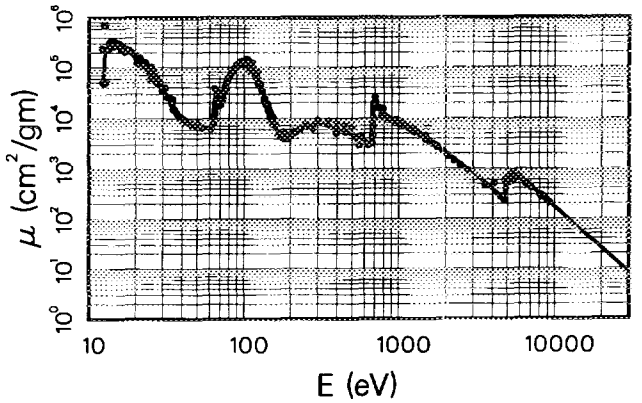
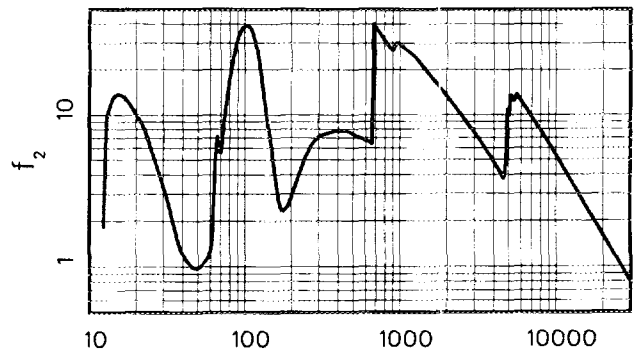
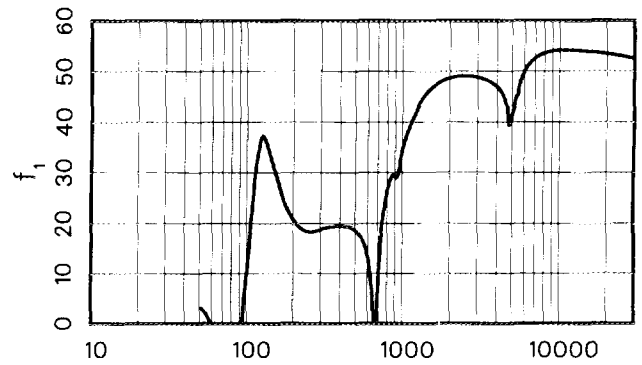

Edge Energies

L _I	5452.8 eV	M _I	1148.7 eV ^a	N _I	213.2 eV ^a	O _I	23.3 eV ^a
L _{II}	5103.7 eV	M _{II}	1002.1 eV ^a	N _{II}	146.7 eV	O _{II}	13.4 eV ^a
L _{III}	4782.2 eV	M _{III}	940.6 eV ^a	N _{III}	145.5 eV ^a	O _{III}	12.1 eV ^a
		M _{IV}	689.0 eV ^a	N _{IV}	69.5 eV ^a		
		M _V	676.4 eV ^a	N _V	67.5 eV ^a		

References: 11, 22, 74, 82, 89, 93, 97, 101, 111, 118, 137, 140, 151, 153, 186, 218.

TABLE I. Photoabsorption Cross Sections and Atomic Scattering Factors,
 $Z = 1-92$, $E = 50-30,000$ eV
 See page 211 for Explanation of Tables

μ_a (barns/atom) = μ (cm²/gm) \times 220.70
 E (keV) μ (cm²/gm) = $f_2 \times 316.60$

Cesium (Cs)
 $Z = 55$
 Atomic Weight = 132.905

Line	E(eV)	μ (cm ² /gm)	f_1	f_2	λ (Å)
H	10.2	1.30e + 3		0.04	1215
He I	21.2	1.83e + 5		12.27	584.3
Na L _{2,3}	30.5	4.81e + 4		4.63	407.2
Mg L _{2,3}	49.3	6.70e + 3		1.04	251.5
Al L _{2,3}	72.4	7.81e + 3	-2.10	1.79	171.2
Si L _{2,3}	91.5	9.53e + 4	-9.76	27.54	135.5
Be K	108.5	1.25e + 5	16.41	42.82	114.3
Sr M ζ	114.0	1.16e + 5	26.92	41.62	108.8
Y M ζ	132.8	4.27e + 4	41.06	17.89	93.4
Zr M ζ	151.1	1.18e + 4	34.73	5.61	82.1
B K α	183.3	3.91e + 3	26.17	2.27	67.6
Mo M ζ	192.6	4.02e + 3	24.84	2.45	64.4
Ar L l	220.1	4.69e + 3	22.33	3.26	56.3
C K α	277.0	6.50e + 3	20.88	5.69	44.8
Ag M ζ	311.7	6.78e + 3	21.07	6.67	39.8
N K α	392.4	6.15e + 3	21.91	7.62	31.6
Ti L α	452.2	5.36e + 3	22.21	7.65	27.4
V L α	511.3	4.59e + 3	21.74	7.41	24.2
O K α	524.9	4.44e + 3	21.55	7.36	23.6
Cr L α	572.8	3.92e + 3	20.46	7.10	21.6
Mn L α	637.4	3.34e + 3	17.31	6.73	19.5
F K α	676.8	3.03e + 3	13.14	6.48	18.3
Fe L α	705.0	2.85e + 3	4.88	6.35	17.6
Co L α	776.2	1.36e + 4	18.30	33.23	16.0
Ni L α	851.5	1.08e + 4	27.55	29.17	14.6
Cu L α	929.7	8.92e + 3	30.91	26.19	13.3
Zn L α	1011.7	9.27e + 3	30.14	29.62	12.3
Na K α	1041.0	8.71e + 3	34.27	28.63	11.9
Ge L α	1188.0	6.77e + 3	40.25	25.40	10.4
Mg K α	1253.6	6.06e + 3	41.85	23.99	9.9
Al K α	1486.7	4.37e + 3	45.47	20.52	8.3
Si K α	1740.0	3.12e + 3	48.20	17.12	7.1
Zr L α	2042.4	2.14e + 3	49.50	13.78	6.1
Mo L α	2293.2	1.62e + 3	49.94	11.71	5.4
Cl K α	2622.4	1.17e + 3	50.08	9.67	4.7
Ag L α	2984.3	8.50e + 2	49.91	8.01	4.2
Ca K α	3691.7	5.00e + 2	49.02	5.83	3.4
Ti K α	4510.8	3.01e + 2	46.61	4.29	2.7
V K α	4952.2	4.15e + 2	41.02	6.50	2.5
Cr K α	5414.7	7.44e + 2	44.47	12.72	2.3
Mn K α	5898.8	7.13e + 2	48.92	13.29	2.1
Co K α	6930.3	4.77e + 2	52.89	10.44	1.8
Ni K α	7478.2	3.92e + 2	53.75	9.27	1.7
Cu K α	8047.8	3.24e + 2	54.30	8.24	1.5
Ge K α	9886.4	1.88e + 2	55.03	5.87	1.3
Y K α	14988.0	6.04e + 1	54.94	2.86	0.8
Mo K α	17479.0	3.95e + 1	54.72	2.18	0.7
Pd K α	21177.0	2.32e + 1	54.40	1.55	0.6
Sn K α	25271.0	1.42e + 1	54.05	1.13	0.5
Xe K α	29779.0	9.01e + 0	53.60	0.85	0.4

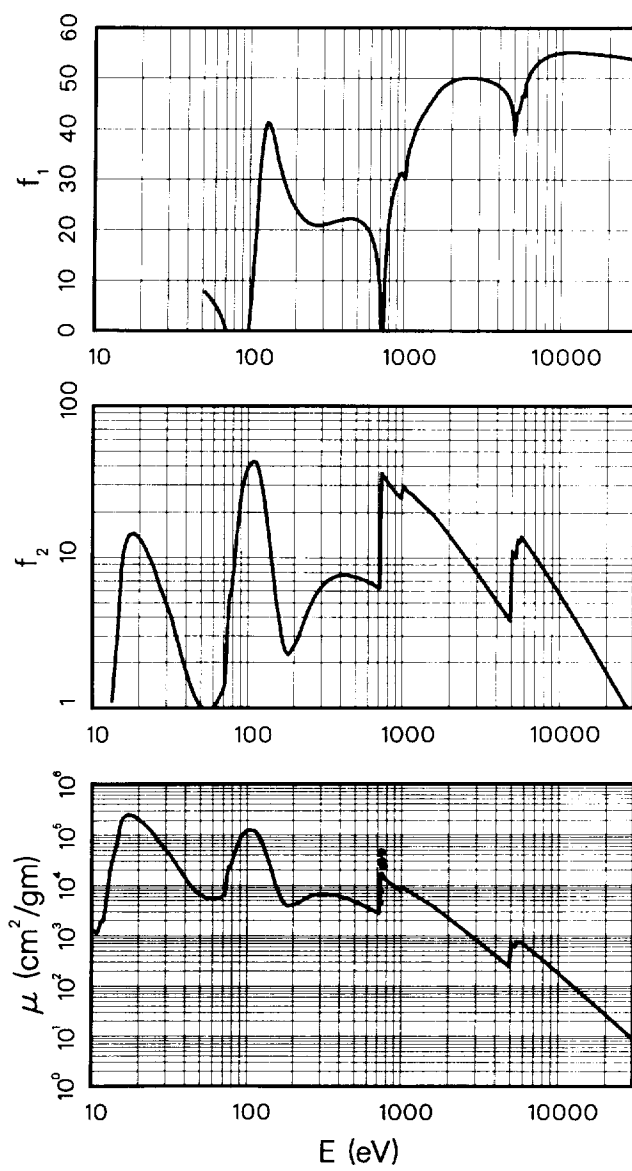

Edge Energies

L _I	5714.3 eV	M _I	1211. eV ^a	N _I	232.3 eV ^a	O _I	22.7 eV
L _{II}	5359.4 eV	M _{II}	1071. eV ^a	N _{II}	172.4 eV ^a	O _{II}	14.2 eV ^a
L _{III}	5011.9 eV	M _{III}	1003. eV ^a	N _{III}	161.3 eV ^a	O _{III}	12.1 eV ^a
		M _{IV}	740.5 eV ^a	N _{IV}	79.8 eV ^a		
		M _V	726.6 eV ^a	N _V	77.5 eV ^a		

References: 157.

TABLE I. Photoabsorption Cross Sections and Atomic Scattering Factors,
 $Z = 1-92$, $E = 50-30,000$ eV
 See page 211 for Explanation of Tables

$\mu_a(\text{barns/atom}) = \mu(\text{cm}^2/\text{gm}) \times 228.04$
 $E(\text{keV})\mu(\text{cm}^2/\text{gm}) = f_2 \times 306.41$

Barium (Ba)
 $Z = 56$
 Atomic Weight = 137.327

Line	E(eV)	$\mu(\text{cm}^2/\text{gm})$	f_1	f_2	λ (Å)
H	10.2	3.27e + 3		0.11	1215
He I	21.2	3.61e + 5		25.00	584.3
Na L _{2,3}	30.5	7.95e + 4		7.90	407.2
Mg L _{2,3}	49.3	8.24e + 3		1.33	251.5
Al L _{2,3}	72.4	6.07e + 3	5.23	1.43	171.2
Si L _{2,3}	91.5	1.66e + 4	-8.59	4.96	135.5
Be K	108.5	1.61e + 5	-1.08	57.15	114.3
Sr M ζ	114.0	1.49e + 5	14.59	55.59	108.8
Y M ζ	132.8	5.09e + 4	44.76	22.07	93.4
Zr M ζ	151.1	1.41e + 4	37.27	6.95	82.1
B K α	183.3	3.25e + 3	26.95	1.94	67.6
Mo M ζ	192.6	3.33e + 3	25.24	2.09	64.4
Ar L l	220.1	4.36e + 3	22.31	3.13	56.3
C K α	277.0	6.80e + 3	20.58	6.15	44.8
Ag M ζ	311.7	7.28e + 3	20.93	7.41	39.8
N K α	392.4	6.52e + 3	22.50	8.35	31.6
Ti L α	452.2	5.67e + 3	22.98	8.37	27.4
V L α	511.3	4.95e + 3	23.05	8.25	24.2
O K α	524.9	4.79e + 3	23.05	8.20	23.6
Cr L α	572.8	4.13e + 3	22.63	7.73	21.6
Mn L α	637.4	3.48e + 3	20.92	7.24	19.5
F K α	676.8	3.15e + 3	19.14	6.95	18.3
Fe L α	705.0	2.92e + 3	17.05	6.72	17.6
Co L α	776.2	2.69e + 3	-2.31	6.81	16.0
Ni L α	851.5	1.12e + 4	19.53	31.01	14.6
Cu L α	929.7	9.86e + 3	26.97	29.91	13.3
Zn L α	1011.7	8.71e + 3	31.59	28.76	12.3
Na K α	1041.0	8.36e + 3	32.89	28.39	11.9
Ge L α	1188.0	6.86e + 3	37.99	26.62	10.4
Mg K α	1253.6	6.33e + 3	39.81	25.91	9.9
Al K α	1486.7	4.64e + 3	45.27	22.51	8.3
Si K α	1740.0	3.30e + 3	48.23	18.74	7.1
Zr L α	2042.4	2.30e + 3	49.88	15.34	6.1
Mo L α	2293.2	1.76e + 3	50.57	13.16	5.4
Cl K α	2622.4	1.28e + 3	50.96	10.96	4.7
Ag L α	2984.3	9.36e + 2	51.00	9.12	4.2
Ca K α	3691.7	5.51e + 2	50.40	6.64	3.4
Ti K α	4510.8	3.27e + 2	48.60	4.81	2.7
V K α	4952.2	2.54e + 2	46.17	4.10	2.5
Cr K α	5414.7	6.05e + 2	44.05	10.69	2.3
Mn K α	5898.8	6.63e + 2	47.66	12.76	2.1
Co K α	6930.3	5.03e + 2	53.16	11.38	1.8
Ni K α	7478.2	4.15e + 2	54.29	10.13	1.7
Cu K α	8047.8	3.44e + 2	55.01	9.03	1.5
Ge K α	9886.4	2.00e + 2	55.99	6.45	1.3
Y K α	14988.0	6.43e + 1	56.03	3.15	0.8
Mo K α	17479.0	4.20e + 1	55.81	2.40	0.7
Pd K α	21177.0	2.46e + 1	55.50	1.70	0.6
Sn K α	25271.0	1.50e + 1	55.15	1.24	0.5
Xe K α	29779.0	9.54e + 0	54.75	0.93	0.4

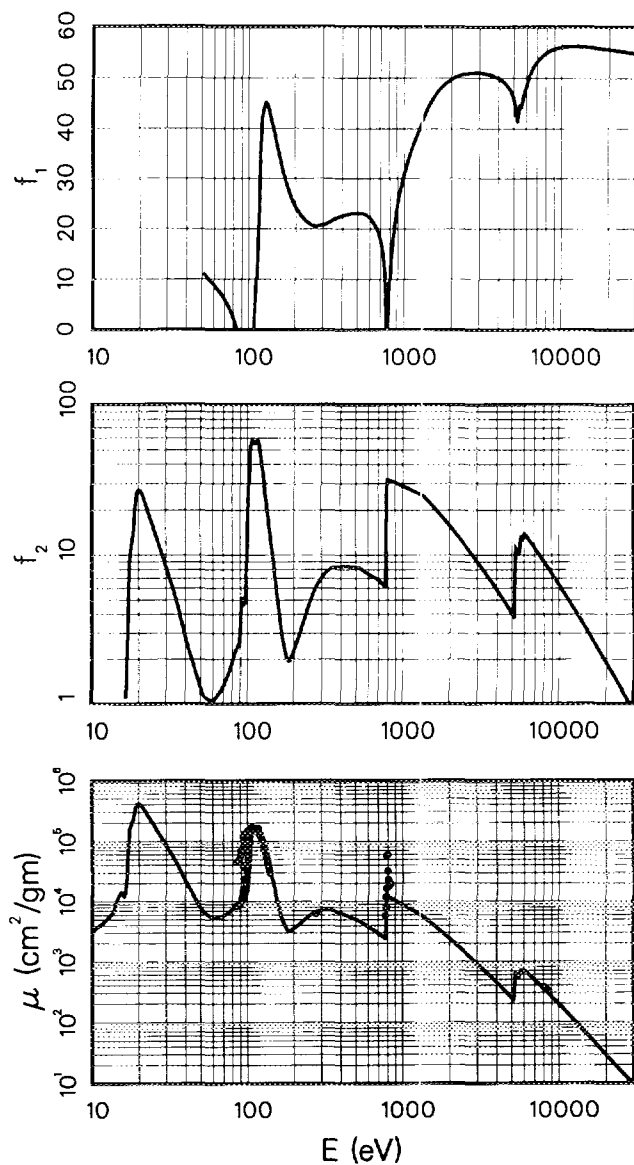

Edge Energies

L _I	5988.8 eV	M _I	1293. eV ^a	N _I	253.5 eV ^b	O _I	30.3 eV ^b
L _{II}	5623.6 eV	M _{II}	1137. eV ^a	N _{II}	192. eV	O _{II}	17.0 eV ^b
L _{III}	5247.0 eV	M _{III}	1063. eV ^a	N _{III}	178.6 eV ^b	O _{III}	14.8 eV ^b
		M _{IV}	795.5 eV ^b	N _{IV}	92.6 eV ^b		
		M _V	780.2 eV ^b	N _V	89.9 eV ^b		

References: 127, 157, 179, 224.

TABLE I. Photoabsorption Cross Sections and Atomic Scattering Factors,
 $Z = 1-92$, $E = 50-30,000$ eV
 See page 211 for Explanation of Tables

μ_a (barns/atom) = μ (cm²/gm) \times 230.66
 E (keV) μ (cm²/gm) = $f_2 \times 302.93$

Lanthanum (La)
 $Z = 57$
 Atomic Weight = 138.906

Line	E(eV)	μ (cm ² /gm)	f_1	f_2	λ (Å)
H	10.2	3.76e + 4		1.27	1215
He I	21.2	7.53e + 4		5.28	584.3
Na L _{2,3}	30.5	1.44e + 5		14.50	407.2
Mg L _{2,3}	49.3	1.66e + 4		2.70	251.5
Al L _{2,3}	72.4	6.06e + 3	7.07	1.45	171.2
Si L _{2,3}	91.5	9.14e + 3	-1.44	2.76	135.5
Be K	108.5	3.25e + 4	-25.93	11.63	114.3
Sr M ζ	114.0	1.19e + 5	-50.44	44.91	108.8
Y M ζ	132.8	8.58e + 4	52.22	37.63	93.4
Zr M ζ	151.1	2.17e + 4	43.33	10.83	82.1
B K α	183.3	3.40e + 3	30.23	2.06	67.6
Mo M ζ	192.6	3.09e + 3	27.96	1.97	64.4
Ar L l	220.1	4.09e + 3	23.94	2.97	56.3
C K α	277.0	6.61e + 3	21.59	6.04	44.8
Ag M ζ	311.7	7.17e + 3	21.79	7.38	39.8
N K α	392.4	6.85e + 3	22.98	8.87	31.6
Ti L α	452.2	6.33e + 3	23.89	9.44	27.4
V L α	511.3	5.51e + 3	24.75	9.29	24.2
O K α	524.9	5.29e + 3	24.87	9.17	23.6
Cr L α	572.8	4.58e + 3	24.89	8.67	21.6
Mn L α	637.4	3.76e + 3	24.03	7.90	19.5
F K α	676.8	3.39e + 3	22.99	7.59	18.3
Fe L α	705.0	3.16e + 3	21.96	7.36	17.6
Co L α	776.2	2.61e + 3	16.75	6.68	16.0
Ni L α	851.5	1.21e + 4	5.35	34.15	14.6
Cu L α	929.7	9.59e + 3	25.47	29.43	13.3
Zn L α	1011.7	8.26e + 3	29.50	27.58	12.3
Na K α	1041.0	7.96e + 3	30.68	27.37	11.9
Ge L α	1188.0	6.92e + 3	35.73	27.13	10.4
Mg K α	1253.6	6.52e + 3	38.12	26.99	9.9
Al K α	1486.7	4.90e + 3	44.52	24.06	8.3
Si K α	1740.0	3.48e + 3	48.27	20.01	7.1
Zr L α	2042.4	2.43e + 3	50.26	16.40	6.1
Mo L α	2293.2	1.87e + 3	51.12	14.14	5.4
Cl K α	2622.4	1.37e + 3	51.68	11.84	4.7
Ag L α	2984.3	1.01e + 3	51.86	9.91	4.2
Ca K α	3691.7	5.96e + 2	51.52	7.27	3.4
Ti K α	4510.8	3.55e + 2	50.14	5.28	2.7
V K α	4952.2	2.75e + 2	48.56	4.49	2.5
Cr K α	5414.7	2.13e + 2	40.87	3.81	2.3
Mn K α	5898.8	5.29e + 2	45.32	10.30	2.1
Co K α	6930.3	5.40e + 2	53.26	12.34	1.8
Ni K α	7478.2	4.44e + 2	54.74	10.97	1.7
Cu K α	8047.8	3.68e + 2	55.65	9.77	1.5
Ge K α	9886.4	2.14e + 2	56.88	6.98	1.3
Y K α	14988.0	6.92e + 1	57.06	3.43	0.8
Mo K α	17479.0	4.54e + 1	56.86	2.62	0.7
Pd K α	21177.0	2.67e + 1	56.56	1.87	0.6
Sn K α	25271.0	1.64e + 1	56.23	1.37	0.5
Xe K α	29779.0	1.04e + 1	55.87	1.02	0.4

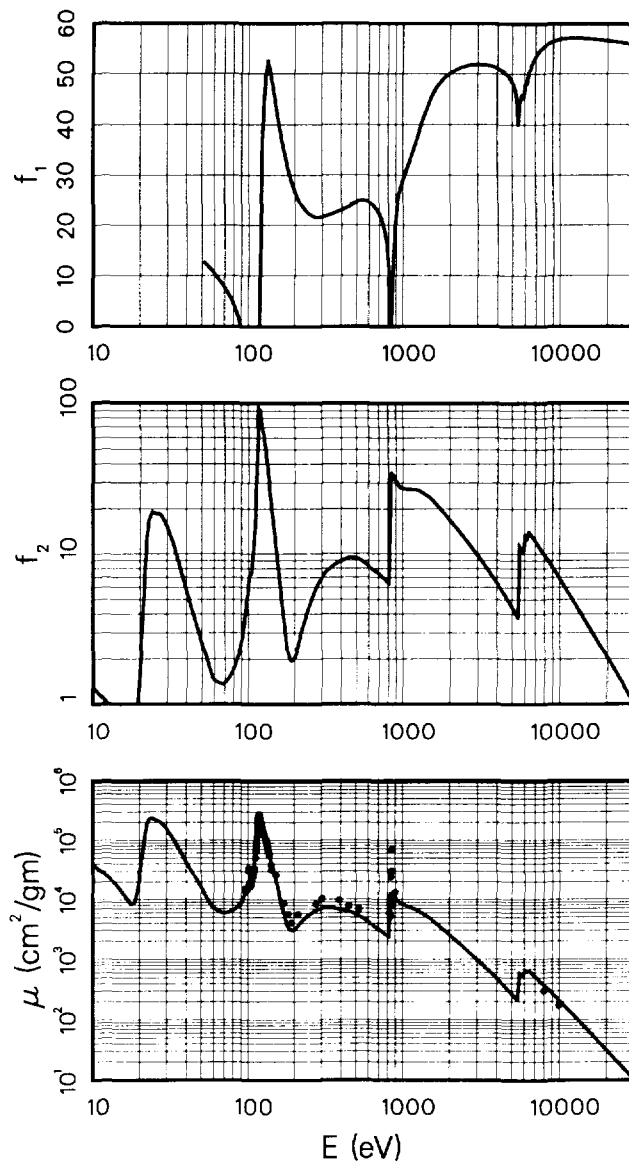

Edge Energies

L _I	6266.3 eV	M _I	1362. eV ^a	N _I	274.7 eV ^a	O _I	34.3 eV ^a
L _{II}	5890.6 eV	M _{II}	1209. eV ^a	N _{II}	205.8 eV	O _{II}	19.3 eV ^a
L _{III}	5482.7 eV	M _{III}	1128. eV ^a	N _{III}	196.0 eV ^a	O _{III}	16.8 eV ^a
		M _{IV}	853. eV ^a	N _{IV}	105.3 eV ^a		
		M _V	836. eV ^a	N _V	102.5 eV ^a		

References: 116, 131, 157.

TABLE I. Photoabsorption Cross Sections and Atomic Scattering Factors.
 $Z = 1-92$, $E = 50-30,000$ eV
 See page 211 for Explanation of Tables

$\mu_a(\text{barns/atom}) = \mu(\text{cm}^2/\text{gm}) \times 232.67$
 $E(\text{keV})\mu(\text{cm}^2/\text{gm}) = f_2 \times 300.31$

Cerium (Ce)
 $Z = 58$
 Atomic Weight = 140.115

Line	E(eV)	$\mu(\text{cm}^2/\text{gm})$	f_1	f_2	$\lambda(\text{\AA})$
H	10.2	3.71e+4		1.26	1215
He I	21.2	1.63e+4		1.15	584.3
Na L _{2,3}	30.5	1.34e+5		13.60	407.2
Mg L _{2,3}	49.3	2.45e+4		4.02	251.5
Al L _{2,3}	72.4	1.03e+4	4.43	2.48	171.2
Si L _{2,3}	91.5	8.56e+3	-2.54	2.61	135.5
Be K	108.5	2.25e+4	-20.31	8.14	114.3
Sr M ζ	114.0	3.58e+4	-35.37	13.60	108.8
Y M ζ	132.8	1.46e+5	44.18	64.38	93.4
Zr M ζ	151.1	3.91e+4	47.42	19.65	82.1
B K α	183.3	8.22e+3	32.35	5.02	67.6
Mo M ζ	192.6	6.21e+3	29.57	3.98	64.4
Ar L ℓ	220.1	5.27e+3	24.20	3.86	56.3
C K α	277.0	7.79e+3	20.94	7.19	44.8
Ag M ζ	311.7	7.80e+3	21.09	8.10	39.8
N K α	392.4	7.11e+3	22.29	9.29	31.6
Ti L α	452.2	6.28e+3	22.83	9.46	27.4
V L α	511.3	5.43e+3	23.16	9.25	24.2
O K α	524.9	5.26e+3	23.15	9.19	23.6
Cr L α	572.8	4.68e+3	22.98	8.92	21.6
Mn L α	637.4	4.02e+3	22.17	8.54	19.5
F K α	676.8	3.66e+3	21.44	8.24	18.3
Fe L α	705.0	3.34e+3	20.54	7.84	17.6
Co L α	776.2	2.68e+3	16.34	6.94	16.0
Ni L α	851.5	2.17e+3	2.50	6.15	14.6
Cu L α	929.7	1.42e+4	11.91	44.07	13.3
Zn L α	1011.7	1.19e+4	27.38	40.06	12.3
Na K α	1041.0	1.12e+4	30.35	38.74	11.9
Ge L α	1188.0	8.52e+3	39.39	33.72	10.4
Mg K α	1253.6	7.64e+3	42.03	31.89	9.9
Al K α	1486.7	5.32e+3	47.13	26.33	8.3
Si K α	1740.0	3.75e+3	50.64	21.73	7.1
Zr L α	2042.4	2.59e+3	52.51	17.59	6.1
Mo L α	2293.2	1.96e+3	53.27	15.00	5.4
Cl K α	2622.4	1.42e+3	53.67	12.41	4.7
Ag L α	2984.3	1.03e+3	53.72	10.28	4.2
Ca K α	3691.7	6.09e+2	53.22	7.48	3.4
Ti K α	4510.8	3.65e+2	51.97	5.48	2.7
V K α	4952.2	2.86e+2	50.82	4.71	2.5
Cr K α	5414.7	2.26e+2	48.48	4.07	2.3
Mn K α	5898.8	5.37e+2	46.79	10.55	2.1
Co K α	6930.3	5.46e+2	53.14	12.59	1.8
Ni K α	7478.2	4.52e+2	55.03	11.27	1.7
Cu K α	8047.8	3.76e+2	56.14	10.08	1.5
Ge K α	9886.4	2.21e+2	57.68	7.27	1.3
Y K α	14988.0	7.17e+1	58.05	3.58	0.8
Mo K α	17479.0	4.69e+1	57.87	2.73	0.7
Pd K α	21177.0	2.76e+1	57.58	1.94	0.6
Sn K α	25271.0	1.69e+1	57.26	1.42	0.5
Xe K α	29779.0	1.07e+1	56.92	1.06	0.4

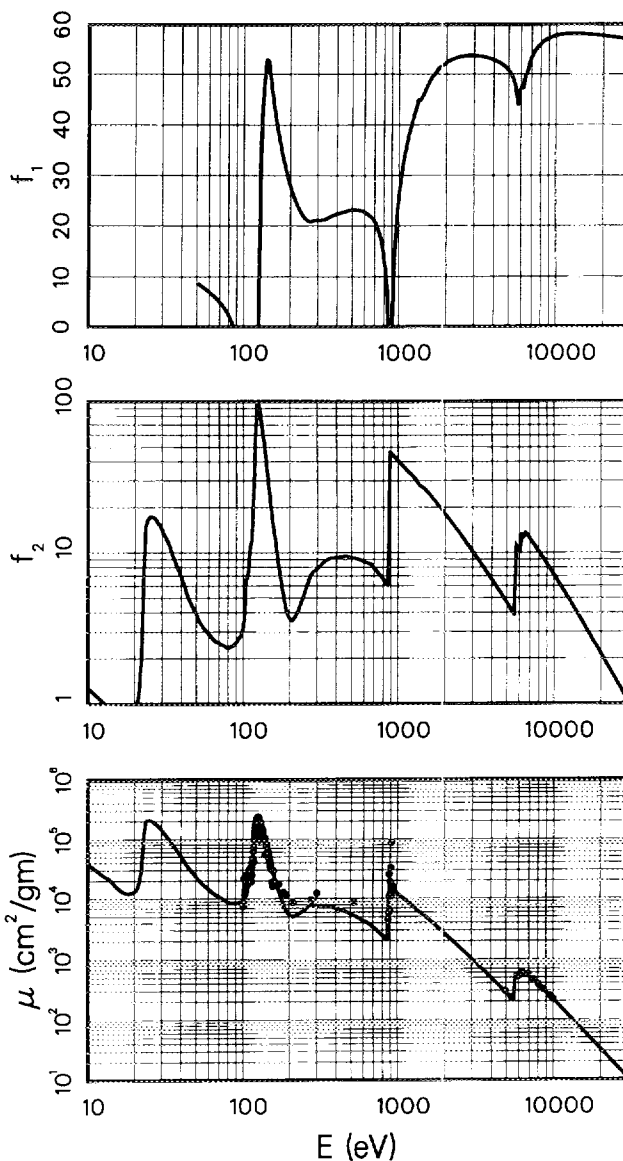

Edge Energies

L _I	6548.8 eV	M _I	1436. eV ^a	N _I	291.0 eV ^a	O _I	37.8 eV
L _{II}	6164.2 eV	M _{II}	1274. eV ^a	N _{II}	223.3 eV	O _{II}	19.8 eV ^a
L _{III}	5723.4 eV	M _{III}	1187. eV ^a	N _{III}	206.5 eV ^a	O _{III}	17.0 eV ^a
		M _{IV}	902.4 eV ^a	N _{IV}	109.0 eV ^a		
		M _V	883.8 eV ^a				

References: 116, 148, 152, 157.

TABLE I. Photoabsorption Cross Sections and Atomic Scattering Factors,
 $Z = 1-92$, $E = 50-30,000$ eV
 See page 211 for Explanation of Tables

$\mu_a(\text{barns/atom}) = \mu(\text{cm}^2/\text{gm}) \times 233.99$
 $E(\text{keV})\mu(\text{cm}^2/\text{gm}) = f_2 \times 298.62$

Praseodymium (Pr)
 $Z = 59$
 Atomic Weight = 140.908

Line	E(eV)	$\mu(\text{cm}^2/\text{gm})$	f_1	f_2	$\lambda(\text{\AA})$
H	10.2	3.67e + 4		1.25	1215
He I	21.2	2.27e + 4		1.61	584.3
Na L _{2,3}	30.5	1.39e + 5		14.21	407.2
Mg L _{2,3}	49.3	3.03e + 4		5.00	251.5
Al L _{2,3}	72.4	1.37e + 4	11.40	3.32	171.2
Si L _{2,3}	91.5	1.02e + 4	7.25	3.14	135.5
Be K	108.5	1.21e + 4	-5.33	4.38	114.3
Sr M ζ	114.0	2.11e + 4	-11.42	8.04	108.8
Y M ζ	132.8	1.11e + 5	33.07	49.36	93.4
Zr M ζ	151.1	4.69e + 4	40.00	23.72	82.1
B K α	183.3	1.17e + 4	34.03	7.21	67.6
Mo M ζ	192.6	9.23e + 3	31.91	5.95	64.4
Ar L ℓ	220.1	6.67e + 3	27.27	4.91	56.3
C K α	277.0	7.26e + 3	24.32	6.73	44.8
Ag M ζ	311.7	7.85e + 3	23.98	8.19	39.8
N K α	392.4	7.47e + 3	25.75	9.81	31.6
Ti L α	452.2	6.56e + 3	26.93	9.94	27.4
V L α	511.3	5.68e + 3	27.56	9.72	24.2
O K α	524.9	5.50e + 3	27.67	9.67	23.6
Cr L α	572.8	4.92e + 3	28.09	9.43	21.6
Mn L α	637.4	4.04e + 3	27.97	8.62	19.5
F K α	676.8	3.63e + 3	27.53	8.24	18.3
Fe L α	705.0	3.38e + 3	27.08	7.99	17.6
Co L α	776.2	2.76e + 3	25.15	7.17	16.0
Ni L α	851.5	2.25e + 3	20.30	6.42	14.6
Cu L α	929.7	8.03e + 3	1.98	24.98	13.3
Zn L α	1011.7	9.65e + 3	24.45	32.69	12.3
Na K α	1041.0	9.26e + 3	27.88	32.27	11.9
Ge L α	1188.0	6.91e + 3	37.21	27.49	10.4
Mg K α	1253.6	6.15e + 3	38.26	25.81	9.9
Al K α	1486.7	5.29e + 3	43.10	26.35	8.3
Si K α	1740.0	3.88e + 3	49.73	22.61	7.1
Zr L α	2042.4	2.66e + 3	52.54	18.16	6.1
Mo L α	2293.2	2.01e + 3	53.62	15.42	5.4
Cl K α	2622.4	1.45e + 3	54.26	12.71	4.7
Ag L α	2984.3	1.05e + 3	54.44	10.52	4.2
Ca K α	3691.7	6.21e + 2	54.12	7.67	3.4
Ti K α	4510.8	3.76e + 2	53.13	5.68	2.7
V K α	4952.2	2.98e + 2	52.26	4.94	2.5
Cr K α	5414.7	2.38e + 2	50.79	4.32	2.3
Mn K α	5898.8	2.04e + 2	45.65	4.03	2.1
Co K α	6930.3	5.66e + 2	52.11	13.13	1.8
Ni K α	7478.2	4.70e + 2	55.05	11.78	1.7
Cu K α	8047.8	3.92e + 2	56.48	10.56	1.5
Ge K α	9886.4	2.31e + 2	58.40	7.66	1.3
Y K α	14988.0	7.57e + 1	59.02	3.80	0.8
Mo K α	17479.0	4.96e + 1	58.87	2.90	0.7
Pd K α	21177.0	2.91e + 1	58.60	2.07	0.6
Sn K α	25271.0	1.78e + 1	58.30	1.51	0.5
Xe K α	29779.0	1.13e + 1	57.98	1.13	0.4

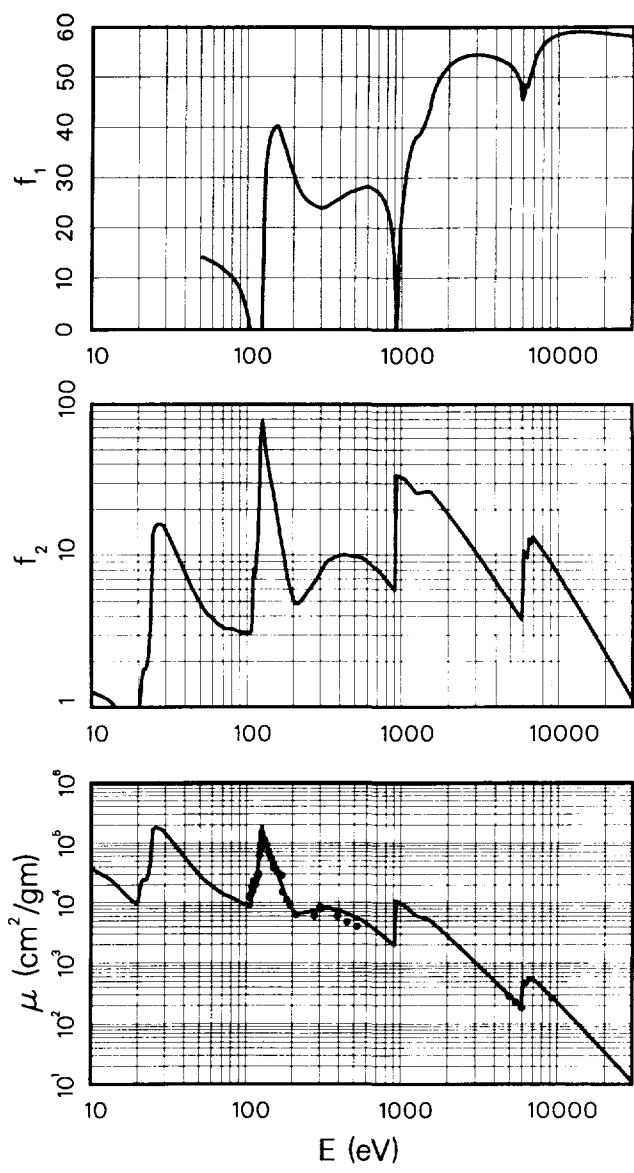

Edge Energies

L _I	6834.8 eV	M _I	1511.0 eV	N _I	304.5 eV	O _I	37.4 eV
L _{II}	6440.4 eV	M _{II}	1337.4 eV	N _{II}	236.3 eV	O _{II}	22.3 eV
L _{III}	5964.3 eV	M _{III}	1242.2 eV	N _{III}	217.6 eV	O _{III}	22.3 eV
		M _{IV}	948.3 eV ^a	N _{IV}	115.1 eV ^a		
		M _V	928.8 eV ^a	N _V	115.1 eV ^a		

References: 116, 130, 148.

TABLE I. Photoabsorption Cross Sections and Atomic Scattering Factors,
 $Z = 1-92$, $E = 50-30,000$ eV
 See page 211 for Explanation of Tables

μ_a (barns/atom) = μ (cm²/gm) \times 239.52
 E (keV) μ (cm²/gm) = $f_2 \times 291.72$

Neodymium (Nd)
 $Z = 60$
 Atomic Weight = 144.240

Line	E(eV)	μ (cm ² /gm)	f_1	f_2	λ (Å)
H	10.2	7.25e+3		0.25	1215
He I	21.2	2.77e+4		2.02	584.3
Na L _{2,3}	30.5	1.09e+5		11.42	407.2
Mg L _{2,3}	49.3	4.02e+4		6.80	251.5
Al L _{2,3}	72.4	2.43e+4	12.71	6.04	171.2
Si L _{2,3}	91.5	1.73e+4	11.04	5.44	135.5
Be K	108.5	1.35e+4	4.87	5.02	114.3
Sr M ζ	114.0	1.82e+4	0.18	7.11	108.8
Y M ζ	132.8	1.03e+5	10.10	46.88	93.4
Zr M ζ	151.1	5.05e+4	34.36	26.16	82.1
B K α	183.3	1.70e+4	31.97	10.70	67.6
Mo M ζ	192.6	1.44e+4	30.52	9.49	64.4
Ar L l	220.1	1.08e+4	27.69	8.16	56.3
C K α	277.0	8.72e+3	25.89	8.28	44.8
Ag M ζ	311.7	8.40e+3	25.62	8.98	39.8
N K α	392.4	7.48e+3	26.97	10.06	31.6
Ti L α	452.2	6.64e+3	27.63	10.29	27.4
V L α	511.3	5.87e+3	28.42	10.29	24.2
O K α	524.9	5.71e+3	28.55	10.27	23.6
Cr L α	572.8	5.17e+3	28.96	10.15	21.6
Mn L α	637.4	4.51e+3	29.36	9.85	19.5
F K α	676.8	4.08e+3	29.35	9.46	18.3
Fe L α	705.0	3.81e+3	29.21	9.20	17.6
Co L α	776.2	3.17e+3	28.25	8.44	16.0
Ni L α	851.5	2.68e+3	25.85	7.82	14.6
Cu L α	929.7	2.29e+3	19.91	7.31	13.3
Zn L α	1011.7	8.68e+3	17.97	30.10	12.3
Na K α	1041.0	8.28e+3	23.49	29.55	11.9
Ge L α	1188.0	6.64e+3	33.72	27.06	10.4
Mg K α	1253.6	6.11e+3	35.39	26.25	9.9
Al K α	1486.7	5.41e+3	42.08	27.58	8.3
Si K α	1740.0	4.06e+3	49.35	24.21	7.1
Zr L α	2042.4	2.78e+3	52.81	19.47	6.1
Mo L α	2293.2	2.11e+3	54.16	16.55	5.4
Cl K α	2622.4	1.52e+3	54.99	13.68	4.7
Ag L α	2984.3	1.11e+3	55.32	11.35	4.2
Ca K α	3691.7	6.56e+2	55.18	8.31	3.4
Ti K α	4510.8	3.98e+2	54.38	6.16	2.7
V K α	4952.2	3.15e+2	53.67	5.35	2.5
Cr K α	5414.7	2.51e+2	52.57	4.67	2.3
Mn K α	5898.8	2.02e+2	50.27	4.09	2.1
Co K α	6930.3	5.24e+2	51.50	12.46	1.8
Ni K α	7478.2	4.93e+2	54.80	12.64	1.7
Cu K α	8047.8	4.11e+2	56.77	11.35	1.5
Ge K α	9886.4	2.43e+2	59.19	8.24	1.3
Y K α	14988.0	7.97e+1	60.05	4.09	0.8
Mo K α	17479.0	5.22e+1	59.92	3.13	0.7
Pd K α	21177.0	3.07e+1	59.66	2.23	0.6
Sn K α	25271.0	1.88e+1	59.37	1.63	0.5
Xe K α	29779.0	1.19e+1	59.07	1.22	0.4

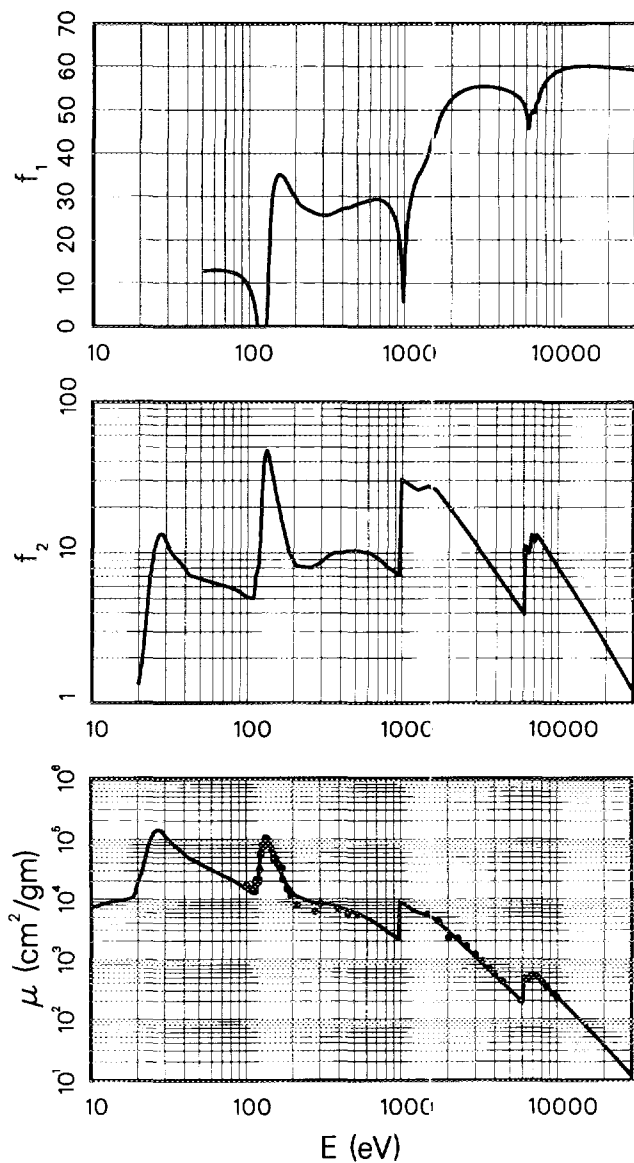

Edge Energies

L _I	7126.0 eV	M _I	1575.3 eV	N _I	319.2 eV ^a	O _I	37.5 eV
L _{II}	6721.5 eV	M _{II}	1402.8 eV	N _{II}	243.3 eV	O _{II}	21.1 eV
L _{III}	6207.9 eV	M _{III}	1297.4 eV	N _{III}	224.6 eV	O _{III}	21.1 eV
		M _{IV}	1003.3 eV ^a	N _{IV}	120.5 eV ^a		
		M _V	980.4 eV ^a	N _V	120.5 eV ^a		

References: 116, 152.

TABLE I. Photoabsorption Cross Sections and Atomic Scattering Factors.

Z = 1-92, E = 50-30,000 eV

See page 211 for Explanation of Tables

Promethium (Pm)

Z = 61

Atomic Weight = 146.920

$$\mu_a(\text{barns/atom}) = \mu(\text{cm}^2/\text{gm}) \times 243.97$$

$$E(\text{keV})\mu(\text{cm}^2/\text{gm}) = f_2 \times 286.40$$

Line	E(eV)	$\mu(\text{cm}^2/\text{gm})$	f_1	f_2	$\lambda(\text{\AA})$
H	10.2	6.27e + 3		0.22	1215
He I	21.2	4.17e + 4		3.09	584.3
Na L _{2,3}	30.5	1.23e + 5		13.08	407.2
Mg L _{2,3}	49.3	3.82e + 4		6.57	251.5
Al L _{2,3}	72.4	2.26e + 4	11.95	5.72	171.2
Si L _{2,3}	91.5	1.69e + 4	10.11	5.40	135.5
Be K	108.5	1.27e + 4	5.20	4.79	114.3
Sr M ζ	114.0	1.13e + 4	1.20	4.49	108.8
Y M ζ	132.8	1.14e + 5		52.65	93.4
Zr M ζ	151.1	5.70e + 4	31.10	30.08	82.1
B K α	183.3	2.33e + 4	32.44	14.88	67.6
Mo M ζ	192.6	1.95e + 4	31.79	13.13	64.4
Ar L l	220.1	1.32e + 4	29.54	10.17	56.3
C K α	277.0	9.70e + 3	27.02	9.38	44.8
Ag M ζ	311.7	9.34e + 3	26.71	10.17	39.8
N K α	392.4	8.37e + 3	28.42	11.47	31.6
Ti L α	452.2	6.99e + 3	29.46	11.03	27.4
V L α	511.3	6.08e + 3	30.21	10.86	24.2
O K α	524.9	5.88e + 3	30.38	10.77	23.6
Cr L α	572.8	5.19e + 3	30.80	10.39	21.6
Mn L α	637.4	4.44e + 3	31.00	9.87	19.5
F K α	676.8	4.03e + 3	30.92	9.52	18.3
Fe L α	705.0	3.79e + 3	30.78	9.33	17.6
Co L α	776.2	3.24e + 3	30.12	8.78	16.0
Ni L α	851.5	2.76e + 3	28.58	8.20	14.6
Cu L α	929.7	2.36e + 3	25.33	7.66	13.3
Zn L α	1011.7	2.02e + 3	11.91	7.14	12.3
Na K α	1041.0	7.81e + 3	12.47	28.39	11.9
Ge L α	1188.0	6.92e + 3	30.69	28.71	10.4
Mg K α	1253.6	6.59e + 3	33.81	28.84	9.9
Al K α	1486.7	5.58e + 3	43.12	28.96	8.3
Si K α	1740.0	4.12e + 3	50.01	25.01	7.1
Zr L α	2042.4	2.84e + 3	53.71	20.22	6.1
Mo L α	2293.2	2.15e + 3	55.20	17.23	5.4
Cl K α	2622.4	1.56e + 3	56.15	14.24	4.7
Ag L α	2984.3	1.13e + 3	56.56	11.81	4.2
Ca K α	3691.7	6.70e + 2	56.52	8.64	3.4
Ti K α	4510.8	4.06e + 2	55.83	6.40	2.7
V K α	4952.2	3.21e + 2	55.24	5.55	2.5
Cr K α	5414.7	2.56e + 2	54.38	4.84	2.3
Mn K α	5898.8	2.06e + 2	52.90	4.25	2.1
Co K α	6930.3	4.03e + 2	50.48	9.75	1.8
Ni K α	7478.2	5.04e + 2	53.59	13.16	1.7
Cu K α	8047.8	4.19e + 2	57.16	11.78	1.5
Ge K α	9886.4	2.45e + 2	60.07	8.44	1.3
Y K α	14988.0	7.93e + 1	60.96	4.15	0.8
Mo K α	17479.0	5.23e + 1	60.85	3.19	0.7
Pd K α	21177.0	3.11e + 1	60.62	2.30	0.6
Sn K α	25271.0	1.92e + 1	60.35	1.69	0.5
Xe K α	29779.0	1.22e + 1	60.07	1.27	0.4

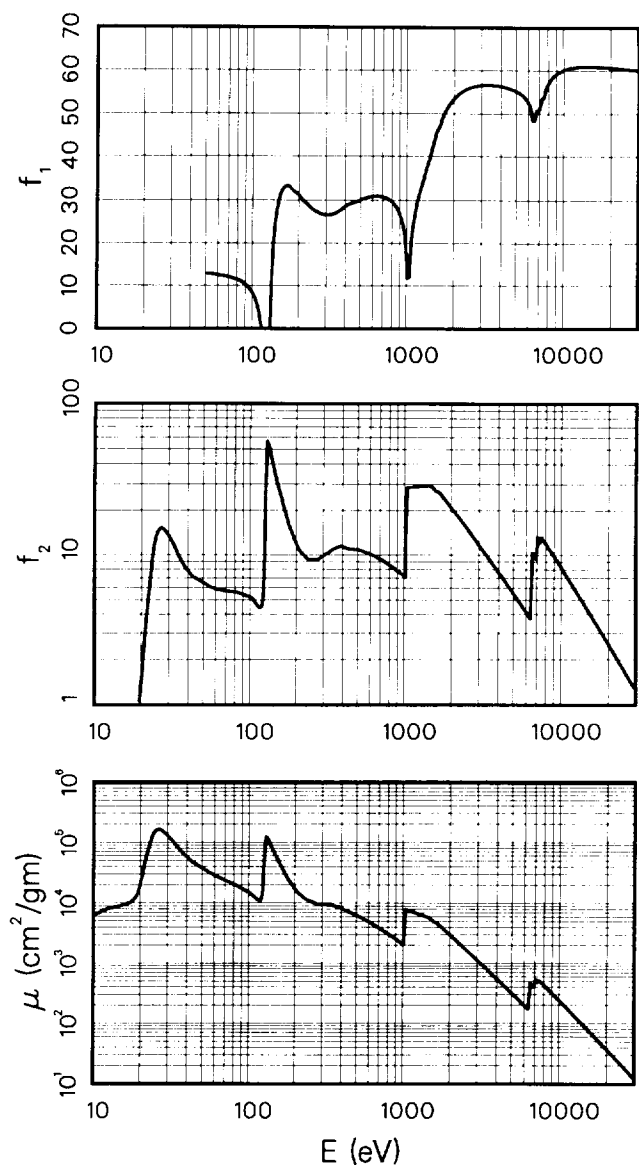

Edge Energies

L _I	7427.9 eV	M _{II}	1471.4 eV	N _{II}	242. eV
L _{II}	7012.8 eV	M _{III}	1356.9 eV	N _{III}	242. eV
L _{III}	6459.3 eV	M _{IV}	1051.5 eV	N _{IV}	120. eV
		M _V	1026.9 eV	N _V	120. eV

TABLE I. Photoabsorption Cross Sections and Atomic Scattering Factors,
 $Z = 1-92$, $E = 50-30,000$ eV
 See page 211 for Explanation of Tables

μ_a (barns/atom) = μ (cm²/gm) \times 249.68
 E (keV) μ (cm²/gm) = $f_2 \times 279.85$

Samarium (Sm)
 $Z = 62$
 Atomic Weight = 150.360

Line	E(eV)	μ (cm ² /gm)	f_1	f_2	λ (Å)
H	10.2	5.41e + 3		0.20	1215
He I	21.2	2.12e + 4		1.61	584.3
Na L _{2,3}	30.5	1.07e + 5		11.66	407.2
Mg L _{2,3}	49.3	4.48e + 4		7.89	251.5
Al L _{2,3}	72.4	2.94e + 4	10.56	7.60	171.2
Si L _{2,3}	91.5	2.11e + 4	9.97	6.90	135.5
Be K	108.5	1.42e + 4	7.61	5.49	114.3
Sr M ζ	114.0	1.08e + 4	4.98	4.39	108.8
Y M ζ	132.8	8.87e + 4	-21.92	42.09	93.4
Zr M ζ	151.1	5.69e + 4	23.82	30.74	82.1
B K α	183.3	2.70e + 4	27.61	17.68	67.6
Mo M ζ	192.6	2.34e + 4	27.46	16.08	64.4
Ar L ℓ	220.1	1.67e + 4	26.58	13.13	56.3
C K α	277.0	1.22e + 4	25.65	12.08	44.8
Ag M ζ	311.7	1.10e + 4	25.58	12.22	39.8
N K α	392.4	9.38e + 3	27.59	13.16	31.6
Ti L α	452.2	7.71e + 3	29.00	12.45	27.4
V L α	511.3	6.52e + 3	29.74	11.92	24.2
O K α	524.9	6.30e + 3	29.89	11.81	23.6
Cr L α	572.8	5.55e + 3	30.32	11.36	21.6
Mn L α	637.4	4.72e + 3	30.58	10.76	19.5
F K α	676.8	4.29e + 3	30.55	10.37	18.3
Fe L α	705.0	4.03e + 3	30.46	10.15	17.6
Co L α	776.2	3.44e + 3	29.98	9.55	16.0
Ni L α	851.5	2.93e + 3	28.82	8.92	14.6
Cu L α	929.7	2.51e + 3	26.56	8.33	13.3
Zn L α	1011.7	2.14e + 3	21.48	7.75	12.3
Na K α	1041.0	2.03e + 3	17.49	7.56	11.9
Ge L α	1188.0	7.43e + 3	25.88	31.54	10.4
Mg K α	1253.6	7.03e + 3	30.41	31.49	9.9
Al K α	1486.7	5.84e + 3	40.74	31.02	8.3
Si K α	1740.0	4.57e + 3	48.50	28.40	7.1
Zr L α	2042.4	3.16e + 3	53.78	23.06	6.1
Mo L α	2293.2	2.40e + 3	55.71	19.67	5.4
Cl K α	2622.4	1.74e + 3	56.98	16.27	4.7
Ag L α	2984.3	1.27e + 3	57.57	13.50	4.2
Ca K α	3691.7	7.48e + 2	57.69	9.87	3.4
Ti K α	4510.8	4.53e + 2	57.10	7.31	2.7
V K α	4952.2	3.58e + 2	56.58	6.34	2.5
Cr K α	5414.7	2.86e + 2	55.83	5.53	2.3
Mn K α	5898.8	2.30e + 2	54.69	4.85	2.1
Co K α	6930.3	4.37e + 2	51.23	10.82	1.8
Ni K α	7478.2	4.77e + 2	53.35	12.74	1.7
Cu K α	8047.8	4.58e + 2	56.73	13.16	1.5
Ge K α	9886.4	2.69e + 2	61.40	9.49	1.3
Y K α	14988.0	8.41e + 1	62.09	4.50	0.8
Mo K α	17479.0	5.52e + 1	61.98	3.45	0.7
Pd K α	21177.0	3.25e + 1	61.73	2.46	0.6
Sn K α	25271.0	1.99e + 1	61.44	1.80	0.5
Xe K α	29779.0	1.26e + 1	61.15	1.35	0.4

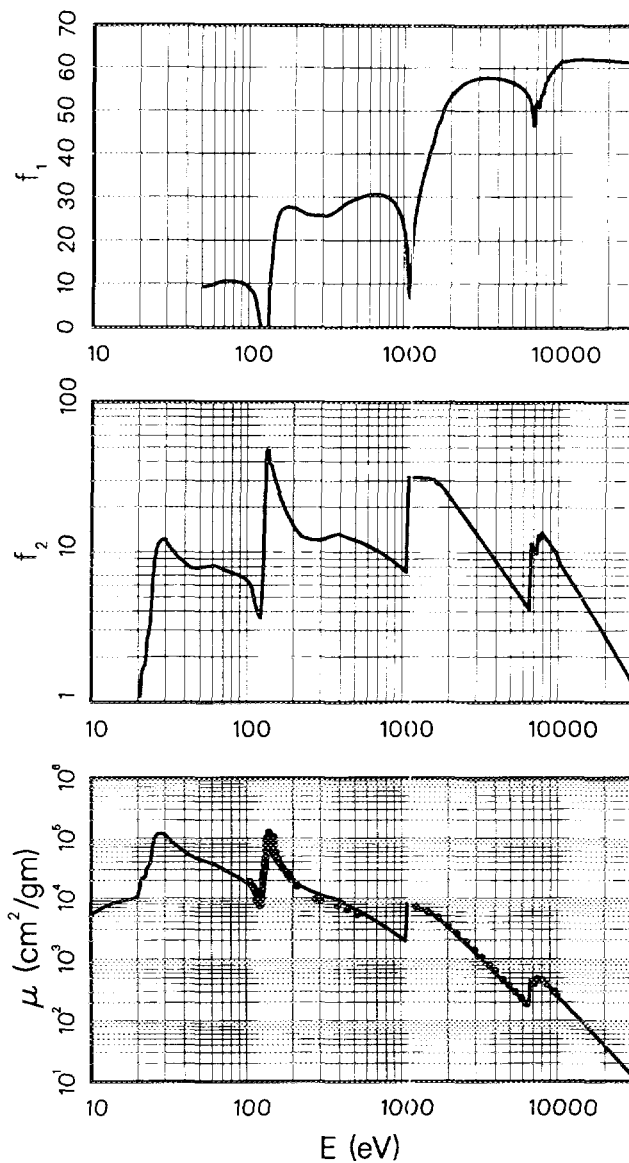

Edge Energies

L _I	7736.8 eV	M _I	1722.8 eV	N _I	347.2 eV ^a	O _I	37.4 eV
L _{II}	7311.8 eV	M _{II}	1540.7 eV	N _{II}	265.6 eV	O _{II}	21.3 eV
L _{III}	6716.2 eV	M _{III}	1419.8 eV	N _{III}	247.4 eV	O _{III}	21.3 eV
		M _{IV}	1110.9 eV ^a	N _{IV}	129. eV		
		M _V	1083.4 eV ^a	N _V	129. eV		

References: 116, 148, 152.

TABLE I. Photoabsorption Cross Sections and Atomic Scattering Factors.

 $Z = 1-92, E = 50-30,000 \text{ eV}$

See page 211 for Explanation of Tables

$$\mu_a(\text{barns/atom}) = \mu(\text{cm}^2/\text{gm}) \times 252.35$$

$$E(\text{keV})\mu(\text{cm}^2/\text{gm}) = f_2 \times 276.89$$

Europium (Eu)

 $Z = 63$

Atomic Weight = 151.965

Line	E(eV)	$\mu(\text{cm}^2/\text{gm})$	f_1	f_2	$\lambda(\text{\AA})$
H	10.2	5.35e+3		0.20	1215
He I	21.2	1.73e+4		1.33	584.3
Na L _{2,3}	30.5	1.48e+5		16.28	407.2
Mg L _{2,3}	49.3	4.70e+4		8.36	251.5
Al L _{2,3}	72.4	2.86e+4	11.25	7.49	171.2
Si L _{2,3}	91.5	2.22e+4	11.25	7.35	135.5
Be K	108.5	1.61e+4	9.96	6.33	114.3
Sr M ζ	114.0	1.34e+4	8.69	5.53	108.8
Y M ζ	132.8	1.31e+4	-19.41	6.30	93.4
Zr M ζ	151.1	4.71e+4	23.31	25.71	82.1
B K α	183.3	2.75e+4	24.95	18.23	67.6
Mo M ζ	192.6	2.44e+4	25.51	16.98	64.4
Ar L l	220.1	1.76e+4	25.76	13.96	56.3
C K α	277.0	1.24e+4	25.28	12.37	44.8
Ag M ζ	311.7	1.10e+4	25.33	12.36	39.8
N K α	392.4	9.54e+3	26.96	13.52	31.6
Ti L α	452.2	8.05e+3	28.54	13.15	27.4
V L α	511.3	6.86e+3	29.52	12.66	24.2
O K α	524.9	6.62e+3	29.71	12.55	23.6
Cr L α	572.8	5.83e+3	30.24	12.07	21.6
Mn L α	637.4	4.96e+3	30.59	11.42	19.5
F K α	676.8	4.50e+3	30.59	10.99	18.3
Fe L α	705.0	4.23e+3	30.51	10.77	17.6
Co L α	776.2	3.61e+3	30.06	10.13	16.0
Ni L α	851.5	3.08e+3	28.93	9.47	14.6
Cu L α	929.7	2.63e+3	26.77	8.83	13.3
Zn L α	1011.7	2.25e+3	22.38	8.22	12.3
Na K α	1041.0	2.13e+3	19.64	8.02	11.9
Ge L α	1188.0	1.01e+4	21.77	43.45	10.4
Mg K α	1253.6	8.90e+3	32.24	40.30	9.9
Al K α	1486.7	5.92e+3	45.35	31.81	8.3
Si K α	1740.0	4.41e+3	50.57	27.74	7.1
Zr L α	2042.4	3.15e+3	55.22	23.26	6.1
Mo L α	2293.2	2.39e+3	57.05	19.83	5.4
Cl K α	2622.4	1.73e+3	58.25	16.40	4.7
Ag L α	2984.3	1.26e+3	58.80	13.62	4.2
Ca K α	3691.7	7.48e+2	58.92	9.98	3.4
Ti K α	4510.8	4.55e+2	58.39	7.41	2.7
V K α	4952.2	3.60e+2	57.94	6.44	2.5
Cr K α	5414.7	2.87e+2	57.33	5.62	2.3
Mn K α	5898.8	2.31e+2	56.45	4.93	2.1
Co K α	6930.3	1.69e+2	48.04	4.24	1.8
Ni K α	7478.2	3.54e+2	53.26	9.57	1.7
Cu K α	8047.8	4.39e+2	55.89	12.76	1.5
Ge K α	9886.4	2.71e+2	61.46	9.66	1.3
Y K α	14988.0	8.83e+1	62.96	4.78	0.8
Mo K α	17479.0	5.81e+1	62.91	3.67	0.7
Pd K α	21177.0	3.44e+1	62.70	2.63	0.6
Sn K α	25271.0	2.11e+1	62.44	1.93	0.5
Xe K α	29779.0	1.34e+1	62.17	1.44	0.4

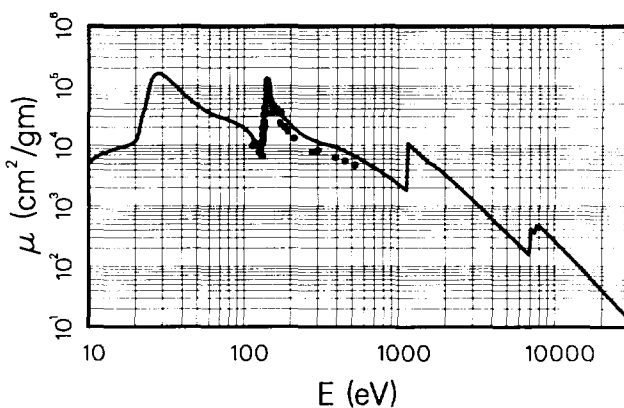
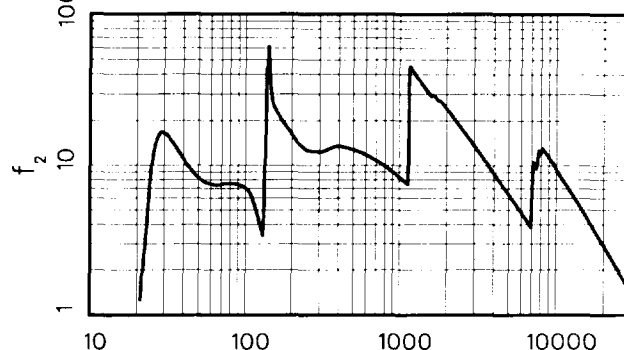
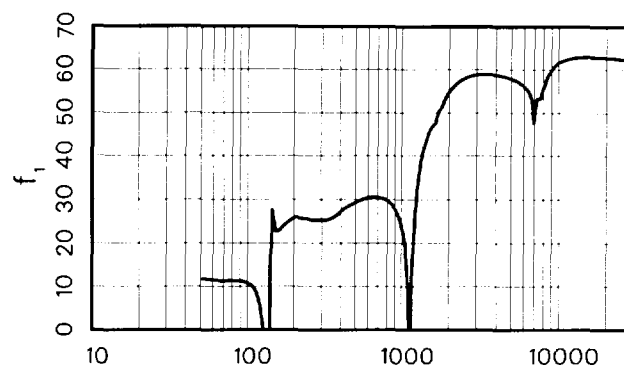

Edge Energies

L _I	8052.0 eV	M _I	1800.0 eV	N _I	360. eV	O _I	31.8 eV
L _{II}	7617.1 eV	M _{II}	1613.9 eV	N _{II}	284. eV	O _{II}	22.0 eV
L _{III}	6976.9 eV	M _{III}	1480.6 eV	N _{III}	257. eV	O _{III}	22.0 eV
		M _{IV}	1158.6 eV ^a	N _{IV}	133. eV		
		M _V	1127.5 eV ^a	N _V	127.7 eV ^a		

References: 116.

TABLE I. Photoabsorption Cross Sections and Atomic Scattering Factors,
 $Z = 1-92$, $E = 50-30,000$ eV
 See page 211 for Explanation of Tables

$\mu_a(\text{barns/atom}) = \mu(\text{cm}^2/\text{gm}) \times 261.12$
 $E(\text{keV})\mu(\text{cm}^2/\text{gm}) = f_2 \times 267.59$

Gadolinium (Gd)
 $Z = 64$
 Atomic Weight = 157.250

Line	E(eV)	$\mu(\text{cm}^2/\text{gm})$	f_1	f_2	$\lambda(\text{\AA})$
H	10.2	5.05e+4		1.92	1215
He I	21.2	2.26e+4		1.79	584.3
Na L _{2,3}	30.5	1.04e+5		11.88	407.2
Mg L _{2,3}	49.3	3.95e+4		7.27	251.5
Al L _{2,3}	72.4	2.62e+4	10.54	7.09	171.2
Si L _{2,3}	91.5	2.22e+4	10.53	7.58	135.5
Be K	108.5	1.92e+4	9.97	7.80	114.3
Sr M ζ	114.0	1.81e+4	9.61	7.70	108.8
Y M ζ	132.8	1.11e+4	2.50	5.53	93.4
Zr M ζ	151.1	9.15e+4	23.17	51.65	82.1
B K α	183.3	2.64e+4	24.01	18.11	67.6
Mo M ζ	192.6	2.36e+4	24.25	16.99	64.4
Ar L ℓ	220.1	1.84e+4	24.52	15.16	56.3
C K α	277.0	1.31e+4	25.62	13.55	44.8
Ag M ζ	311.7	1.12e+4	25.91	13.10	39.8
N K α	392.4	9.00e+3	27.31	13.19	31.6
Ti L α	452.2	7.70e+3	28.30	13.01	27.4
V L α	511.3	6.80e+3	29.39	12.99	24.2
O K α	524.9	6.57e+3	29.62	12.89	23.6
Cr L α	572.8	5.87e+3	30.32	12.56	21.6
Mn L α	637.4	5.01e+3	30.96	11.94	19.5
F K α	676.8	4.55e+3	31.12	11.51	18.3
Fe L α	705.0	4.28e+3	31.16	11.27	17.6
Co L α	776.2	3.66e+3	31.05	10.61	16.0
Ni L α	851.5	3.12e+3	30.43	9.92	14.6
Cu L α	929.7	2.67e+3	29.13	9.28	13.3
Zn L α	1011.7	2.29e+3	26.67	8.66	12.3
Na K α	1041.0	2.17e+3	25.31	8.44	11.9
Ge L α	1188.0	1.72e+3	-11.57	7.64	10.4
Mg K α	1253.6	8.41e+3	22.76	39.42	9.9
Al K α	1486.7	5.63e+3	39.43	31.27	8.3
Si K α	1740.0	4.82e+3	47.49	31.37	7.1
Zr L α	2042.4	3.45e+3	53.84	26.35	6.1
Mo L α	2293.2	2.62e+3	56.52	22.45	5.4
Cl K α	2622.4	1.90e+3	58.26	18.59	4.7
Ag L α	2984.3	1.39e+3	59.14	15.46	4.2
Ca K α	3691.7	8.23e+2	59.57	11.36	3.4
Ti K α	4510.8	5.01e+2	59.22	8.45	2.7
V K α	4952.2	3.97e+2	58.83	7.35	2.5
Cr K α	5414.7	3.17e+2	58.30	6.42	2.3
Mn K α	5898.8	2.55e+2	57.54	5.63	2.1
Co K α	6930.3	1.69e+2	53.89	4.37	1.8
Ni K α	7478.2	3.89e+2	53.06	10.88	1.7
Cu K α	8047.8	3.98e+2	54.47	11.96	1.5
Ge K α	9886.4	2.96e+2	61.65	10.93	1.3
Y K α	14988.0	9.88e+1	64.04	5.54	0.8
Mo K α	17479.0	6.52e+1	64.05	4.26	0.7
Pd K α	21177.0	3.86e+1	63.87	3.05	0.6
Sn K α	25271.0	2.37e+1	63.62	2.24	0.5
Xe K α	29779.0	1.51e+1	63.35	1.68	0.4

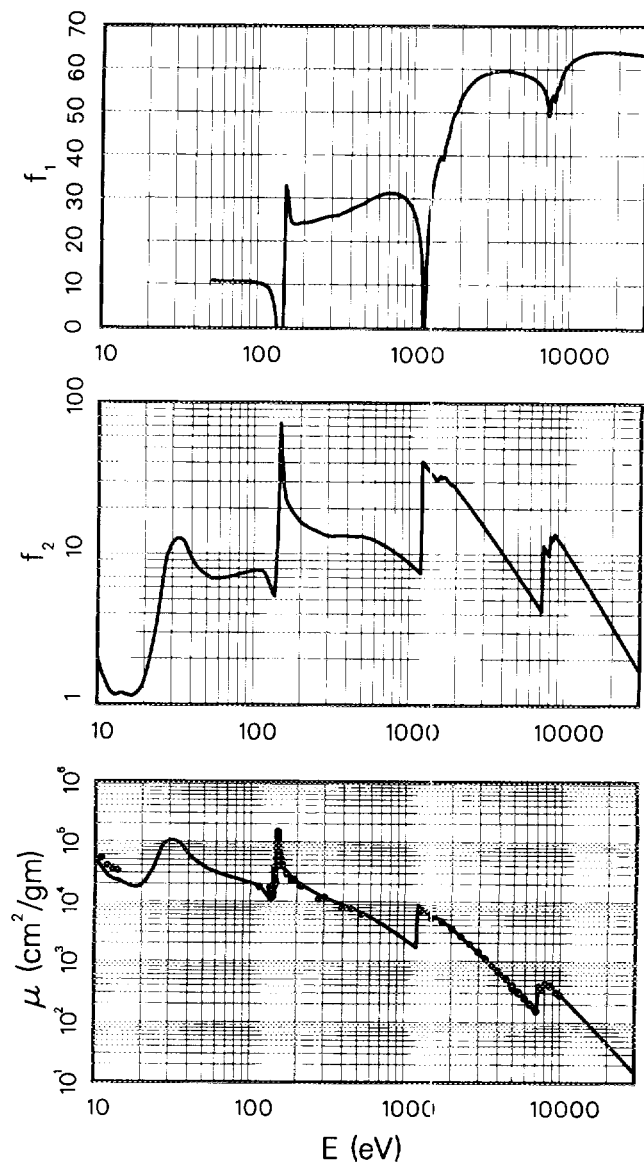

Edge Energies

L _I	8375.6 eV	M _I	1880.8 eV	N _I	373.6 eV ^a	O _I	43.5 eV ^a
L _{II}	7930.3 eV	M _{II}	1688.3 eV	N _{II}	283.5 eV	O _{II}	20. eV
L _{III}	7242.8 eV	M _{III}	1544.0 eV	N _{III}	273.9 eV	O _{III}	20. eV
		M _{IV}	1221.9 eV ^a	N _{IV}	143.5 eV		
		M _V	1189.6 eV ^a	N _V	142.6 eV ^a		

References: 116, 130, 152, 221, 222.

TABLE I. Photoabsorption Cross Sections and Atomic Scattering Factors,
 $Z = 1-92$, $E = 50-30,000$ eV
 See page 211 for Explanation of Tables

$\mu_a(\text{barns/atom}) = \mu(\text{cm}^2/\text{gm}) \times 263.91$
 $E(\text{keV})\mu(\text{cm}^2/\text{gm}) = f_2 \times 264.77$

Terbium (Tb)
 $Z = 65$
 Atomic Weight = 158.925

Line	E(eV)	$\mu(\text{cm}^2/\text{gm})$	f_1	f_2	$\lambda(\text{\AA})$
H	10.2	4.36e + 3		0.17	1215
He I	21.2	9.61e + 3		0.77	584.3
Na L _{2,3}	30.5	8.14e + 4		9.36	407.2
Mg L _{2,3}	49.3	5.09e + 4		9.48	251.5
Al L _{2,3}	72.4	3.07e + 4	12.28	8.40	171.2
Si L _{2,3}	91.5	2.51e + 4	12.29	8.67	135.5
Be K	108.5	2.19e + 4	12.62	8.98	114.3
Sr M ζ	114.0	2.03e + 4	12.43	8.74	108.8
Y M ζ	132.8	1.36e + 4	8.89	6.82	93.4
Zr M ζ	151.1	7.02e + 4	2.97	40.08	82.1
B K α	183.3	2.86e + 4	23.54	19.83	67.6
Mo M ζ	192.6	2.55e + 4	24.09	18.59	64.4
Ar L ℓ	220.1	1.97e + 4	24.99	16.40	56.3
C K α	277.0	1.48e + 4	26.08	15.48	44.8
Ag M ζ	311.7	1.32e + 4	27.18	15.60	39.8
N K α	392.4	1.05e + 4	29.59	15.49	31.6
Ti L α	452.2	8.86e + 3	31.15	15.13	27.4
V L α	511.3	7.66e + 3	32.48	14.80	24.2
O K α	524.9	7.41e + 3	32.77	14.69	23.6
Cr L α	572.8	6.60e + 3	33.68	14.28	21.6
Mn L α	637.4	5.58e + 3	34.69	13.43	19.5
F K α	676.8	5.04e + 3	35.01	12.90	18.3
Fe L α	705.0	4.71e + 3	35.15	12.54	17.6
Co L α	776.2	3.99e + 3	35.27	11.71	16.0
Ni L α	851.5	3.39e + 3	34.97	10.91	14.6
Cu L α	929.7	2.89e + 3	34.19	10.16	13.3
Zn L α	1011.7	2.47e + 3	32.64	9.45	12.3
Na K α	1041.0	2.34e + 3	31.83	9.20	11.9
Ge L α	1188.0	1.81e + 3	21.51	8.13	10.4
Mg K α	1253.6	8.24e + 3	8.29	39.02	9.9
Al K α	1486.7	5.43e + 3	41.60	30.52	8.3
Si K α	1740.0	4.45e + 3	47.62	29.23	7.1
Zr L α	2042.4	3.33e + 3	54.44	25.66	6.1
Mo L α	2293.2	2.53e + 3	57.50	21.92	5.4
Cl K α	2622.4	1.83e + 3	59.42	18.17	4.7
Ag L α	2984.3	1.34e + 3	60.40	15.09	4.2
Ca K α	3691.7	7.93e + 2	60.94	11.05	3.4
Ti K α	4510.8	4.81e + 2	60.68	8.20	2.7
V K α	4952.2	3.81e + 2	60.37	7.12	2.5
Cr K α	5414.7	3.04e + 2	59.93	6.22	2.3
Mn K α	5898.8	2.45e + 2	59.34	5.46	2.1
Co K α	6930.3	1.63e + 2	57.06	4.26	1.8
Ni K α	7478.2	1.34e + 2	51.01	3.78	1.7
Cu K α	8047.8	3.03e + 2	55.56	9.20	1.5
Ge K α	9886.4	2.82e + 2	62.05	10.55	1.3
Y K α	14988.0	9.54e + 1	64.80	5.40	0.8
Mo K α	17479.0	6.30e + 1	64.87	4.16	0.7
Pd K α	21177.0	3.74e + 1	64.74	2.99	0.6
Sn K α	25271.0	2.30e + 1	64.51	2.20	0.5
Xe K α	29779.0	1.46e + 1	64.25	1.65	0.4

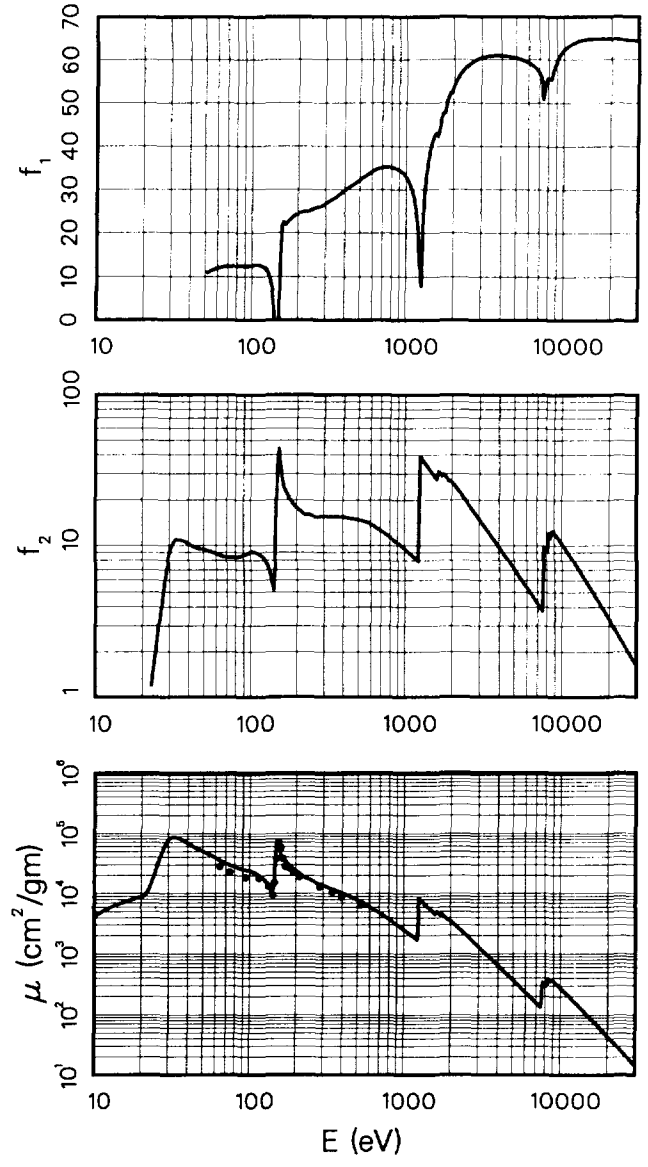

Edge Energies

L _I	8708.0 eV	M _I	1967.5 eV	N _I	396.0 eV*	O _I	45.6 eV*
L _{II}	8251.6 eV	M _{II}	1767.7 eV	N _{II}	322.4 eV*	O _{II}	28.7 eV*
L _{III}	7514.0 eV	M _{III}	1611.3 eV	N _{III}	284.1 eV*	O _{III}	22.6 eV*
		M _{IV}	1276.9 eV*	N _{IV}	150.5 eV*		
		M _V	1241.1 eV*	N _V	150.5 eV*		

References: 168.

TABLE I. Photoabsorption Cross Sections and Atomic Scattering Factors,
 $Z = 1-92$, $E = 50-30,000$ eV
 See page 211 for Explanation of Tables

Dysprosium (Dy)
 $Z = 66$
 Atomic Weight = 162.500

μ_a (barns/atom) = μ (cm²/gm) \times 269.84
 E (keV) μ (cm²/gm) = $f_2 \times 258.94$

Line	E(eV)	μ (cm ² /gm)	f_1	f_2	λ (Å)
H	10.2	4.15e+3		0.16	1215
He I	21.2	9.40e+3		0.77	584.3
Na L _{2,3}	30.5	1.10e+5		12.88	407.2
Mg L _{2,3}	49.3	5.71e+4		10.87	251.5
Al L _{2,3}	72.4	3.43e+4	10.64	9.58	171.2
Si L _{2,3}	91.5	2.94e+4	11.25	10.38	135.5
Be K	108.5	2.60e+4	11.90	10.88	114.3
Sr M ζ	114.0	2.42e+4	12.19	10.66	108.8
Y M ζ	132.8	1.81e+4	10.04	9.27	93.4
Zr M ζ	151.1	4.39e+4	-14.21	25.61	82.1
B K α	183.3	3.05e+4	22.01	21.62	67.6
Mo M ζ	192.6	2.75e+4	22.58	20.49	64.4
Ar L ℓ	220.1	2.20e+4	24.52	18.72	56.3
C K α	277.0	1.57e+4	25.74	16.81	44.8
Ag M ζ	311.7	1.41e+4	26.61	16.98	39.8
N K α	392.4	1.14e+4	29.60	17.33	31.6
Ti L α	452.2	9.66e+3	31.87	16.87	27.4
V L α	511.3	8.15e+3	33.36	16.09	24.2
O K α	524.9	7.85e+3	33.65	15.92	23.6
Cr L α	572.8	6.95e+3	34.57	15.38	21.6
Mn L α	637.4	5.87e+3	35.64	14.45	19.5
F K α	676.8	5.31e+3	36.01	13.87	18.3
Fe L α	705.0	4.96e+3	36.19	13.49	17.6
Co L α	776.2	4.22e+3	36.45	12.64	16.0
Ni L α	851.5	3.57e+3	36.38	11.74	14.6
Cu L α	929.7	3.04e+3	35.85	10.91	13.3
Zn L α	1011.7	2.59e+3	34.72	10.12	12.3
Na K α	1041.0	2.45e+3	34.13	9.85	11.9
Ge L α	1188.0	1.89e+3	27.99	8.67	10.4
Mg K α	1253.6	1.70e+3	19.01	8.23	9.9
Al K α	1486.7	5.66e+3	40.27	32.52	8.3
Si K α	1740.0	4.52e+3	47.01	30.40	7.1
Zr L α	2042.4	3.35e+3	53.74	26.39	6.1
Mo L α	2293.2	2.63e+3	57.68	23.29	5.4
Cl K α	2622.4	1.91e+3	60.02	19.35	4.7
Ag L α	2984.3	1.40e+3	61.24	16.09	4.2
Ca K α	3691.7	8.25e+2	61.99	11.77	3.4
Ti K α	4510.8	5.00e+2	61.82	8.71	2.7
V K α	4952.2	3.95e+2	61.54	7.56	2.5
Cr K α	5414.7	3.15e+2	61.15	6.59	2.3
Mn K α	5898.8	2.54e+2	60.63	5.78	2.1
Co K α	6930.3	1.69e+2	58.83	4.52	1.8
Ni K α	7478.2	1.39e+2	56.54	4.01	1.7
Cu K α	8047.8	3.19e+2	55.88	9.92	1.5
Ge K α	9886.4	2.93e+2	62.33	11.20	1.3
Y K α	14988.0	9.88e+1	65.73	5.72	0.8
Mo K α	17479.0	6.53e+1	65.85	4.41	0.7
Pd K α	21177.0	3.88e+1	65.74	3.18	0.6
Sn K α	25271.0	2.40e+1	65.53	2.34	0.5
Xe K α	29779.0	1.53e+1	65.28	1.76	0.4

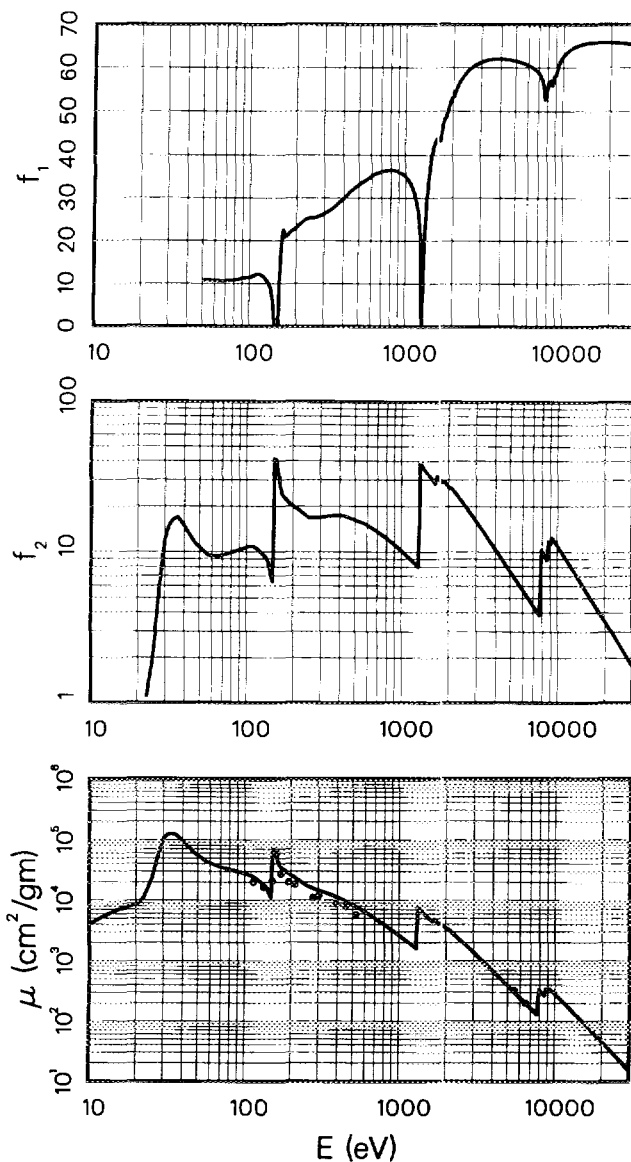

Edge Energies

L _I 9045.8 eV	M _I 2046.8 eV	N _I 414.2 eV ^a	O _I 49.9 eV ^a
L _{II} 8580.6 eV	M _{II} 1841.8 eV	N _{II} 333.5 eV ^a	O _{II} 29.5 eV ^a
L _{III} 7790.1 eV	M _{III} 1675.6 eV	N _{III} 293.2 eV ^a	O _{III} 23.1 eV ^a
	M _{IV} 1332.5 eV	N _{IV} 153.6 eV ^a	
	M _V 1292.6 eV ^a	N _V 153.6 eV ^a	

References: 116, 222.

TABLE I. Photoabsorption Cross Sections and Atomic Scattering Factors,

Z = 1-92, E = 50-30,000 eV

See page 211 for Explanation of Tables

Holmium (Ho)

Z = 67

Atomic Weight = 164.930

$$\mu_a(\text{barns/atom}) = \mu(\text{cm}^2/\text{gm}) \times 273.88$$

$$E(\text{keV})\mu(\text{cm}^2/\text{gm}) = f_2 \times 255.13$$

Line	E(eV)	$\mu(\text{cm}^2/\text{gm})$	f_1	f_2	$\lambda(\text{\AA})$
H	10.2	4.32e+3		0.17	1215
He I	21.2	8.22e+3		0.68	584.3
Na L _{2,3}	30.5	7.13e+4		8.51	407.2
Mg L _{2,3}	49.3	5.60e+4		10.82	251.5
Al L _{2,3}	72.4	3.25e+4	10.32	9.23	171.2
Si L _{2,3}	91.5	2.71e+4	10.65	9.73	135.5
Be K	108.5	2.40e+4	11.07	10.19	114.3
Sr M ζ	114.0	2.30e+4	11.19	10.26	108.8
Y M ζ	132.8	1.82e+4	10.46	9.48	93.4
Zr M ζ	151.1	1.13e+4	-3.06	6.69	82.1
B K α	183.3	2.89e+4	19.82	20.80	67.6
Mo M ζ	192.6	2.63e+4	20.45	19.83	64.4
Ar L ℓ	220.1	2.18e+4	21.78	18.77	56.3
C K α	277.0	1.59e+4	24.39	17.30	44.8
Ag M ζ	311.7	1.41e+4	25.31	17.20	39.8
N K α	392.4	1.15e+4	27.90	17.65	31.6
Ti L α	452.2	9.98e+3	30.02	17.69	27.4
V L α	511.3	8.64e+3	31.93	17.31	24.2
O K α	524.9	8.37e+3	32.33	17.22	23.6
Cr L α	572.8	7.37e+3	33.79	16.55	21.6
Mn L α	637.4	6.19e+3	34.92	15.46	19.5
F K α	676.8	5.60e+3	35.36	14.85	18.3
Fe L α	705.0	5.25e+3	35.62	14.50	17.6
Co L α	776.2	4.44e+3	36.09	13.51	16.0
Ni L α	851.5	3.76e+3	36.13	12.54	14.6
Cu L α	929.7	3.20e+3	35.78	11.66	13.3
Zn L α	1011.7	2.73e+3	34.92	10.81	12.3
Na K α	1041.0	2.58e+3	34.47	10.52	11.9
Ge L α	1188.0	1.98e+3	30.13	9.23	10.4
Mg K α	1253.6	1.78e+3	25.86	8.75	9.9
Al K α	1486.7	6.34e+3	35.34	36.95	8.3
Si K α	1740.0	4.53e+3	43.85	30.88	7.1
Zr L α	2042.4	3.65e+3	53.32	29.24	6.1
Mo L α	2293.2	2.90e+3	57.42	26.06	5.4
Cl K α	2622.4	2.11e+3	60.41	21.72	4.7
Ag L α	2984.3	1.55e+3	61.99	18.10	4.2
Ca K α	3691.7	9.16e+2	63.07	13.26	3.4
Ti K α	4510.8	5.55e+2	63.06	9.82	2.7
V K α	4952.2	4.39e+2	62.83	8.52	2.5
Cr K α	5414.7	3.50e+2	62.48	7.43	2.3
Mn K α	5898.8	2.82e+2	62.01	6.51	2.1
Co K α	6930.3	1.87e+2	60.49	5.07	1.8
Ni K α	7478.2	1.54e+2	58.95	4.50	1.7
Cu K α	8047.8	2.60e+2	54.16	8.21	1.5
Ge K α	9886.4	3.17e+2	62.96	12.29	1.3
Y K α	14988.0	1.04e+2	66.72	6.09	0.8
Mo K α	17479.0	6.86e+1	66.88	4.70	0.7
Pd K α	21177.0	4.08e+1	66.79	3.38	0.6
Sn K α	25271.0	2.51e+1	66.58	2.49	0.5
Xe K α	29779.0	1.60e+1	66.32	1.87	0.4

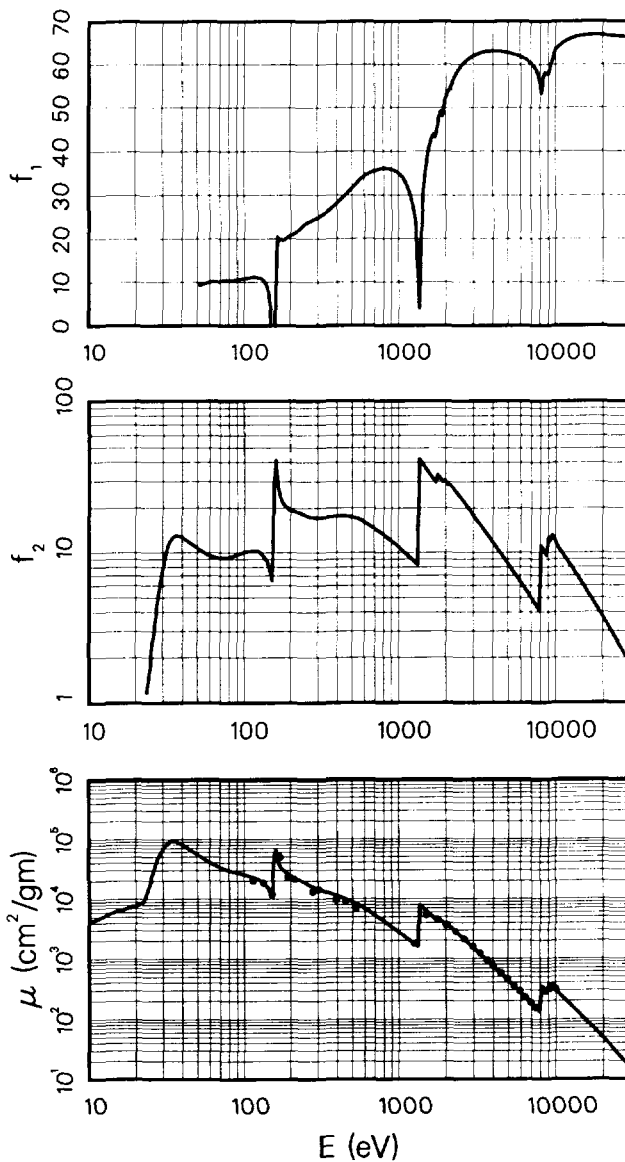

Edge Energies

L _I	9394.2 eV	M _I	2128.3 eV	N _I	432.4 eV ^a	O _I	49.3 eV ^a
L _{II}	8917.8 eV	M _{II}	1922.8 eV	N _{II}	343.5 eV	O _{II}	30.8 eV ^a
L _{III}	8071.1 eV	M _{III}	1741.2 eV	N _{III}	308.2 eV ^a	O _{III}	24.1 eV ^a
		M _{IV}	1391.5 eV	N _{IV}	160. eV ^a		
		M _V	1351.4 eV	N _V	160. eV ^a		

References: 116, 152.

TABLE I. Photoabsorption Cross Sections and Atomic Scattering Factors.
 $Z = 1-92, E = 50-30,000 \text{ eV}$
 See page 211 for Explanation of Tables

Erbium (Er)
 $Z = 68$

Atomic Weight = 167.260

$\mu_a(\text{barns/atom}) = \mu(\text{cm}^2/\text{gm}) \times 277.75$
 $E(\text{keV})\mu(\text{cm}^2/\text{gm}) = f_2 \times 251.57$

Line	E(eV)	$\mu(\text{cm}^2/\text{gm})$	f_1	f_2	$\lambda (\text{\AA})$
H	10.2	4.61e+3		0.19	1215
He I	21.2	8.16e+3		0.69	584.3
Na L _{2,3}	30.5	1.12e+5		13.60	407.2
Mg L _{2,3}	49.3	5.02e+4		9.83	251.5
Al L _{2,3}	72.4	3.29e+4	10.02	9.48	171.2
Si L _{2,3}	91.5	2.79e+4	11.00	10.14	135.5
Be K	108.5	2.51e+4	11.01	10.83	114.3
Sr M ζ	114.0	2.47e+4	11.15	11.20	108.8
Y M ζ	132.8	2.30e+4	11.59	12.16	93.4
Zr M ζ	151.1	1.66e+4	9.31	9.99	82.1
B K α	183.3	2.79e+4	17.38	20.31	67.6
Mo M ζ	192.6	2.61e+4	18.27	19.96	64.4
Ar L ℓ	220.1	2.23e+4	20.37	19.55	56.3
C K α	277.0	1.74e+4	23.64	19.11	44.8
Ag M ζ	311.7	1.59e+4	25.15	19.71	39.8
N K α	392.4	1.24e+4	29.20	19.35	31.6
Ti L α	452.2	1.07e+4	31.40	19.17	27.4
V L α	511.3	9.16e+3	33.59	18.62	24.2
O K α	524.9	8.84e+3	34.00	18.45	23.6
Cr L α	572.8	7.82e+3	35.37	17.81	21.6
Mn L α	637.4	6.61e+3	36.77	16.74	19.5
F K α	676.8	5.95e+3	37.34	16.02	18.3
Fe L α	705.0	5.58e+3	37.66	15.63	17.6
Co L α	776.2	4.72e+3	38.30	14.57	16.0
Ni L α	851.5	4.00e+3	38.56	13.53	14.6
Cu L α	929.7	3.40e+3	38.47	12.57	13.3
Zn L α	1011.7	2.90e+3	37.99	11.65	12.3
Na K α	1041.0	2.74e+3	37.70	11.33	11.9
Ge L α	1188.0	2.10e+3	34.83	9.91	10.4
Mg K α	1253.6	1.88e+3	32.34	9.38	9.9
Al K α	1486.7	6.36e+3	30.86	37.59	8.3
Si K α	1740.0	4.34e+3	45.56	30.01	7.1
Zr L α	2042.4	3.66e+3	52.55	29.71	6.1
Mo L α	2293.2	2.90e+3	57.41	26.41	5.4
Cl K α	2622.4	2.11e+3	60.89	22.01	4.7
Ag L α	2984.3	1.55e+3	62.65	18.35	4.2
Ca K α	3691.7	9.19e+2	63.90	13.49	3.4
Ti K α	4510.8	5.59e+2	64.03	10.03	2.7
V K α	4952.2	4.43e+2	63.85	8.71	2.5
Cr K α	5414.7	3.54e+2	63.57	7.61	2.3
Mn K α	5898.8	2.85e+2	63.18	6.67	2.1
Co K α	6930.3	1.89e+2	61.95	5.20	1.8
Ni K α	7478.2	1.55e+2	60.85	4.61	1.7
Cu K α	8047.8	1.28e+2	58.42	4.10	1.5
Ge K α	9886.4	3.18e+2	61.67	12.48	1.3
Y K α	14988.0	1.09e+2	67.52	6.47	0.8
Mo K α	17479.0	7.21e+1	67.79	5.01	0.7
Pd K α	21177.0	4.29e+1	67.77	3.61	0.6
Sn K α	25271.0	2.64e+1	67.59	2.65	0.5
Xe K α	29779.0	1.68e+1	67.35	1.99	0.4

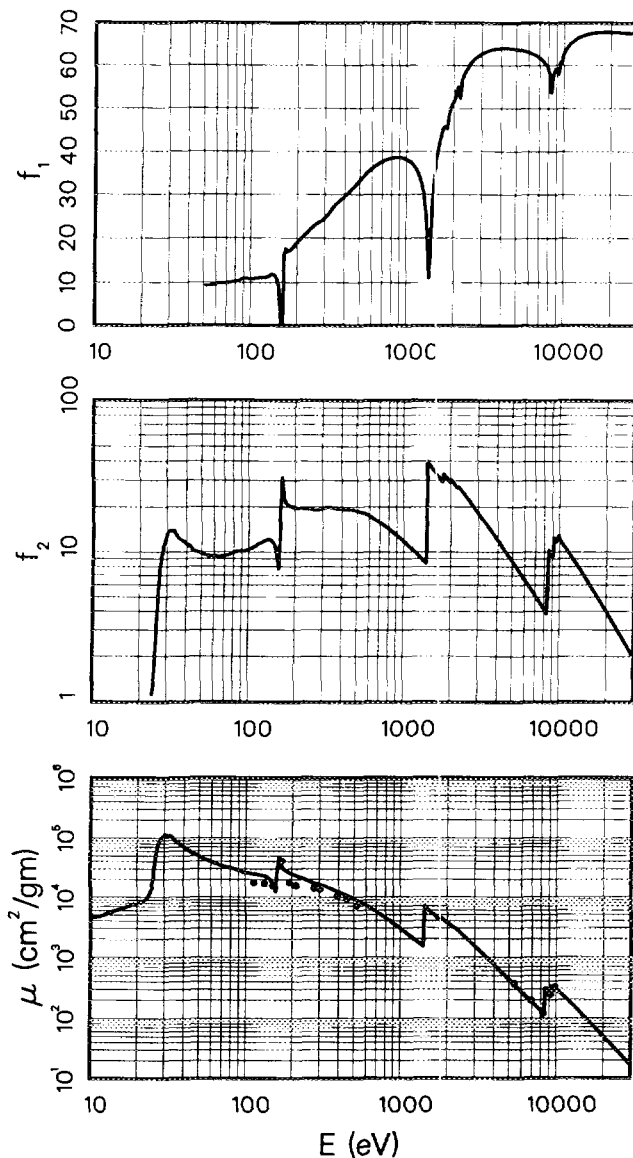

Edge Energies

L _I	9751.3 eV	M _I	2206.5 eV	N _I	449.8 eV ^a	O _I	50.6 eV ^a
L _{II}	9264.3 eV	M _{II}	2005.8 eV	N _{II}	366.2 eV	O _{II}	31.4 eV ^a
L _{III}	8357.9 eV	M _{III}	1811.8 eV	N _{III}	320.2 eV ^a	O _{III}	24.7 eV ^a
		M _{IV}	1453.3 eV	N _{IV}	167.6 eV ^a		
		M _V	1409.3 eV	N _V	167.6 eV ^a		

References: 116, 130.

TABLE I. Photoabsorption Cross Sections and Atomic Scattering Factors,

$Z = 1-92, E = 50-30,000 \text{ eV}$

See page 211 for Explanation of Tables

Thulium (Tm)

Z = 69

Atomic Weight = 168.934

$$\mu_a(\text{barns/atom}) = \mu(\text{cm}^2/\text{gm}) \times 280.53$$

$$E(\text{keV})\mu(\text{cm}^2/\text{gm}) = f_2 \times 249.08$$

Line	E(eV)	$\mu(\text{cm}^2/\text{gm})$	f_1	f_2	$\lambda(\text{\AA})$
H	10.2	4.51e+3		0.18	1215
He I	21.2	7.79e+3		0.66	584.3
Na L _{2,3}	30.5	6.90e+4		8.43	407.2
Mg L _{2,3}	49.3	4.99e+4		9.88	251.5
Al L _{2,3}	72.4	3.21e+4	9.74	9.32	171.2
Si L _{2,3}	91.5	2.82e+4	10.27	10.37	135.5
Be K	108.5	2.61e+4	11.06	11.35	114.3
Sr M ζ	114.0	2.60e+4	11.21	11.89	108.8
Y M ζ	132.8	2.39e+4	12.48	12.76	93.4
Zr M ζ	151.1	2.11e+4	13.44	12.80	82.1
B K α	183.3	3.00e+4	18.49	22.06	67.6
Mo M ζ	192.6	2.43e+4	18.31	18.78	64.4
Ar L l	220.1	2.08e+4	18.97	18.38	56.3
C K α	277.0	1.71e+4	22.70	19.01	44.8
Ag M ζ	311.7	1.50e+4	24.38	18.83	39.8
N K α	392.4	1.25e+4	27.08	19.70	31.6
Ti L α	452.2	1.12e+4	29.78	20.28	27.4
V L α	511.3	9.85e+3	32.46	20.21	24.2
O K α	524.9	9.53e+3	33.09	20.09	23.6
Cr L α	572.8	8.38e+3	34.90	19.26	21.6
Mn L α	637.4	7.08e+3	36.57	18.11	19.5
F K α	676.8	6.39e+3	37.29	17.36	18.3
Fe L α	705.0	5.99e+3	37.72	16.94	17.6
Co L α	776.2	5.06e+3	38.60	15.77	16.0
Ni L α	851.5	4.26e+3	39.05	14.58	14.6
Cu L α	929.7	3.62e+3	39.11	13.50	13.3
Zn L α	1011.7	3.08e+3	38.81	12.51	12.3
Na K α	1041.0	2.91e+3	38.62	12.15	11.9
Ge L α	1188.0	2.22e+3	36.42	10.57	10.4
Mg K α	1253.6	1.98e+3	34.60	9.99	9.9
Al K α	1486.7	7.04e+3	9.82	42.01	8.3
Si K α	1740.0	4.74e+3	45.01	33.13	7.1
Zr L α	2042.4	3.72e+3	52.21	30.46	6.1
Mo L α	2293.2	3.07e+3	56.78	28.24	5.4
Cl K α	2622.4	2.26e+3	61.41	23.78	4.7
Ag L α	2984.3	1.65e+3	63.47	19.80	4.2
Ca K α	3691.7	9.83e+2	64.97	14.57	3.4
Ti K α	4510.8	5.99e+2	65.23	10.84	2.7
V K α	4952.2	4.74e+2	65.11	9.43	2.5
Cr K α	5414.7	3.79e+2	64.87	8.24	2.3
Mn K α	5898.8	3.05e+2	64.53	7.23	2.1
Co K α	6930.3	2.02e+2	63.47	5.63	1.8
Ni K α	7478.2	1.66e+2	62.60	4.99	1.7
Cu K α	8047.8	1.37e+2	61.07	4.44	1.5
Ge K α	9886.4	2.98e+2	61.79	11.83	1.3
Y K α	14988.0	1.13e+2	68.43	6.79	0.8
Mo K α	17479.0	7.51e+1	68.76	5.27	0.7
Pd K α	21177.0	4.48e+1	68.79	3.81	0.6
Sn K α	25271.0	2.77e+1	68.63	2.81	0.5
Xe K α	29779.0	1.76e+1	68.41	2.11	0.4

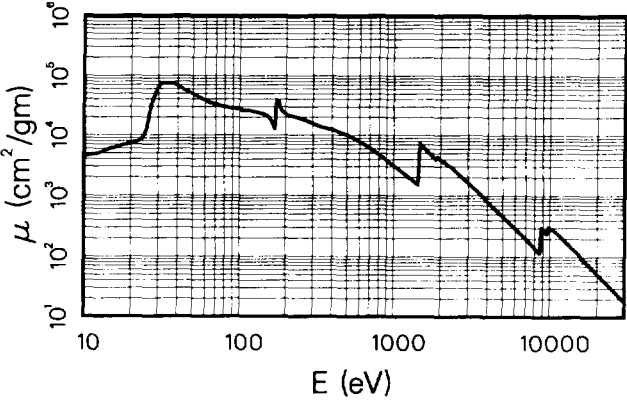
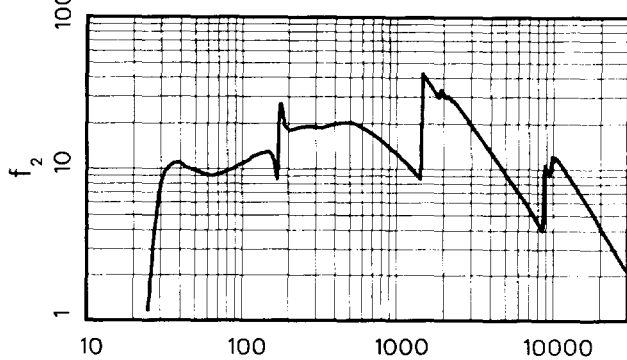
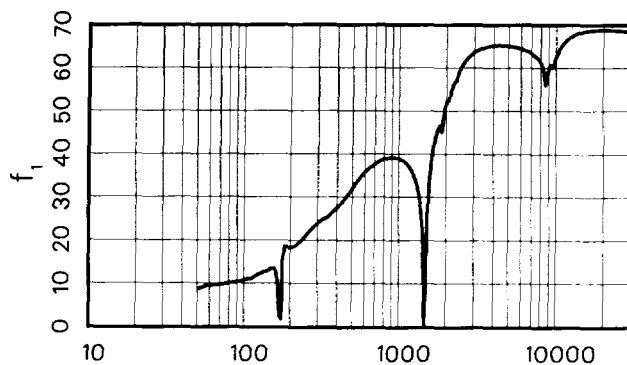

Edge Energies

L _I	10115.7 eV	M _I	2306.8 eV	N _I	470.9 eV ^a	O _I	54.7 eV ^a
L _{II}	9616.9 eV	M _{II}	2089.8 eV	N _{II}	385.9 eV	O _{II}	31.8 eV ^a
L _{III}	8648.0 eV	M _{III}	1884.5 eV	N _{III}	332.6 eV ^a	O _{III}	25.0 eV ^a
		M _{IV}	1514.6 eV	N _{IV}	175.5 eV ^a		
		M _V	1467.7 eV	N _V	175.5 eV ^a		

TABLE I. Photoabsorption Cross Sections and Atomic Scattering Factors.

 $Z = 1-92, E = 50-30,000 \text{ eV}$

See page 211 for Explanation of Tables

Ytterbium (Yb)

 $Z = 70$

Atomic Weight = 173.040

$$\mu_a(\text{barns/atom}) = \mu(\text{cm}^2/\text{gm}) \times 287.34$$

$$E(\text{keV})\mu(\text{cm}^2/\text{gm}) = f_2 \times 243.17$$

Line	E(eV)	$\mu(\text{cm}^2/\text{gm})$	f_1	f_2	$\lambda(\text{\AA})$
H	10.2	5.22e+3		0.22	1215
He I	21.2	7.50e+3		0.65	584.3
Na L _{2,3}	30.5	9.80e+4		12.28	407.2
Mg L _{2,3}	49.3	5.30e+4		10.75	251.5
Al L _{2,3}	72.4	3.63e+4	7.81	10.79	171.2
Si L _{2,3}	91.5	2.98e+4	8.46	11.23	135.5
Be K	108.5	2.86e+4	8.94	12.78	114.3
Sr M ζ	114.0	2.83e+4	9.18	13.27	108.8
Y M ζ	132.8	2.73e+4	10.18	14.92	93.4
Zr M ζ	151.1	2.65e+4	11.35	16.47	82.1
B K α	183.3	2.49e+4	13.98	18.73	67.6
Mo M ζ	192.6	2.43e+4	14.73	19.27	64.4
Ar L ℓ	220.1	2.30e+4	17.12	20.77	56.3
C K α	277.0	1.89e+4	21.81	21.51	44.8
Ag M ζ	311.7	1.71e+4	23.92	21.88	39.8
N K α	392.4	1.37e+4	28.61	22.16	31.6
Ti L α	452.2	1.18e+4	31.43	21.91	27.4
V L α	511.3	1.01e+4	33.82	21.27	24.2
O K α	524.9	9.79e+3	34.30	21.13	23.6
Cr L α	572.8	8.76e+3	36.02	20.64	21.6
Mn L α	637.4	7.41e+3	37.97	19.44	19.5
F K α	676.8	6.69e+3	38.77	18.61	18.3
Fe L α	705.0	6.27e+3	39.25	18.17	17.6
Co L α	776.2	5.31e+3	40.30	16.95	16.0
Ni L α	851.5	4.48e+3	40.95	15.67	14.6
Cu L α	929.7	3.79e+3	41.25	14.49	13.3
Zn L α	1011.7	3.21e+3	41.20	13.36	12.3
Na K α	1041.0	3.03e+3	41.10	12.98	11.9
Ge L α	1188.0	2.30e+3	39.68	11.25	10.4
Mg K α	1253.6	2.06e+3	38.50	10.61	9.9
Al K α	1486.7	1.44e+3	23.05	8.81	8.3
Si K α	1740.0	4.82e+2	41.98	34.50	7.1
Zr L α	2042.4	3.83e+2	51.28	32.20	6.1
Mo L α	2293.2	3.06e+2	56.80	28.89	5.4
Cl K α	2622.4	2.32e+2	61.33	24.97	4.7
Ag L α	2984.3	1.70e+2	63.86	20.84	4.2
Ca K α	3691.7	1.01e+2	65.75	15.36	3.4
Ti K α	4510.8	6.17e+1	66.19	11.44	2.7
V K α	4952.2	4.89e+1	66.13	9.96	2.5
Cr K α	5414.7	3.91e+1	65.94	8.70	2.3
Mn K α	5898.8	3.15e+1	65.66	7.64	2.1
Co K α	6930.3	2.09e+1	64.75	5.97	1.8
Ni K α	7478.2	1.72e+1	64.04	5.30	1.7
Cu K α	8047.8	1.43e+1	62.94	4.72	1.5
Ge K α	9886.4	2.46e+0	61.72	9.99	1.3
Y K α	14988.0	1.16e+0	69.30	7.15	0.8
Mo K α	17479.0	7.73e-1	69.69	5.55	0.7
Pd K α	21177.0	4.62e-1	69.77	4.02	0.6
Sn K α	25271.0	2.86e-1	69.63	2.98	0.5
Xe K α	29779.0	1.83e-1	69.43	2.24	0.4

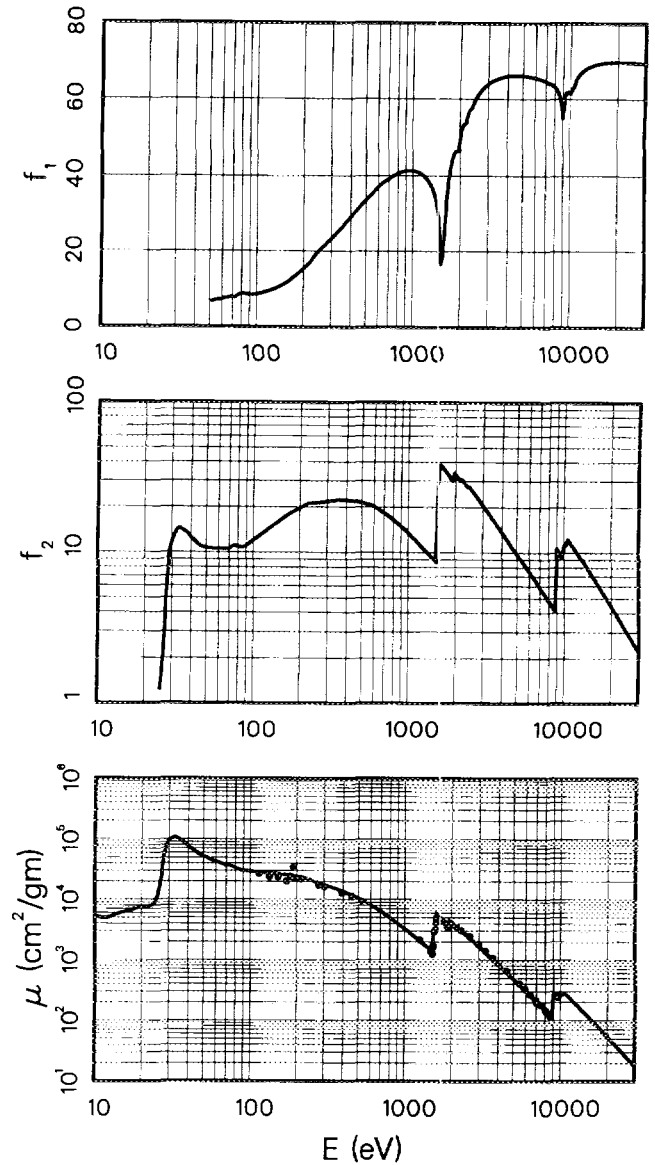

Edge Energies

L _I	10486.4 eV	M _I	2398.1 eV	N _I	480.5 eV ^a	O _I	52.0 eV ^a
L _{II}	9978.2 eV	M _{II}	2173.0 eV	N _{II}	388.7 eV ^a	O _{II}	30.3 eV ^a
L _{III}	8943.6 eV	M _{III}	1949.8 eV	N _{III}	339.7 eV ^a	O _{III}	24.1 eV ^a
		M _{IV}	1576.3 eV	N _{IV}	191.2 eV ^a		
		M _V	1527.8 eV	N _V	182.4 eV ^a		

References: 116, 131, 152.

TABLE I. Photoabsorption Cross Sections and Atomic Scattering Factors,
 $Z = 1-92$, $E = 50-30,000$ eV
 See page 211 for Explanation of Tables

Lutetium (Lu)

Z = 71

Atomic Weight = 174.967

$\mu_a(\text{barns/atom}) = \mu(\text{cm}^2/\text{gm}) \times 290.54$
 $E(\text{keV})\mu(\text{cm}^2/\text{gm}) = f_2 \times 240.49$

Line	E(eV)	$\mu(\text{cm}^2/\text{gm})$	f_1	f_2	$\lambda(\text{\AA})$
H	10.2	3.84e+4		1.63	1215
He I	21.2	7.85e+3		0.69	584.3
Na L _{2,3}	30.5	5.03e+4		6.37	407.2
Mg L _{2,3}	49.3	5.16e+4		10.58	251.5
Al L _{2,3}	72.4	3.10e+4	10.84	9.33	171.2
Si L _{2,3}	91.5	2.57e+4	10.94	9.77	135.5
Be K	108.5	2.32e+4	11.03	10.48	114.3
Sr M ζ	114.0	2.31e+4	10.99	10.93	108.8
Y M ζ	132.8	2.31e+4	11.35	12.78	93.4
Zr M ζ	151.1	2.32e+4	12.43	14.55	82.1
B K α	183.3	2.19e+4	14.39	16.68	67.6
Mo M ζ	192.6	2.16e+4	14.83	17.31	64.4
Ar L ℓ	220.1	2.12e+4	17.58	19.42	56.3
C K α	277.0	1.74e+4	21.47	20.08	44.8
Ag M ζ	311.7	1.61e+4	23.20	20.89	39.8
N K α	392.4	1.38e+4	27.91	22.56	31.6
Ti L α	452.2	1.17e+4	31.01	22.08	27.4
V L α	511.3	1.05e+4	33.53	22.33	24.2
O K α	524.9	1.02e+4	34.28	22.31	23.6
Cr L α	572.8	9.02e+3	36.50	21.47	21.6
Mn L α	637.4	7.64e+3	38.54	20.24	19.5
F K α	676.8	6.90e+3	39.46	19.42	18.3
Fe L α	705.0	6.47e+3	40.03	18.97	17.6
Co L α	776.2	5.48e+3	41.25	17.68	16.0
Ni L α	851.5	4.62e+3	42.04	16.35	14.6
Cu L α	929.7	3.92e+3	42.47	15.15	13.3
Zn L α	1011.7	3.33e+3	42.62	14.03	12.3
Na K α	1041.0	3.15e+3	42.60	13.63	11.9
Ge L α	1188.0	2.40e+3	41.66	11.83	10.4
Mg K α	1253.6	2.14e+3	40.81	11.17	9.9
Al K α	1486.7	1.50e+3	32.97	9.28	8.3
Si K α	1740.0	5.07e+3	39.33	36.65	7.1
Zr L α	2042.4	3.47e+3	51.32	29.46	6.1
Mo L α	2293.2	2.99e+3	52.59	28.52	5.4
Cl K α	2622.4	2.43e+3	60.32	26.46	4.7
Ag L α	2984.3	1.79e+3	63.83	22.17	4.2
Ca K α	3691.7	1.07e+3	66.38	16.40	3.4
Ti K α	4510.8	6.51e+2	67.12	12.22	2.7
V K α	4952.2	5.16e+2	67.14	10.62	2.5
Cr K α	5414.7	4.12e+2	67.02	9.28	2.3
Mn K α	5898.8	3.32e+2	66.79	8.15	2.1
Co K α	6930.3	2.21e+2	66.01	6.35	1.8
Ni K α	7478.2	1.81e+2	65.41	5.64	1.7
Cu K α	8047.8	1.50e+2	64.55	5.03	1.5
Ge K α	9886.4	2.33e+2	63.00	9.60	1.3
Y K α	14988.0	1.22e+2	70.05	7.59	0.8
Mo K α	17479.0	8.15e+1	70.59	5.92	0.7
Pd K α	21177.0	4.88e+1	70.76	4.30	0.6
Sn K α	25271.0	3.02e+1	70.66	3.17	0.5
Xe K α	29779.0	1.92e+1	70.47	2.38	0.4

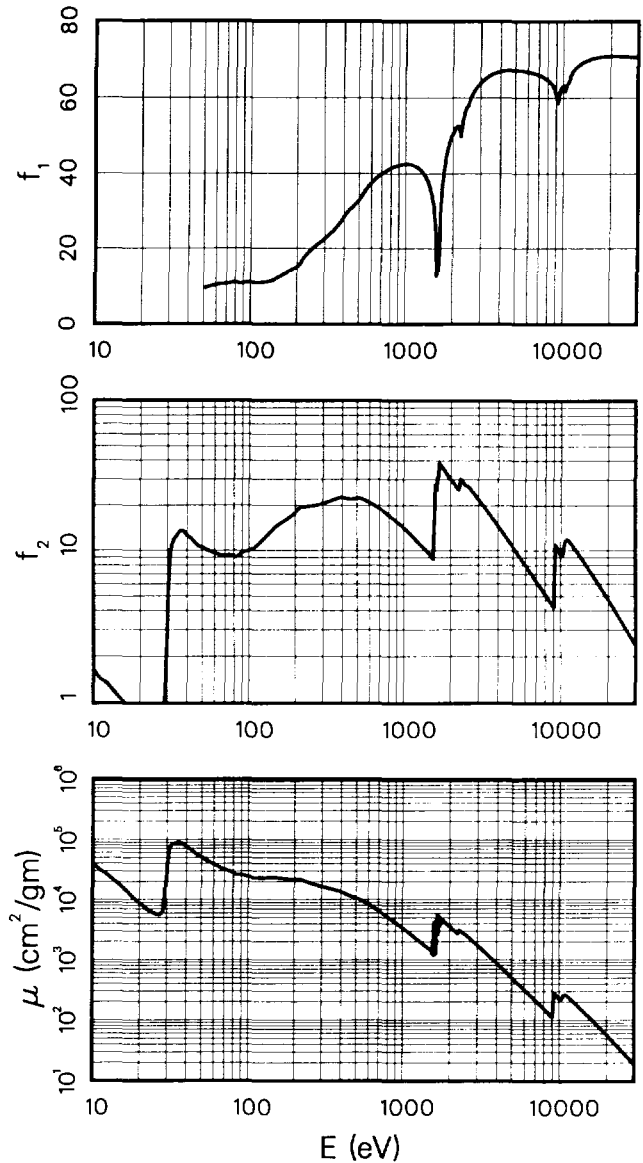

Edge Energies

L _I	10870.4 eV	M _I	2491.2 eV	N _I	506.8 eV ^a	O _I	57.3 eV ^a
L _{II}	10348.6 eV	M _{II}	2263.5 eV	N _{II}	412.4 eV ^a	O _{II}	33.6 eV ^a
L _{III}	9244.1 eV	M _{III}	2023.6 eV	N _{III}	359.2 eV ^a	O _{III}	26.7 eV ^a
		M _{IV}	1639.4 eV	N _{IV}	206.1 eV ^a		
		M _V	1588.5 eV	N _V	196.3 eV ^a		

References: 117.

TABLE I. Photoabsorption Cross Sections and Atomic Scattering Factors,
 $Z = 1-92$, $E = 50-30,000$ eV
 See page 211 for Explanation of Tables

$\mu_a(\text{barns/atom}) = \mu(\text{cm}^2/\text{gm}) \times 296.39$
 $E(\text{keV})\mu(\text{cm}^2/\text{gm}) = f_2 \times 235.75$

Hafnium (Hf)
 $Z = 72$

Atomic Weight = 178.490

Line	E(eV)	$\mu(\text{cm}^2/\text{gm})$	f_1	f_2	$\lambda(\text{\AA})$
H	10.2	6.32e + 4		2.74	1215
He I	21.2	2.87e + 4		2.58	584.3
Na L _{2,3}	30.5	2.08e + 4		2.69	407.2
Mg L _{2,3}	49.3	8.01e + 4		16.75	251.5
Al L _{2,3}	72.4	2.96e + 4	12.42	9.11	171.2
Si L _{2,3}	91.5	2.42e + 4	10.72	9.38	135.5
Be K	108.5	2.33e + 4	10.62	10.74	114.3
Sr M ζ	114.0	2.32e + 4	10.68	11.22	108.8
Y M ζ	132.8	2.28e + 4	11.20	12.87	93.4
Zr M ζ	151.1	2.25e + 4	12.00	14.39	82.1
B K α	183.3	2.18e + 4	13.82	16.95	67.6
Mo M ζ	192.6	2.15e + 4	14.50	17.58	64.4
Ar L l	220.1	2.06e + 4	16.56	19.19	56.3
C K α	277.0	1.82e + 4	20.89	21.43	44.8
Ag M ζ	311.7	1.64e + 4	23.66	21.71	39.8
N K α	392.4	1.32e + 4	27.71	21.97	31.6
Ti L α	452.2	1.16e + 4	30.35	22.24	27.4
V L α	511.3	1.02e + 4	32.68	22.10	24.2
O K α	524.9	9.95e + 3	33.13	22.15	23.6
Cr L α	572.8	9.17e + 3	35.13	22.29	21.6
Mn L α	637.4	7.99e + 3	37.84	21.60	19.5
F K α	676.8	7.23e + 3	39.06	20.75	18.3
Fe L α	705.0	6.78e + 3	39.79	20.27	17.6
Co L α	776.2	5.73e + 3	41.24	18.86	16.0
Ni L α	851.5	4.85e + 3	42.19	17.51	14.6
Cu L α	929.7	4.13e + 3	42.81	16.28	13.3
Zn L α	1011.7	3.51e + 3	43.13	15.07	12.3
Na K α	1041.0	3.32e + 3	43.16	14.64	11.9
Ge L α	1188.0	2.53e + 3	42.52	12.75	10.4
Mg K α	1253.6	2.27e + 3	41.85	12.05	9.9
Al K α	1486.7	1.59e + 3	36.17	10.06	8.3
Si K α	1740.0	5.34e + 3	33.15	39.40	7.1
Zr L α	2042.4	3.60e + 3	49.49	31.19	6.1
Mo L α	2293.2	3.13e + 3	55.89	30.44	5.4
Cl K α	2622.4	2.48e + 3	60.92	27.61	4.7
Ag L α	2984.3	1.83e + 3	65.04	23.18	4.2
Ca K α	3691.7	1.08e + 3	67.51	16.96	3.4
Ti K α	4510.8	6.62e + 2	68.19	12.67	2.7
V K α	4952.2	5.26e + 2	68.22	11.06	2.5
Cr K α	5414.7	4.22e + 2	68.12	9.69	2.3
Mn K α	5898.8	3.41e + 2	67.93	8.54	2.1
Co K α	6930.3	2.27e + 2	67.27	6.68	1.8
Ni K α	7478.2	1.87e + 2	66.77	5.93	1.7
Cu K α	8047.8	1.55e + 2	66.07	5.28	1.5
Ge K α	9886.4	2.41e + 2	62.67	10.09	1.3
Y K α	14988.0	1.25e + 2	70.92	7.97	0.8
Mo K α	17479.0	8.35e + 1	71.54	6.19	0.7
Pd K α	21177.0	4.99e + 1	71.73	4.48	0.6
Sn K α	25271.0	3.09e + 1	71.65	3.32	0.5
Xe K α	29779.0	1.98e + 1	71.47	2.50	0.4

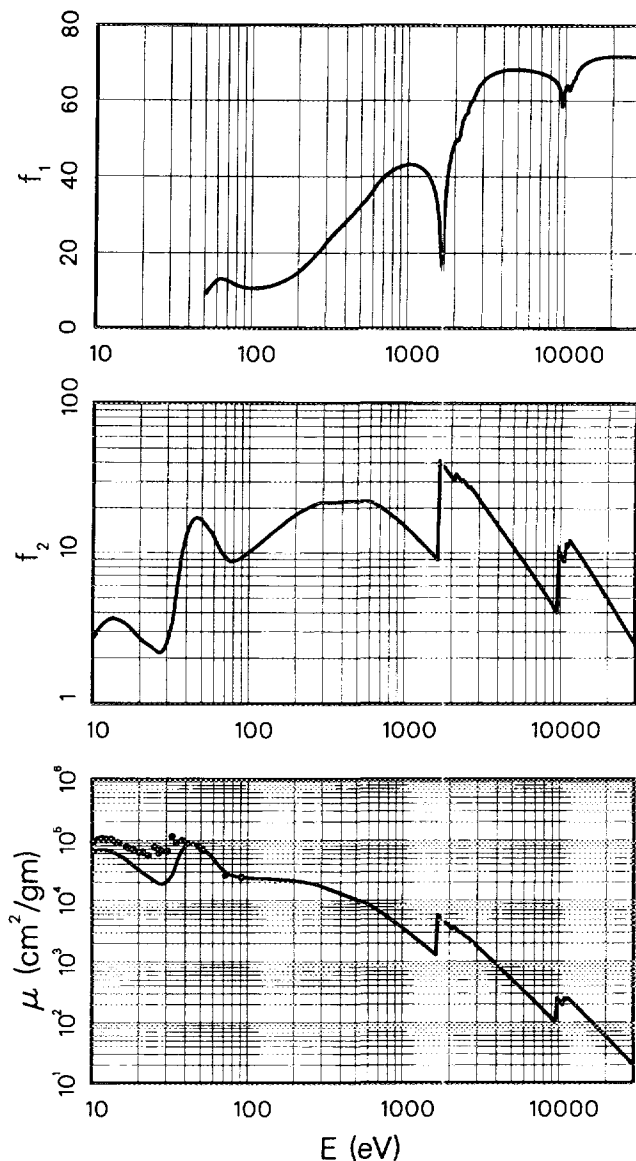

Edge Energies

L _I 11270.7 eV	M _I 2600.9 eV	N _I 538. eV ^a	O _I 64.2 eV ^b
L _{II} 10739.4 eV	M _{II} 2365.4 eV	N _{II} 438.2 eV ^b	O _{II} 38. eV ^a
L _{III} 9560.7 eV	M _{III} 2107.6 eV	N _{III} 380.7 eV ^b	O _{III} 29.9 eV ^b
	M _{IV} 1716.4 eV	N _{IV} 220.0 eV ^b	
	M _V 1661.7 eV	N _V 211.5 eV ^b	
		N _{VI} 15.9 eV ^b	
		N _{VII} 14.2 eV ^b	

References: 76, 232.

TABLE I. Photoabsorption Cross Sections and Atomic Scattering Factors.
 $Z = 1-92, E = 50-30,000 \text{ eV}$
 See page 211 for Explanation of Tables

$\mu_a(\text{barns/atom}) = \mu(\text{cm}^2/\text{gm}) \times 300.48$
 $E(\text{keV})\mu(\text{cm}^2/\text{gm}) = f_2 \times 232.54$

Tantalum (Ta)
 $Z = 73$
 Atomic Weight = 180.948

Line	E(eV)	$\mu(\text{cm}^2/\text{gm})$	f_1	f_2	$\lambda(\text{\AA})$
H	10.2	7.48e+4		3.28	1215
He I	21.2	6.51e+4		5.94	584.3
Na L _{2,3}	30.5	3.51e+4		4.59	407.2
Mg L _{2,3}	49.3	8.38e+4		17.76	251.5
Al L _{2,3}	72.4	3.25e+4	14.03	10.13	171.2
Si L _{2,3}	91.5	2.29e+4	12.62	9.01	135.5
Be K	108.5	2.10e+4	11.56	9.78	114.3
Sr M ζ	114.0	2.09e+4	11.37	10.24	108.8
Y M ζ	132.8	2.13e+4	11.58	12.16	93.4
Zr M ζ	151.1	2.11e+4	12.17	13.70	82.1
B K α	183.3	2.08e+4	13.49	16.41	67.6
Mo M ζ	192.6	2.08e+4	14.11	17.25	64.4
Ar L ℓ	220.1	2.01e+4	16.17	19.06	56.3
C K α	277.0	1.83e+4	20.55	21.81	44.8
Ag M ζ	311.7	1.65e+4	23.19	22.15	39.8
N K α	392.4	1.34e+4	27.04	22.68	31.6
Ti L α	452.2	1.25e+4	30.12	24.37	27.4
V L α	511.3	1.09e+4	33.53	23.94	24.2
O K α	524.9	1.05e+4	34.12	23.79	23.6
Cr L α	572.8	9.77e+3	35.75	24.06	21.6
Mn L α	637.4	8.39e+3	39.12	22.98	19.5
F K α	676.8	7.59e+3	40.36	22.09	18.3
Fe L α	705.0	7.12e+3	41.13	21.59	17.6
Co L α	776.2	6.04e+3	42.77	20.15	16.0
Ni L α	851.5	5.12e+3	43.93	18.73	14.6
Cu L α	929.7	4.35e+3	44.75	17.40	13.3
Zn L α	1011.7	3.70e+3	45.26	16.08	12.3
Na K α	1041.0	3.49e+3	45.36	15.63	11.9
Ge L α	1188.0	2.67e+3	45.19	13.65	10.4
Mg K α	1253.6	2.39e+3	44.84	12.90	9.9
Al K α	1486.7	1.67e+3	41.46	10.65	8.3
Si K α	1740.0	1.69e+3	21.23	12.63	7.1
Zr L α	2042.4	3.74e+3	48.43	32.87	6.1
Mo L α	2293.2	3.27e+3	54.76	32.28	5.4
Cl K α	2622.4	2.48e+3	60.87	28.02	4.7
Ag L α	2984.3	1.90e+3	64.97	24.33	4.2
Ca K α	3691.7	1.13e+3	68.29	17.98	3.4
Ti K α	4510.8	6.89e+2	69.33	13.36	2.7
V K α	4952.2	5.45e+2	69.43	11.60	2.5
Cr K α	5414.7	4.35e+2	69.38	10.12	2.3
Mn K α	5898.8	3.50e+2	69.23	8.88	2.1
Co K α	6930.3	2.32e+2	68.63	6.92	1.8
Ni K α	7478.2	1.91e+2	68.18	6.14	1.7
Cu K α	8047.8	1.58e+2	67.61	5.48	1.5
Ge K α	9886.4	1.15e+2	62.10	4.88	1.3
Y K α	14988.0	1.30e+2	71.45	8.37	0.8
Mo K α	17479.0	8.73e+1	72.29	6.56	0.7
Pd K α	21177.0	5.25e+1	72.64	4.78	0.6
Sn K α	25271.0	3.26e+1	72.62	3.54	0.5
Xe K α	29779.0	2.08e+1	72.48	2.67	0.4

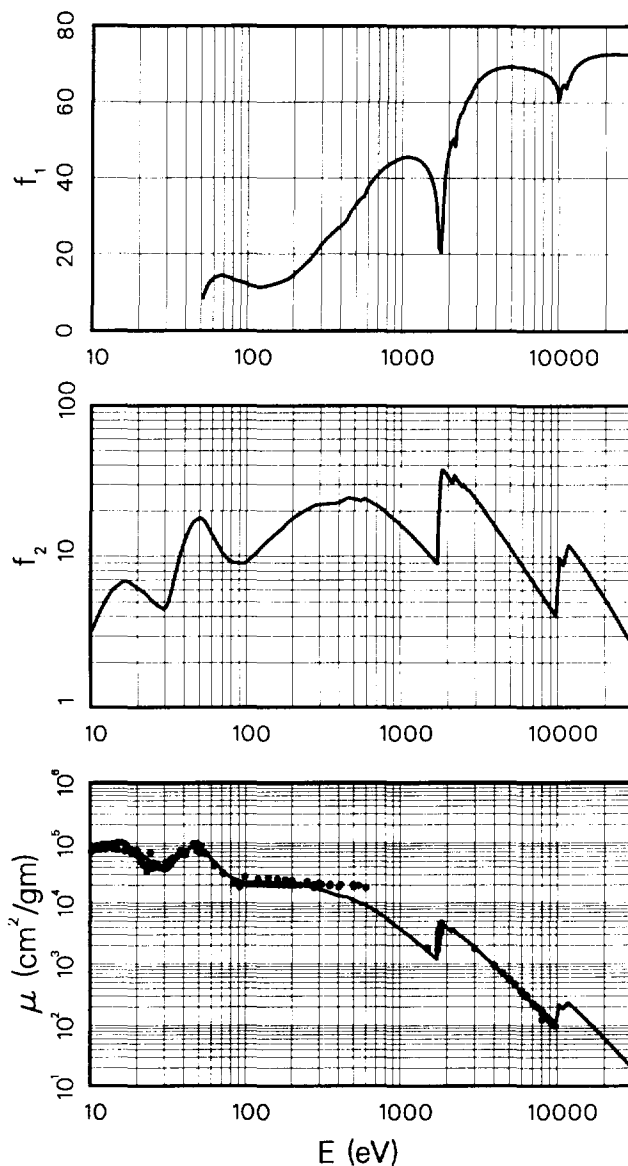

Edge Energies

L _I	11681.5 eV	M _I	2708.0 eV	N _I	563.4 eV ^b	O _I	69.7 eV ^b
L _{II}	11136.1 eV	M _{II}	2468.7 eV	N _{II}	463.4 eV ^b	O _{II}	42.2 eV ^a
L _{III}	9881.1 eV	M _{III}	2194.0 eV	N _{III}	400.9 eV ^b	O _{III}	32.7 eV ^b
		M _{IV}	1793.2 eV	N _{IV}	237.9 eV ^b		
		M _V	1735.1 eV	N _V	226.4 eV ^b		
				N _{VI}	23.5 eV ^b		
				N _{VII}	21.6 eV ^b		

References: 98, 99, 117, 123, 125, 131, 136, 177, 200, 223, 229, 232.

TABLE I. Photoabsorption Cross Sections and Atomic Scattering Factors,
 $Z = 1-92$, $E = 50-30,000$ eV
 See page 211 for Explanation of Tables

$\mu_a(\text{barns/atom}) = \mu(\text{cm}^2/\text{gm}) \times 305.29$
 $E(\text{keV})\mu(\text{cm}^2/\text{gm}) = f_2 \times 228.87$

Tungsten (W)
 $Z = 74$
 Atomic Weight = 183.850

Line	E(eV)	$\mu(\text{cm}^2/\text{gm})$	f_1	f_2	$\lambda(\text{\AA})$
H	10.2	4.55e+4		2.03	1215
He I	21.2	6.11e+4		5.67	584.3
Na L _{2,3}	30.5	3.11e+4		4.14	407.2
Mg L _{2,3}	49.3	7.90e+4		17.01	251.5
Al L _{2,3}	72.4	3.27e+4	14.72	10.34	171.2
Si L _{2,3}	91.5	2.04e+4	13.26	8.15	135.5
Be K	108.5	1.80e+4	11.60	8.54	114.3
Sr M ζ	114.0	1.83e+4	11.26	9.09	108.8
Y M ζ	132.8	1.91e+4	11.08	11.06	93.4
Zr M ζ	151.1	1.91e+4	11.52	12.63	82.1
B K α	183.3	1.94e+4	12.69	15.55	67.6
Mo M ζ	192.6	1.94e+4	13.08	16.29	64.4
Ar L ℓ	220.1	1.92e+4	14.54	18.47	56.3
C K α	277.0	1.84e+4	19.09	22.30	44.8
Ag M ζ	311.7	1.69e+4	21.81	23.02	39.8
N K α	392.4	1.42e+4	26.30	24.30	31.6
Ti L α	452.2	1.30e+4	29.93	25.61	27.4
V L α	511.3	1.13e+4	33.54	25.28	24.2
O K α	524.9	1.10e+4	34.26	25.15	23.6
Cr L α	572.8	9.77e+3	36.22	24.44	21.6
Mn L α	637.4	8.73e+3	38.86	24.31	19.5
F K α	676.8	7.93e+3	40.51	23.45	18.3
Fe L α	705.0	7.44e+3	41.41	22.93	17.6
Co L α	776.2	6.32e+3	43.31	21.44	16.0
Ni L α	851.5	5.35e+3	44.67	19.89	14.6
Cu L α	929.7	4.54e+3	45.61	18.45	13.3
Zn L α	1011.7	3.87e+3	46.24	17.09	12.3
Na K α	1041.0	3.65e+3	46.39	16.62	11.9
Ge L α	1188.0	2.80e+3	46.51	14.56	10.4
Mg K α	1253.6	2.52e+3	46.31	13.78	9.9
Al K α	1486.7	1.75e+3	43.89	11.38	8.3
Si K α	1740.0	1.25e+3	33.20	9.48	7.1
Zr L α	2042.4	3.89e+3	46.31	34.70	6.1
Mo L α	2293.2	3.24e+3	52.07	32.46	5.4
Cl K α	2622.4	2.59e+3	60.06	29.63	4.7
Ag L α	2984.3	1.97e+3	64.90	25.67	4.2
Ca K α	3691.7	1.17e+3	68.89	18.94	3.4
Ti K α	4510.8	7.15e+2	70.16	14.09	2.7
V K α	4952.2	5.66e+2	70.33	12.24	2.5
Cr K α	5414.7	4.52e+2	70.33	10.69	2.3
Mn K α	5898.8	3.64e+2	70.19	9.37	2.1
Co K α	6930.3	2.41e+2	69.64	7.30	1.8
Ni K α	7478.2	1.98e+2	69.24	6.48	1.7
Cu K α	8047.8	1.64e+2	68.73	5.77	1.5
Ge K α	9886.4	9.64e+1	64.15	4.17	1.3
Y K α	14988.0	1.35e+2	72.33	8.81	0.8
Mo K α	17479.0	8.99e+1	73.26	6.87	0.7
Pd K α	21177.0	5.40e+1	73.63	5.00	0.6
Sn K α	25271.0	3.36e+1	73.63	3.71	0.5
Xe K α	29779.0	2.15e+1	73.48	2.80	0.4

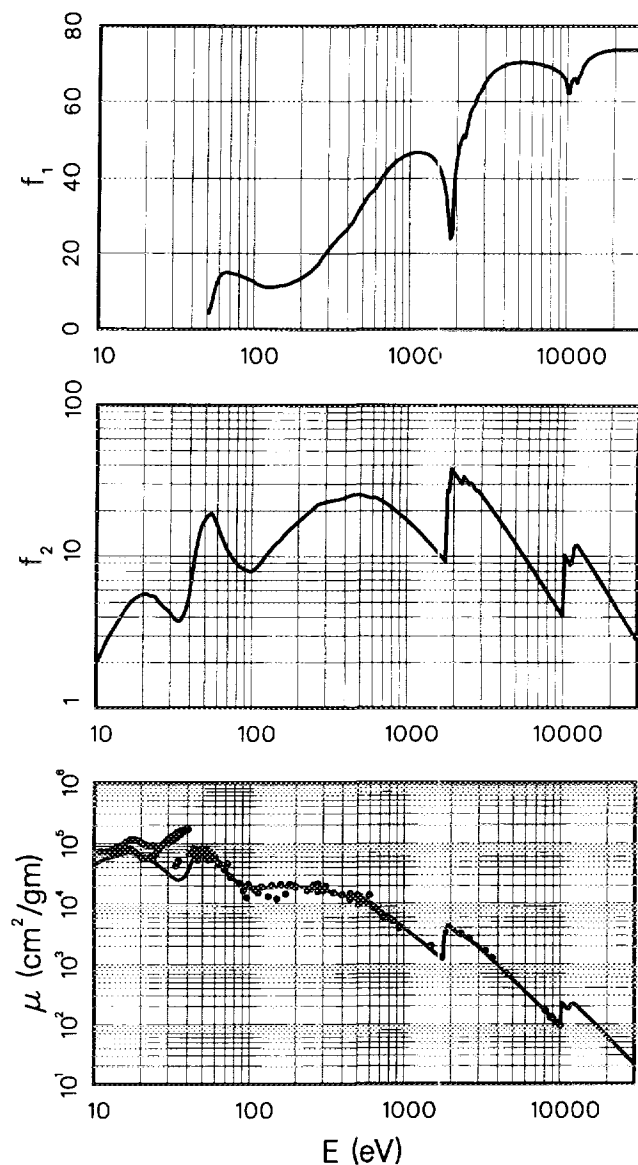

Edge Energies

L _I	12099.8 eV	M _I	2819.6 eV	N _I	594.1 eV ^b	O _I	75.6 eV ^b
L _{II}	11544.0 eV	M _{II}	2574.9 eV	N _{II}	490.4 eV ^b	O _{II}	45.3 eV ^a
L _{III}	10206.8 eV	M _{III}	2281.0 eV	N _{III}	423.6 eV ^b	O _{III}	36.8 eV ^b
		M _{IV}	1871.6 eV	N _{IV}	255.9 eV ^b		
		M _V	1809.2 eV	N _V	243.5 eV ^b		
				N _{VI}	33.6 eV ^a		
				N _{VII}	31.4 eV ^b		

References: 4, 48, 106, 136, 149, 200, 223, 233.

TABLE I. Photoabsorption Cross Sections and Atomic Scattering Factors.

$Z = 1-92$, $E = 50-30,000$ eV

See page 211 for Explanation of Tables

$\mu_a(\text{barns/atom}) = \mu(\text{cm}^2/\text{gm}) \times 309.21$
 $E(\text{keV})\mu(\text{cm}^2/\text{gm}) = f_2 \times 225.98$

Rhenium (Re)
 $Z = 75$
 Atomic Weight = 186.207

Line	E(eV)	$\mu(\text{cm}^2/\text{gm})$	f_1	f_2	$\lambda(\text{\AA})$
H	10.2	4.28e+4		1.93	1215
He I	21.2	8.06e+4		7.57	584.3
Na L _{2,3}	30.5	3.45e+4		4.65	407.2
Mg L _{2,3}	49.3	5.70e+4		12.44	251.5
Al L _{2,3}	72.4	3.54e+4	16.54	11.35	171.2
Si L _{2,3}	91.5	1.78e+4	15.11	7.21	135.5
Be K	108.5	1.56e+4	12.84	7.49	114.3
Sr M ζ	114.0	1.59e+4	12.39	8.02	108.8
Y M ζ	132.8	1.70e+4	11.95	9.97	93.4
Zr M ζ	151.1	1.75e+4	12.31	11.73	82.1
B K α	183.3	1.76e+4	13.07	14.29	67.6
Mo M ζ	192.6	1.76e+4	13.40	15.01	64.4
Ar L ℓ	220.1	1.77e+4	14.47	17.21	56.3
C K α	277.0	1.74e+4	18.22	21.31	44.8
Ag M ζ	311.7	1.64e+4	20.74	22.63	39.8
N K α	392.4	1.42e+4	26.12	24.61	31.6
Ti L α	452.2	1.27e+4	29.33	25.40	27.4
V L α	511.3	1.15e+4	32.54	26.00	24.2
O K α	524.9	1.12e+4	33.39	26.13	23.6
Cr L α	572.8	1.01e+4	35.83	25.48	21.6
Mn L α	637.4	9.09e+3	38.87	25.65	19.5
F K α	676.8	8.23e+3	40.81	24.66	18.3
Fe L α	705.0	7.71e+3	41.77	24.07	17.6
Co L α	776.2	6.56e+3	43.81	22.53	16.0
Ni L α	851.5	5.56e+3	45.33	20.96	14.6
Cu L α	929.7	4.74e+3	46.44	19.51	13.3
Zn L α	1011.7	4.05e+3	47.26	18.12	12.3
Na K α	1041.0	3.83e+3	47.48	17.63	11.9
Ge L α	1188.0	2.94e+3	47.90	15.45	10.4
Mg K α	1253.6	2.64e+3	47.84	14.62	9.9
Al K α	1486.7	1.84e+3	46.17	12.10	8.3
Si K α	1740.0	1.31e+3	39.87	10.11	7.1
Zr L α	2042.4	4.00e+3	42.11	36.18	6.1
Mo L α	2293.2	3.03e+3	52.05	30.79	5.4
Cl K α	2622.4	2.52e+3	59.53	29.28	4.7
Ag L α	2984.3	2.04e+3	64.28	26.95	4.2
Ca K α	3691.7	1.22e+3	69.43	19.94	3.4
Ti K α	4510.8	7.43e+2	71.00	14.84	2.7
V K α	4952.2	5.88e+2	71.25	12.89	2.5
Cr K α	5414.7	4.70e+2	71.31	11.26	2.3
Mn K α	5898.8	3.78e+2	71.21	9.87	2.1
Co K α	6930.3	2.51e+2	70.74	7.69	1.8
Ni K α	7478.2	2.06e+2	70.38	6.83	1.7
Cu K α	8047.8	1.71e+2	69.93	6.08	1.5
Ge K α	9886.4	1.01e+2	66.94	4.41	1.3
Y K α	14988.0	1.40e+2	72.89	9.27	0.8
Mo K α	17479.0	9.40e+1	74.05	7.27	0.7
Pd K α	21177.0	5.67e+1	74.57	5.31	0.6
Sn K α	25271.0	3.53e+1	74.62	3.94	0.5
Xe K α	29779.0	2.26e+1	74.50	2.98	0.4

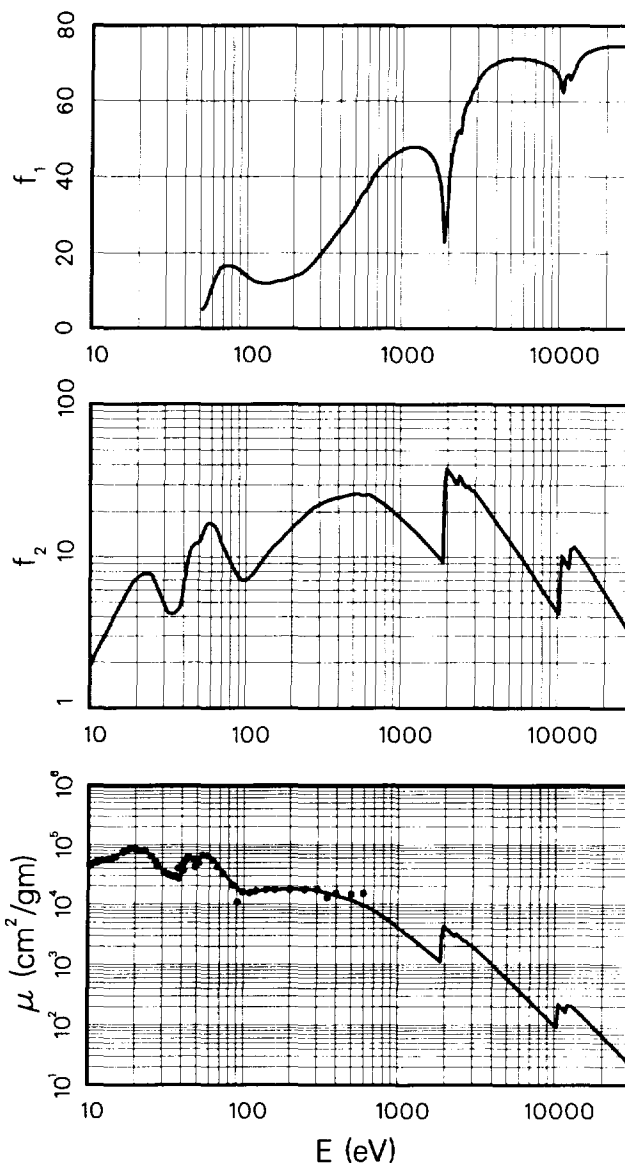

Edge Energies

L _I	12526.7 eV	M _I	2931.7 eV	N _I	625.4 eV ^b	O _I	83. eV ^b
L _{II}	11958.7 eV	M _{II}	2681.6 eV	N _{II}	518.7 eV ^b	O _{II}	45.6 eV ^b
L _{III}	10535.3 eV	M _{III}	2367.3 eV	N _{III}	446.8 eV ^b	O _{III}	34.6 eV ^b
		M _{IV}	1948.9 eV	N _{IV}	273.9 eV ^b		
		M _V	1882.9 eV	N _V	260.5 eV ^b		
				N _{VI}	42.9 eV ^a		
				N _{VII}	40.5 eV ^a		

References: 136, 232.

TABLE I. Photoabsorption Cross Sections and Atomic Scattering Factors,
 $Z = 1-92$, $E = 50-30,000$ eV

See page 211 for Explanation of Tables

μ_a (barns/atom) = μ (cm²/gm) \times 315.84
 E (keV) μ (cm²/gm) = $f_2 \times 221.23$

Osmium (Os)
 $Z = 76$
 Atomic Weight = 190.200

Line	E(eV)	μ (cm ² /gm)	f_1	f_2	λ (Å)
H	10.2	4.23e + 4		1.95	1215
He I	21.2	8.08e + 4		7.75	584.3
Na L _{2,3}	30.5	5.80e + 4		7.99	407.2
Mg L _{2,3}	49.3	4.95e + 4		11.03	251.5
Al L _{2,3}	72.4	3.39e + 4	15.91	11.10	171.2
Si L _{2,3}	91.5	1.81e + 4	16.42	7.50	135.5
Be K	108.5	1.38e + 4	14.45	6.75	114.3
Sr M ζ	114.0	1.34e + 4	13.86	6.93	108.8
Y M ζ	132.8	1.42e + 4	12.52	8.49	93.4
Zr M ζ	151.1	1.54e + 4	12.10	10.51	82.1
B K α	183.3	1.67e + 4	13.03	13.83	67.6
Mo M ζ	192.6	1.67e + 4	13.37	14.55	64.4
Ar L ℓ	220.1	1.69e + 4	14.36	16.83	56.3
C K α	277.0	1.70e + 4	18.08	21.28	44.8
Ag M ζ	311.7	1.60e + 4	20.71	22.54	39.8
N K α	392.4	1.41e + 4	26.06	24.98	31.6
Ti L α	452.2	1.22e + 4	29.23	24.98	27.4
V L α	511.3	1.15e + 4	32.04	26.49	24.2
O K α	524.9	1.13e + 4	33.03	26.72	23.6
Cr L α	572.8	1.02e + 4	36.04	26.28	21.6
Mn L α	637.4	8.83e + 3	38.48	25.43	19.5
F K α	676.8	8.40e + 3	40.13	25.70	18.3
Fe L α	705.0	7.91e + 3	41.57	25.20	17.6
Co L α	776.2	6.75e + 3	44.02	23.69	16.0
Ni L α	851.5	5.75e + 3	45.83	22.14	14.6
Cu L α	929.7	4.91e + 3	47.21	20.65	13.3
Zn L α	1011.7	4.19e + 3	48.23	19.15	12.3
Na K α	1041.0	3.96e + 3	48.50	18.63	11.9
Ge L α	1188.0	3.04e + 3	49.16	16.32	10.4
Mg K α	1253.6	2.73e + 3	49.20	15.45	9.9
Al K α	1486.7	1.92e + 3	48.13	12.87	8.3
Si K α	1740.0	1.37e + 3	43.94	10.80	7.1
Zr L α	2042.4	3.16e + 3	30.57	29.17	6.1
Mo L α	2293.2	3.12e + 3	51.64	32.30	5.4
Cl K α	2622.4	2.61e + 3	59.25	30.89	4.7
Ag L α	2984.3	2.01e + 3	64.15	27.12	4.2
Ca K α	3691.7	1.26e + 3	69.94	20.95	3.4
Ti K α	4510.8	7.66e + 2	71.85	15.62	2.7
V K α	4952.2	6.07e + 2	72.19	13.58	2.5
Cr K α	5414.7	4.85e + 2	72.32	11.87	2.3
Mn K α	5898.8	3.91e + 2	72.29	10.41	2.1
Co K α	6930.3	2.59e + 2	71.91	8.12	1.8
Ni K α	7478.2	2.13e + 2	71.60	7.21	1.7
Cu K α	8047.8	1.77e + 2	71.20	6.43	1.5
Ge K α	9886.4	1.04e + 2	68.91	4.64	1.3
Y K α	14988.0	1.44e + 2	73.43	9.74	0.8
Mo K α	17479.0	9.65e + 1	74.85	7.63	0.7
Pd K α	21177.0	5.81e + 1	75.49	5.57	0.6
Sn K α	25271.0	3.62e + 1	75.58	4.14	0.5
Xe K α	29779.0	2.33e + 1	75.49	3.13	0.4

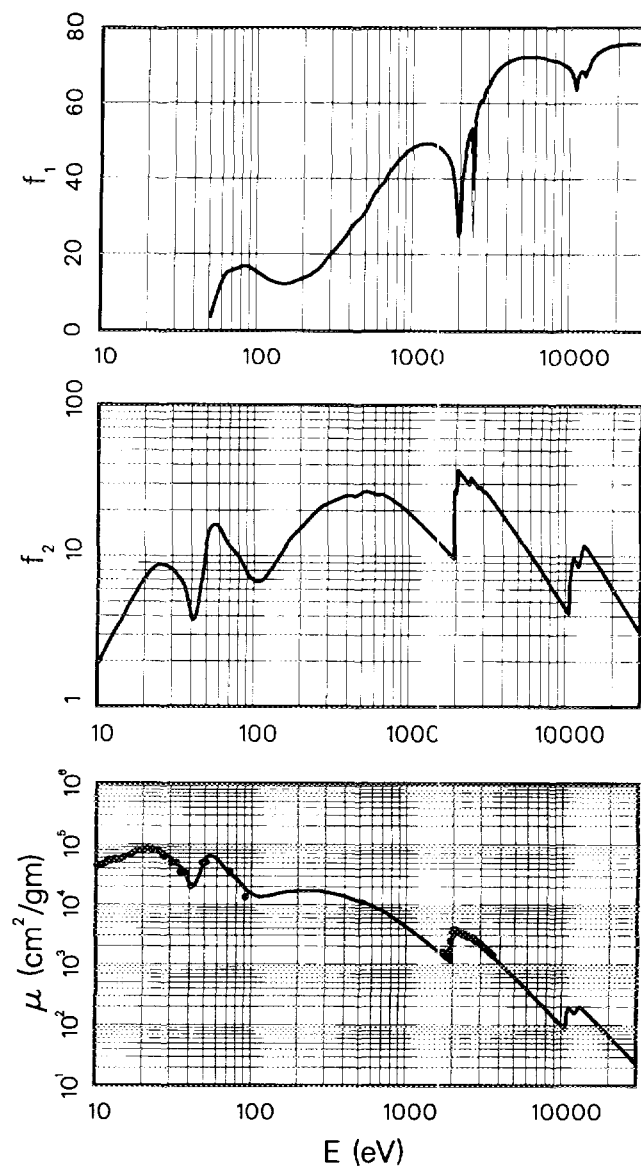

Edge Energies

L _I 12968.0 eV	M _I 3048.5 eV	N _I 653.2 eV ^b	O _I 84. eV ^a
L _{II} 12385.0 eV	M _{II} 2792.2 eV	N _{II} 543.1 eV ^b	O _{II} 58. eV ^a
L _{III} 10870.9 eV	M _{III} 2457.2 eV	N _{III} 473.7 eV ^b	O _{III} 44.5 eV ^b
	M _{IV} 2030.8 eV	N _{IV} 293.1 eV ^b	
	M _V 1960.1 eV	N _V 273.5 eV ^b	
		N _{VI} 53.4 eV ^b	
		N _{VII} 50.7 eV ^b	

References: 193, 232.

TABLE I. Photoabsorption Cross Sections and Atomic Scattering Factors,

$Z = 1-92, E = 50-30,000 \text{ eV}$

See page 211 for Explanation of Tables

$\mu_a(\text{barns/atom}) = \mu(\text{cm}^2/\text{gm}) \times 319.19$
 $E(\text{keV})\mu(\text{cm}^2/\text{gm}) = f_2 \times 218.91$

Iridium (Ir)
 $Z = 77$
 Atomic Weight = 192.220

Line	E(eV)	$\mu(\text{cm}^2/\text{gm})$	f_1	f_2	$\lambda(\text{\AA})$
H	10.2	4.99e+4		2.33	1215
He I	21.2	8.55e+4		8.29	584.3
Na L _{2,3}	30.5	6.73e+4		9.36	407.2
Mg L _{2,3}	49.3	5.55e+4		12.49	251.5
Al L _{2,3}	72.4	4.00e+4	16.37	13.23	171.2
Si L _{2,3}	91.5	1.89e+4	18.15	7.90	135.5
Be K	108.5	1.10e+4	16.37	5.44	114.3
Sr M ζ	114.0	1.01e+4	15.55	5.24	108.8
Y M ζ	132.8	9.66e+3	13.10	5.86	93.4
Zr M ζ	151.1	1.11e+4	11.63	7.66	82.1
B K α	183.3	1.37e+4	10.82	11.45	67.6
Mo M ζ	192.6	1.43e+4	10.91	12.59	64.4
Ar L ℓ	220.1	1.56e+4	11.76	15.71	56.3
C K α	277.0	1.65e+4	15.07	20.91	44.8
Ag M ζ	311.7	1.63e+4	17.56	23.23	39.8
N K α	392.4	1.49e+4	23.57	26.66	31.6
Ti L α	452.2	1.36e+4	27.83	28.01	27.4
V L α	511.3	1.22e+4	31.71	28.55	24.2
O K α	524.9	1.19e+4	32.56	28.60	23.6
Cr L α	572.8	1.09e+4	35.40	28.57	21.6
Mn L α	637.4	9.62e+3	38.88	28.02	19.5
F K α	676.8	8.86e+3	40.82	27.40	18.3
Fe L α	705.0	8.34e+3	41.98	26.84	17.6
Co L α	776.2	7.16e+3	44.53	25.38	16.0
Ni L α	851.5	6.10e+3	46.47	23.75	14.6
Cu L α	929.7	5.22e+3	48.00	22.18	13.3
Zn L α	1011.7	4.46e+3	49.19	20.59	12.3
Na K α	1041.0	4.21e+3	49.52	20.03	11.9
Ge L α	1188.0	3.23e+3	50.41	17.54	10.4
Mg K α	1253.6	2.90e+3	50.55	16.61	9.9
Al K α	1486.7	2.04e+3	49.92	13.82	8.3
Si K α	1740.0	1.46e+3	46.92	11.58	7.1
Zr L α	2042.4	1.43e+3	28.21	13.30	6.1
Mo L α	2293.2	3.27e+3	49.55	34.29	5.4
Cl K α	2622.4	2.74e+3	57.29	32.83	4.7
Ag L α	2984.3	2.11e+3	63.80	28.81	4.2
Ca K α	3691.7	1.32e+3	70.34	22.25	3.4
Ti K α	4510.8	8.08e+2	72.74	16.64	2.7
V K α	4952.2	6.40e+2	73.21	14.47	2.5
Cr K α	5414.7	5.11e+2	73.42	12.63	2.3
Mn K α	5898.8	4.11e+2	73.45	11.07	2.1
Co K α	6930.3	2.72e+2	73.15	8.61	1.8
Ni K α	7478.2	2.24e+2	72.87	7.64	1.7
Cu K α	8047.8	1.85e+2	72.51	6.81	1.5
Ge K α	9886.4	1.09e+2	70.67	4.92	1.3
Y K α	14988.0	1.47e+2	73.90	10.09	0.8
Mo K α	17479.0	9.96e+1	75.58	7.95	0.7
Pd K α	21177.0	6.04e+1	76.36	5.84	0.6
Sn K α	25271.0	3.78e+1	76.52	4.36	0.5
Xe K α	29779.0	2.43e+1	76.48	3.31	0.4

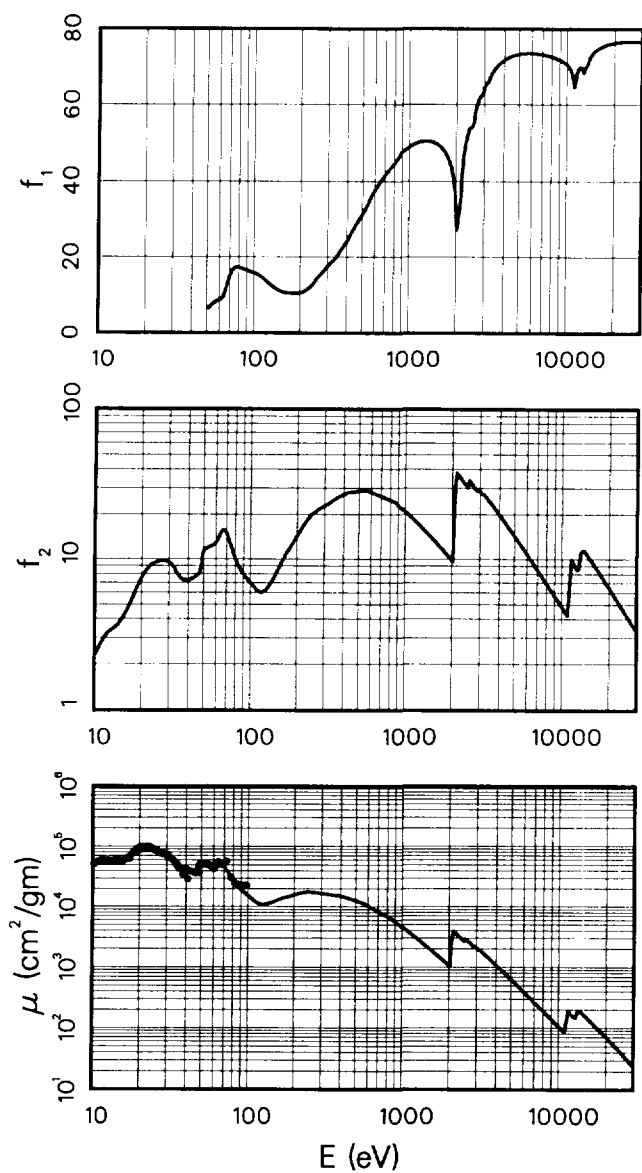

Edge Energies

L _I 13418.5 eV	M _I 3173.7 eV	N _I 691.1 eV ^b	O _I 95.2 eV ^a
L _{II} 12824.1 eV	M _{II} 2908.7 eV	N _{II} 577.8 eV ^b	O _{II} 63.0 eV ^a
L _{III} 11215.2 eV	M _{III} 2550.7 eV	N _{III} 495.8 eV ^b	O _{III} 48.0 eV ^b
	M _{IV} 2116.1 eV	N _{IV} 311.9 eV ^b	
	M _V 2040.4 eV	N _V 296.3 eV ^b	
		N _{VI} 63.8 eV ^b	
		N _{VII} 60.8 eV ^b	

References: 183, 223, 232.

TABLE I. Photoabsorption Cross Sections and Atomic Scattering Factors,
 $Z = 1-92$, $E = 50-30,000$ eV
 See page 211 for Explanation of Tables

Platinum (Pt)
 $Z = 78$

Atomic Weight = 195.080

$\mu_a(\text{barns/atom}) = \mu(\text{cm}^2/\text{gm}) \times 323.94$
 $E(\text{keV})\mu(\text{cm}^2/\text{gm}) = f_2 \times 215.70$

Line	E(eV)	$\mu(\text{cm}^2/\text{gm})$	f_1	f_2	$\lambda(\text{\AA})$
H	10.2	4.84e+4		2.29	1215
He I	21.2	9.63e+4		9.48	584.3
Na L _{2,3}	30.5	7.26e+4		10.25	407.2
Mg L _{2,3}	49.3	4.34e+4		9.92	251.5
Al L _{2,3}	72.4	5.64e+4	11.68	18.94	171.2
Si L _{2,3}	91.5	2.65e+4	20.14	11.24	135.5
Be K	108.5	1.47e+4	18.47	7.42	114.3
Sr M ζ	114.0	1.27e+4	17.87	6.72	108.8
Y M ζ	132.8	9.52e+3	15.10	5.86	93.4
Zr M ζ	151.1	9.70e+3	12.86	6.80	82.1
B K α	183.3	1.27e+4	10.77	10.76	67.6
Mo M ζ	192.6	1.34e+4	10.80	12.00	64.4
Ar L ℓ	220.1	1.53e+4	11.11	15.59	56.3
C K α	277.0	1.61e+4	15.18	20.66	44.8
Ag M ζ	311.7	1.58e+4	17.14	22.77	39.8
N K α	392.4	1.51e+4	23.12	27.52	31.6
Ti L α	452.2	1.33e+4	27.99	27.89	27.4
V L α	511.3	1.17e+4	30.83	27.68	24.2
O K α	524.9	1.15e+4	31.10	27.87	23.6
Cr L α	572.8	1.11e+4	34.20	29.53	21.6
Mn L α	637.4	9.75e+3	38.29	28.80	19.5
F K α	676.8	8.90e+3	40.06	27.92	18.3
Fe L α	705.0	8.42e+3	40.92	27.53	17.6
Co L α	776.2	7.57e+3	43.68	27.23	16.0
Ni L α	851.5	6.45e+3	46.46	25.46	14.6
Cu L α	929.7	5.50e+3	48.30	23.73	13.3
Zn L α	1011.7	4.70e+3	49.71	22.03	12.3
Na K α	1041.0	4.44e+3	50.11	21.44	11.9
Ge L α	1188.0	3.41e+3	51.29	18.79	10.4
Mg K α	1253.6	3.06e+3	51.55	17.79	9.9
Al K α	1486.7	2.15e+3	51.36	14.82	8.3
Si K α	1740.0	1.54e+3	49.22	12.41	7.1
Zr L α	2042.4	1.08e+3	38.77	10.23	6.1
Mo L α	2293.2	3.42e+3	44.93	36.36	5.4
Cl K α	2622.4	2.47e+3	52.30	29.99	4.7
Ag L α	2984.3	2.08e+3	62.95	28.72	4.2
Ca K α	3691.7	1.37e+3	70.64	23.52	3.4
Ti K α	4510.8	8.40e+2	73.46	17.58	2.7
V K α	4952.2	6.66e+2	74.03	15.29	2.5
Cr K α	5414.7	5.32e+2	74.31	13.36	2.3
Mn K α	5898.8	4.29e+2	74.39	11.72	2.1
Co K α	6930.3	2.84e+2	74.17	9.14	1.8
Ni K α	7478.2	2.34e+2	73.93	8.12	1.7
Cu K α	8047.8	1.94e+2	73.62	7.24	1.5
Ge K α	9886.4	1.14e+2	72.06	5.22	1.3
Y K α	14988.0	1.53e+2	74.19	10.60	0.8
Mo K α	17479.0	1.04e+2	76.28	8.45	0.7
Pd K α	21177.0	6.36e+1	77.28	6.25	0.6
Sn K α	25271.0	3.98e+1	77.54	4.66	0.5
Xe K α	29779.0	2.55e+1	77.51	3.53	0.4

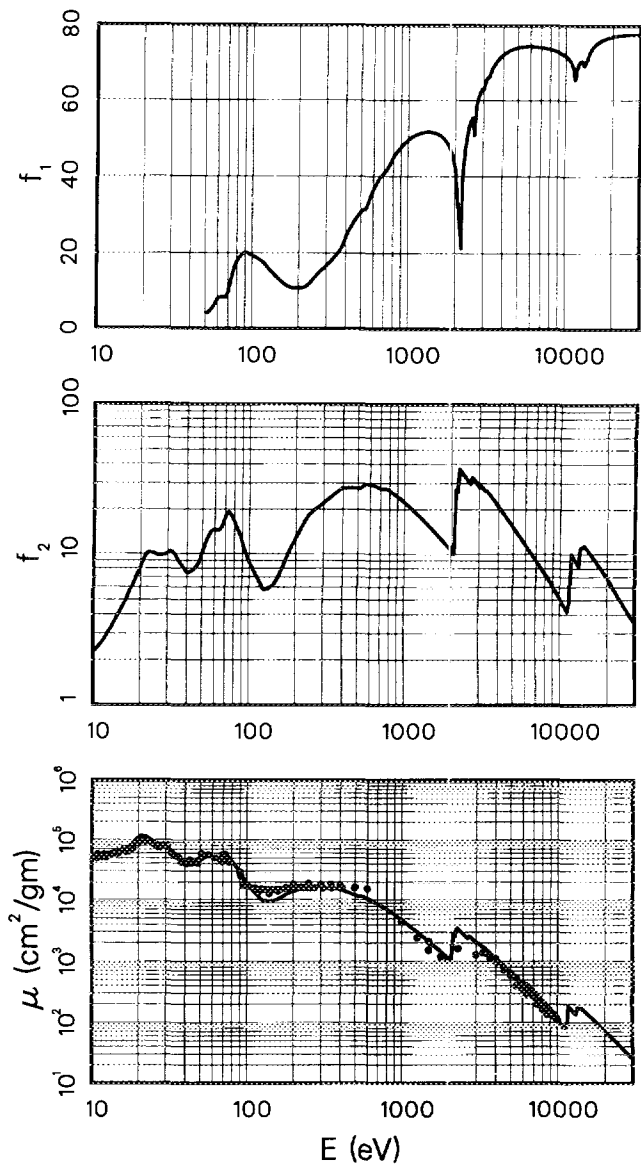

Edge Energies

L _I 13879.9 eV	M _I 3296.0 eV	N _I 725.4 eV ^b	O _I 101.7 eV ^a
L _{II} 13272.6 eV	M _{II} 3026.5 eV	N _{II} 609.1 eV ^b	O _{II} 65.3 eV ^a
L _{III} 11563.7 eV	M _{III} 2645.4 eV	N _{III} 519.4 eV ^b	O _{III} 51.7 eV ^b
	M _{IV} 2201.9 eV	N _{IV} 331.3 eV ^b	
	M _V 2121.6 eV	N _V 314.3 eV ^b	
		N _{VI} 74.5 eV ^b	
		N _{VII} 71.2 eV ^b	

References: 1, 2, 4, 5, 7, 48, 52, 123, 125, 136, 223, 229, 232.

TABLE I. Photoabsorption Cross Sections and Atomic Scattering Factors.

$Z = 1-92, E = 50-30,000 \text{ eV}$

See page 211 for Explanation of Tables

Gold (Au)

$Z = 79$

Atomic Weight = 196.967

$$\mu_a(\text{barns/atom}) = \mu(\text{cm}^2/\text{gm}) \times 327.08$$

$$E(\text{keV})\mu(\text{cm}^2/\text{gm}) = f_2 \times 213.63$$

Line	E(eV)	$\mu(\text{cm}^2/\text{gm})$	f_1	f_2	$\lambda(\text{\AA})$
H	10.2	3.84e+4		1.83	1215
He I	21.2	9.38e+4		9.32	584.3
Na L _{2,3}	30.5	7.81e+4		11.14	407.2
Mg L _{2,3}	49.3	5.32e+4		12.28	251.5
Al L _{2,3}	72.4	4.22e+4	17.14	14.30	171.2
Si L _{2,3}	91.5	2.61e+4	19.99	11.19	135.5
Be K	108.5	1.62e+4	20.25	8.22	114.3
Sr M ζ	114.0	1.42e+4	20.29	7.56	108.8
Y M ζ	132.8	9.23e+3	18.44	5.73	93.4
Zr M ζ	151.1	7.79e+3	16.23	5.51	82.1
B K α	183.3	1.06e+4	13.04	9.07	67.6
Mo M ζ	192.6	1.15e+4	12.97	10.40	64.4
Ar L ℓ	220.1	1.31e+4	13.46	13.46	56.3
C K α	277.0	1.43e+4	15.88	18.58	44.8
Ag M ζ	311.7	1.44e+4	18.09	21.04	39.8
N K α	392.4	1.34e+4	23.18	24.57	31.6
Ti L α	452.2	1.24e+4	26.65	26.29	27.4
V L α	511.3	1.15e+4	30.24	27.47	24.2
O K α	524.9	1.12e+4	31.06	27.60	23.6
Cr L α	572.8	1.04e+4	33.56	27.86	21.6
Mn L α	637.4	9.45e+3	36.69	28.20	19.5
F K α	676.8	8.88e+3	38.75	28.15	18.3
Fe L α	705.0	8.46e+3	40.02	27.92	17.6
Co L α	776.2	7.48e+3	43.06	27.19	16.0
Ni L α	851.5	6.52e+3	45.53	26.00	14.6
Cu L α	929.7	5.70e+3	47.68	24.80	13.3
Zn L α	1011.7	4.92e+3	49.59	23.32	12.3
Na K α	1041.0	4.68e+3	50.19	22.80	11.9
Ge L α	1188.0	3.57e+3	51.96	19.86	10.4
Mg K α	1253.6	3.20e+3	52.34	18.80	9.9
Al K α	1486.7	2.25e+3	52.60	15.68	8.3
Si K α	1740.0	1.61e+3	51.15	13.15	7.1
Zr L α	2042.4	1.14e+3	45.01	10.87	6.1
Mo L α	2293.2	3.09e+3	35.89	33.16	5.4
Cl K α	2622.4	2.56e+3	55.52	31.42	4.7
Ag L α	2984.3	2.17e+3	62.89	30.25	4.2
Ca K α	3691.7	1.44e+3	70.56	24.85	3.4
Ti K α	4510.8	8.83e+2	74.08	18.65	2.7
V K α	4952.2	7.00e+2	74.82	16.23	2.5
Cr K α	5414.7	5.59e+2	75.21	14.18	2.3
Mn K α	5898.8	4.50e+2	75.37	12.43	2.1
Co K α	6930.3	2.98e+2	75.24	9.68	1.8
Ni K α	7478.2	2.46e+2	75.03	8.60	1.7
Cu K α	8047.8	2.03e+2	74.74	7.66	1.5
Ge K α	9886.4	1.20e+2	73.32	5.55	1.3
Y K α	14988.0	1.60e+2	74.39	11.23	0.8
Mo K α	17479.0	1.09e+2	77.07	8.89	0.7
Pd K α	21177.0	6.59e+1	78.21	6.53	0.6
Sn K α	25271.0	4.12e+1	78.51	4.87	0.5
Xe K α	29779.0	2.65e+1	78.53	3.69	0.4

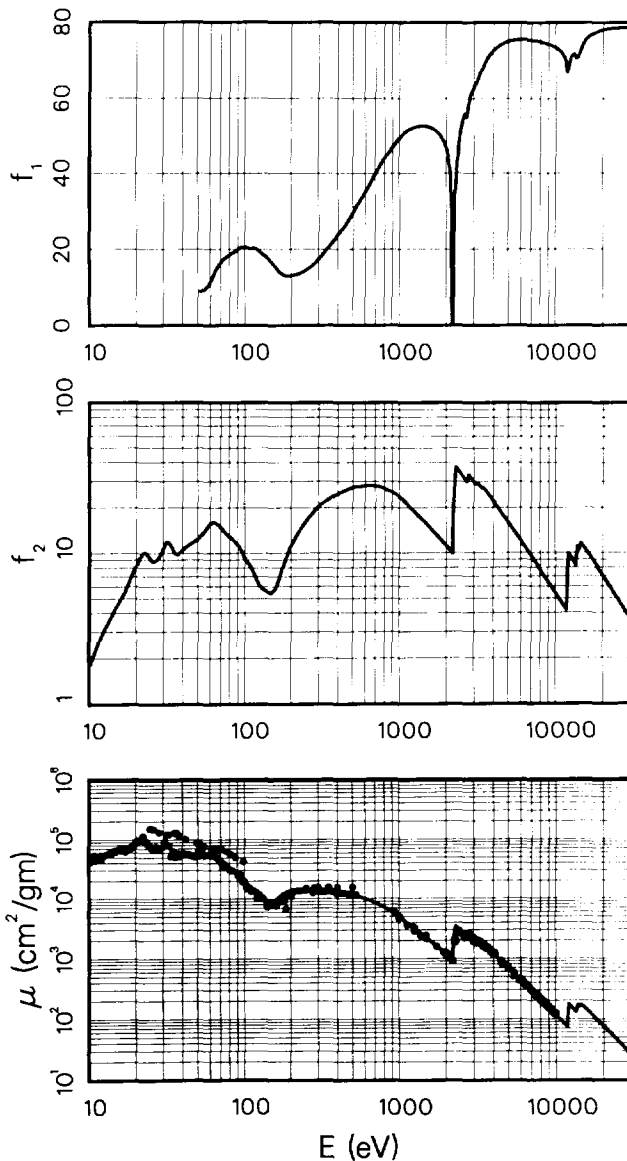

Edge Energies

L _I	14352.8 eV	M _I	3424.9 eV	N _I	762.1 eV ^b	O _I	107.2 eV ^b
L _{II}	13733.6 eV	M _{II}	3147.8 eV	N _{II}	642.7 eV ^b	O _{II}	74.2 eV ^b
L _{III}	11918.7 eV	M _{III}	2743.0 eV	N _{III}	546.3 eV ^b	O _{III}	57.2 eV ^b
		M _{IV}	2291.1 eV	N _{IV}	353.2 eV ^b		
		M _V	2205.7 eV	N _V	335.1 eV ^b		
				N _{VI}	87.6 eV ^b		
				N _{VII}	83.9 eV ^b		

References: 2, 4, 7, 11, 25, 28, 31, 48, 79, 95, 99, 100, 107, 108, 110, 122, 123, 126, 136, 149, 175, 177, 185, 188, 200, 206, 223, 229, 232.

TABLE I. Photoabsorption Cross Sections and Atomic Scattering Factors,
 $Z = 1-92$, $E = 50-30,000$ eV
 See page 211 for Explanation of Tables

Mercury (Hg)
 $Z = 80$

Atomic Weight = 200.590

$\mu_a(\text{barns/atom}) = \mu(\text{cm}^2/\text{gm}) \times 333.09$
 $E(\text{keV})\mu(\text{cm}^2/\text{gm}) = f_2 \times 209.77$

Line	E(eV)	$\mu(\text{cm}^2/\text{gm})$	f_1	f_2	$\lambda(\text{\AA})$
H	10.2	6.29e + 4		3.06	1215
He I	21.2	6.57e + 4		6.64	584.3
Na L _{2,3}	30.5	8.11e + 4		11.78	407.2
Mg L _{2,3}	49.3	8.10e + 4		19.04	251.5
Al L _{2,3}	72.4	5.23e + 4	16.07	18.04	171.2
Si L _{2,3}	91.5	3.09e + 4	19.84	13.48	135.5
Be K	108.5	1.95e + 4	20.73	10.08	114.3
Sr M ζ	114.0	1.64e + 4	20.84	8.92	108.8
Y M ζ	132.8	9.66e + 3	19.08	6.11	93.4
Zr M ζ	151.1	6.75e + 3	16.70	4.86	82.1
B K α	183.3	7.39e + 3	12.21	6.46	67.6
Mo M ζ	192.6	8.10e + 3	11.34	7.44	64.4
Ar L ℓ	220.1	1.05e + 4	9.59	11.06	56.3
C K α	277.0	1.43e + 4	9.99	18.93	44.8
Ag M ζ	311.7	1.58e + 4	12.25	23.46	39.8
N K α	392.4	1.57e + 4	20.16	29.41	31.6
Ti L α	452.2	1.43e + 4	25.83	30.82	27.4
V L α	511.3	1.27e + 4	30.10	31.07	24.2
O K α	524.9	1.24e + 4	31.04	31.05	23.6
Cr L α	572.8	1.12e + 4	33.36	30.56	21.6
Mn L α	637.4	1.04e + 4	36.60	31.63	19.5
F K α	676.8	9.76e + 3	39.13	31.49	18.3
Fe L α	705.0	9.26e + 3	40.82	31.12	17.6
Co L α	776.2	7.95e + 3	43.72	29.42	16.0
Ni L α	851.5	7.14e + 3	46.50	28.97	14.6
Cu L α	929.7	6.10e + 3	49.34	27.04	13.3
Zn L α	1011.7	5.21e + 3	51.25	25.12	12.3
Na K α	1041.0	4.92e + 3	51.81	24.41	11.9
Ge L α	1188.0	3.76e + 3	53.50	21.30	10.4
Mg K α	1253.6	3.37e + 3	53.91	20.14	9.9
Al K α	1486.7	2.38e + 3	54.39	16.84	8.3
Si K α	1740.0	1.70e + 3	53.43	14.09	7.1
Zr L α	2042.4	1.19e + 3	49.22	11.61	6.1
Mo L α	2293.2	1.77e + 3	34.02	19.31	5.4
Cl K α	2622.4	2.63e + 3	54.39	32.86	4.7
Ag L α	2984.3	2.24e + 3	61.87	31.88	4.2
Ca K α	3691.7	1.48e + 3	70.45	26.08	3.4
Ti K α	4510.8	9.13e + 2	74.76	19.64	2.7
V K α	4952.2	7.24e + 2	75.66	17.10	2.5
Cr K α	5414.7	5.79e + 2	76.17	14.94	2.3
Mn K α	5898.8	4.66e + 2	76.38	13.10	2.1
Co K α	6930.3	3.09e + 2	76.35	10.20	1.8
Ni K α	7478.2	2.54e + 2	76.20	9.05	1.7
Cu K α	8047.8	2.10e + 2	75.95	8.06	1.5
Ge K α	9886.4	1.24e + 2	74.72	5.83	1.3
Y K α	14988.0	1.63e + 2	73.80	11.66	0.8
Mo K α	17479.0	1.12e + 2	77.64	9.30	0.7
Pd K α	21177.0	6.81e + 1	79.04	6.88	0.6
Sn K α	25271.0	4.27e + 1	79.44	5.15	0.5
Xe K α	29779.0	2.75e + 1	79.47	3.90	0.4

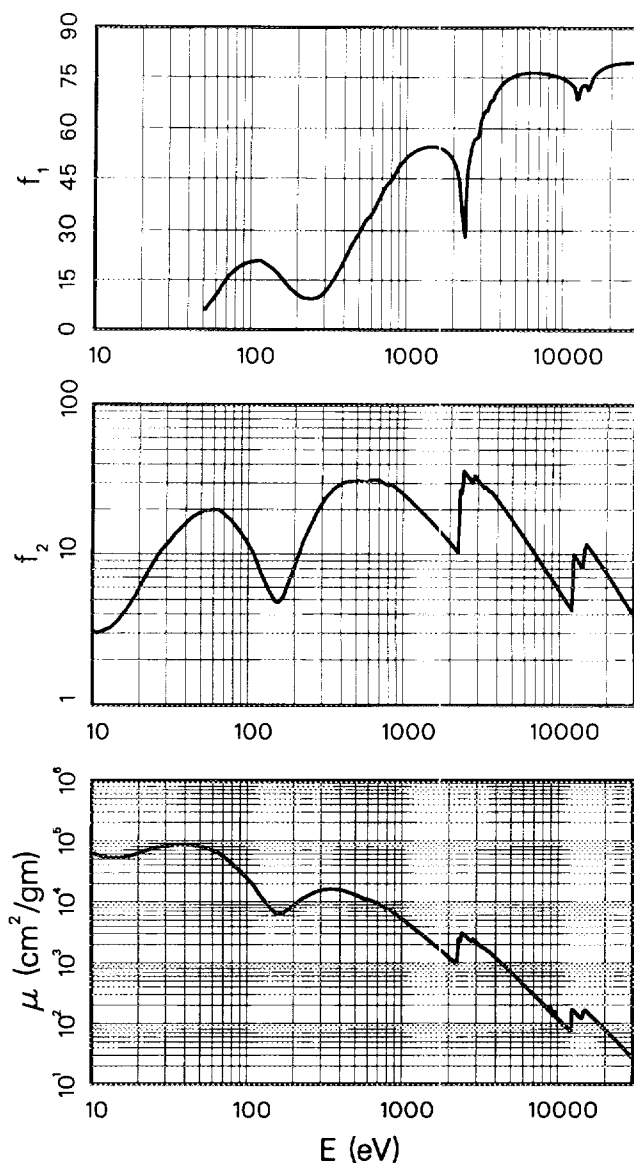

Edge Energies

L _I	14839.3 eV	M _I	3561.6 eV	N _I	802.2 eV ^b	O _I	127. eV ^b
L _{II}	14208.7 eV	M _{II}	3278.5 eV	N _{II}	680.2 eV ^b	O _{II}	83.1 eV ^b
L _{III}	12283.9 eV	M _{III}	2847.1 eV	N _{III}	576.6 eV ^b	O _{III}	64.5 eV ^b
		M _{IV}	2384.9 eV	N _{IV}	378.2 eV ^b		
		M _V	2294.9 eV	N _V	358.8 eV ^b		
				N _{VI}	104.0 eV ^b		
				N _{VII}	99.9 eV ^b		

References: 14.

TABLE I. Photoabsorption Cross Sections and Atomic Scattering Factors,
 $Z = 1-92$, $E = 50-30,000$ eV
 See page 211 for Explanation of Tables

$\mu_a(\text{barns/atom}) = \mu(\text{cm}^2/\text{gm}) \times 339.39$
 $E(\text{keV})\mu(\text{cm}^2/\text{gm}) = f_2 \times 205.88$

Thallium (Tl)
 $Z = 81$
 Atomic Weight = 204.383

Line	E(eV)	$\mu(\text{cm}^2/\text{gm})$	f_1	f_2	$\lambda(\text{\AA})$
H	10.2	3.51e+4		1.74	1215
He I	21.2	4.18e+4		4.31	584.3
Na L _{2,3}	30.5	6.55e+4		9.68	407.2
Mg L _{2,3}	49.3	8.35e+4		20.00	251.5
Al L _{2,3}	72.4	5.74e+4	17.26	20.20	171.2
Si L _{2,3}	91.5	3.34e+4	21.91	14.85	135.5
Be K	108.5	2.04e+4	23.11	10.74	114.3
Sr M ζ	114.0	1.73e+4	23.11	9.56	108.8
Y M ζ	132.8	1.03e+4	21.42	6.63	93.4
Zr M ζ	151.1	6.99e+3	19.61	5.13	82.1
B K α	183.3	5.98e+3	15.00	5.32	67.6
Mo M ζ	192.6	6.67e+3	13.93	6.24	64.4
Ar L l	220.1	8.68e+3	11.89	9.28	56.3
C K α	277.0	1.26e+4	11.44	16.94	44.8
Ag M ζ	311.7	1.39e+4	13.06	21.06	39.8
N K α	392.4	1.45e+4	19.44	27.68	31.6
Ti L α	452.2	1.37e+4	24.88	30.04	27.4
V L α	511.3	1.25e+4	29.39	30.93	24.2
O K α	524.9	1.22e+4	30.43	31.03	23.6
Cr L α	572.8	1.10e+4	33.56	30.67	21.6
Mn L α	637.4	9.71e+3	35.65	30.06	19.5
F K α	676.8	9.64e+3	37.32	31.70	18.3
Fe L α	705.0	9.29e+3	39.60	31.81	17.6
Co L α	776.2	8.03e+3	43.08	30.26	16.0
Ni L α	851.5	7.26e+3	46.09	30.04	14.6
Cu L α	929.7	6.27e+3	49.16	28.33	13.3
Zn L α	1011.7	5.44e+3	51.51	26.71	12.3
Na K α	1041.0	5.14e+3	52.29	25.98	11.9
Ge L α	1188.0	3.92e+3	54.50	22.60	10.4
Mg K α	1253.6	3.51e+3	55.05	21.35	9.9
Al K α	1486.7	2.46e+3	55.90	17.79	8.3
Si K α	1740.0	1.76e+3	55.39	14.91	7.1
Zr L α	2042.4	1.24e+3	52.46	12.27	6.1
Mo L α	2293.2	9.48e+2	44.33	10.56	5.4
Cl K α	2622.4	2.71e+3	51.72	34.56	4.7
Ag L α	2984.3	2.14e+3	56.98	30.98	4.2
Ca K α	3691.7	1.48e+3	70.11	26.46	3.4
Ti K α	4510.8	9.32e+2	75.25	20.43	2.7
V K α	4952.2	7.41e+2	76.32	17.83	2.5
Cr K α	5414.7	5.93e+2	76.96	15.60	2.3
Mn K α	5898.8	4.78e+2	77.27	13.70	2.1
Co K α	6930.3	3.17e+2	77.37	10.67	1.8
Ni K α	7478.2	2.61e+2	77.26	9.48	1.7
Cu K α	8047.8	2.16e+2	77.05	8.45	1.5
Ge K α	9886.4	1.27e+2	75.97	6.11	1.3
Y K α	14988.0	1.47e+2	73.36	10.67	0.8
Mo K α	17479.0	1.14e+2	78.19	9.70	0.7
Pd K α	21177.0	6.96e+1	79.87	7.16	0.6
Sn K α	25271.0	4.37e+1	80.35	5.36	0.5
Xe K α	29779.0	2.82e+1	80.42	4.08	0.4

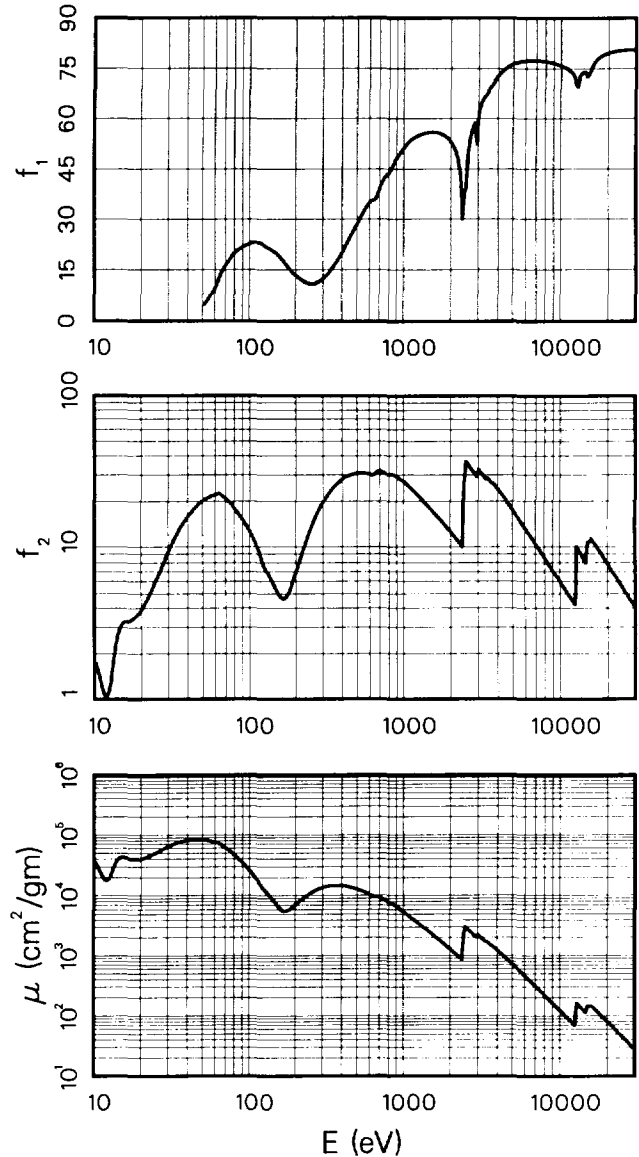

Edge Energies

L _I	15346.7 eV	M _I	3704.1 eV	N _I	846.2 eV ^b	O _I	136. eV ^a
L _{II}	14697.9 eV	M _{II}	3415.7 eV	N _{II}	720.5 eV ^b	O _{II}	94.6 eV ^b
L _{III}	12657.5 eV	M _{III}	2956.6 eV	N _{III}	609.5 eV ^b	O _{III}	73.5 eV ^b
		M _{IV}	2485.1 eV	N _{IV}	405.7 eV ^b	O _{IV}	14.7 eV ^b
		M _V	2389.3 eV	N _V	385.0 eV ^b	O _V	12.5 eV ^b
				N _{VI}	122.2 eV ^b		
				N _{VII}	117.8 eV ^b		

TABLE I. Photoabsorption Cross Sections and Atomic Scattering Factors,
 $Z = 1-92$, $E = 50-30,000$ eV
 See page 211 for Explanation of Tables

$\mu_a(\text{barns/atom}) = \mu(\text{cm}^2/\text{gm}) \times 344.07$
 $E(\text{keV})\mu(\text{cm}^2/\text{gm}) = f_2 \times 203.08$

Lead (Pb)
 $Z = 82$
 Atomic Weight = 207.200

Line	E(eV)	$\mu(\text{cm}^2/\text{gm})$	f_1	f_2	$\lambda(\text{\AA})$
H	10.2	9.44e + 4		4.74	1215
He I	21.2	4.74e + 4		4.95	584.3
Na L _{2,3}	30.5	4.11e + 4		6.16	407.2
Mg L _{2,3}	49.3	7.38e + 4		17.91	251.5
Al L _{2,3}	72.4	6.24e + 4	15.64	22.24	171.2
Si L _{2,3}	91.5	4.07e + 4	23.96	18.34	135.5
Be K	108.5	2.30e + 4	26.76	12.28	114.3
Sr M ζ	114.0	1.81e + 4	26.67	10.15	108.8
Y M ζ	132.8	1.04e + 4	24.13	6.79	93.4
Zr M ζ	151.1	7.16e + 3	22.63	5.33	82.1
B K α	183.3	4.76e + 3	18.75	4.30	67.6
Mo M ζ	192.6	4.73e + 3	17.62	4.49	64.4
Ar L ℓ	220.1	6.00e + 3	14.30	6.51	56.3
C K α	277.0	1.04e + 4	11.87	14.18	44.8
Ag M ζ	311.7	1.24e + 4	13.00	19.10	39.8
N K α	392.4	1.39e + 4	19.42	26.81	31.6
Ti L α	452.2	1.31e + 4	24.31	29.18	27.4
V L α	511.3	1.21e + 4	29.20	30.40	24.2
O K α	524.9	1.18e + 4	30.13	30.46	23.6
Cr L α	572.8	1.08e + 4	33.04	30.52	21.6
Mn L α	637.4	9.70e + 3	36.24	30.46	19.5
F K α	676.8	9.17e + 3	37.91	30.55	18.3
Fe L α	705.0	8.83e + 3	39.15	30.65	17.6
Co L α	776.2	8.01e + 3	42.47	30.60	16.0
Ni L α	851.5	7.12e + 3	45.55	29.87	14.6
Cu L α	929.7	6.41e + 3	48.62	29.34	13.3
Zn L α	1011.7	5.52e + 3	51.60	27.52	12.3
Na K α	1041.0	5.22e + 3	52.39	26.78	11.9
Ge L α	1188.0	4.01e + 3	54.86	23.46	10.4
Mg K α	1253.6	3.60e + 3	55.52	22.22	9.9
Al K α	1486.7	2.56e + 3	56.80	18.73	8.3
Si K α	1740.0	1.83e + 3	56.77	15.71	7.1
Zr L α	2042.4	1.29e + 3	54.70	12.98	6.1
Mo L α	2293.2	9.94e + 2	49.82	11.23	5.4
Cl K α	2622.4	2.50e + 3	43.96	32.32	4.7
Ag L α	2984.3	2.06e + 3	59.20	30.24	4.2
Ca K α	3691.7	1.51e + 3	70.08	27.36	3.4
Ti K α	4510.8	9.66e + 2	75.78	21.45	2.7
V K α	4952.2	7.67e + 2	77.02	18.70	2.5
Cr K α	5414.7	6.14e + 2	77.76	16.37	2.3
Mn K α	5898.8	4.95e + 2	78.15	14.39	2.1
Co K α	6930.3	3.30e + 2	78.36	11.25	1.8
Ni K α	7478.2	2.72e + 2	78.29	10.01	1.7
Cu K α	8047.8	2.25e + 2	78.13	8.94	1.5
Ge K α	9886.4	1.33e + 2	77.23	6.48	1.3
Y K α	14988.0	1.09e + 2	73.90	8.01	0.8
Mo K α	17479.0	1.18e + 2	78.63	10.12	0.7
Pd K α	21177.0	7.19e + 1	80.67	7.50	0.6
Sn K α	25271.0	4.52e + 1	81.26	5.62	0.5
Xe K α	29779.0	2.92e + 1	81.38	4.28	0.4

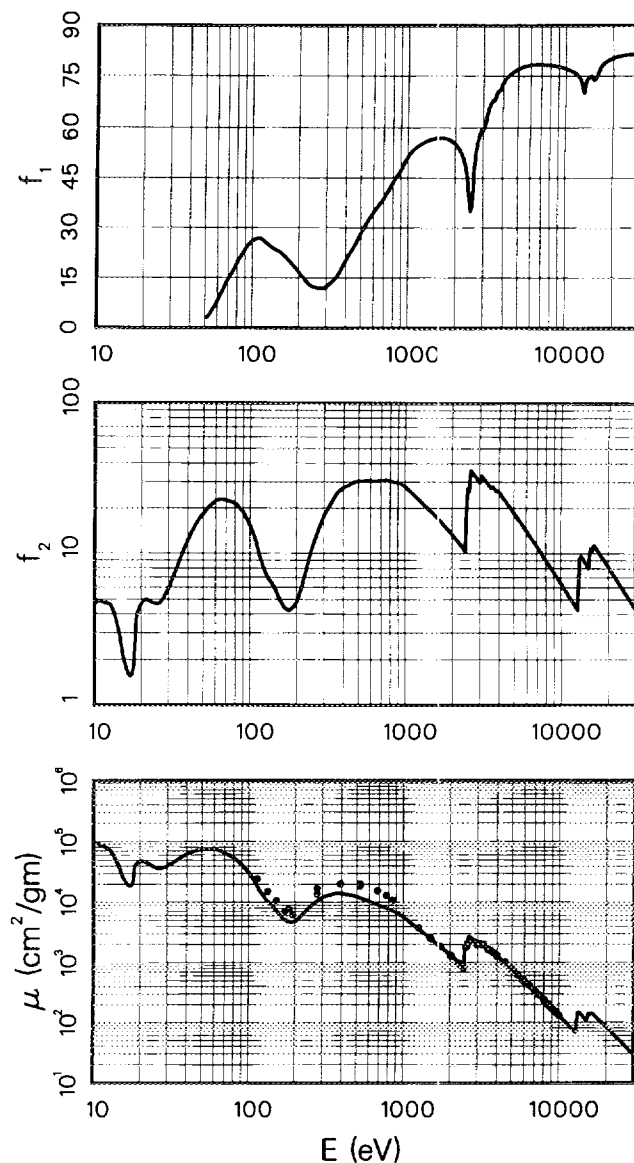

Edge Energies

L _I 15860.8 eV	M _I 3850.7 eV	N _I 891.8 eV ^b	O _I 147. eV ^a
L _{II} 15200.0 eV	M _{II} 3554.2 eV	N _{II} 761.9 eV ^b	O _{II} 106.4 eV ^b
L _{III} 13035.2 eV	M _{III} 3066.4 eV	N _{III} 643.5 eV ^b	O _{III} 83.3 eV ^b
	M _{IV} 2585.6 eV	N _{IV} 434.3 eV ^b	O _{IV} 20.7 eV ^b
	M _V 2484.0 eV	N _V 412.2 eV ^b	O _V 18.1 eV ^b
		N _{VI} 141.7 eV ^b	
		N _{VII} 136.9 eV ^b	

References: 4, 16, 25, 99, 102, 131, 152, 169, 177, 188, 229.

TABLE I. Photoabsorption Cross Sections and Atomic Scattering Factors.
 $Z = 1-92$, $E = 50-30,000$ eV
 See page 211 for Explanation of Tables

Bismuth (Bi)
 $Z = 83$
 Atomic Weight = 208.980

$\mu_a(\text{barns/atom}) = \mu(\text{cm}^2/\text{gm}) \times 347.03$
 $E(\text{keV})\mu(\text{cm}^2/\text{gm}) = f_2 \times 201.35$

Line	E(eV)	$\mu(\text{cm}^2/\text{gm})$	f_1	f_2	$\lambda(\text{\AA})$
H	10.2	1.11e+5		5.65	1215
He I	21.2	1.68e+4		1.77	584.3
Na L _{2,3}	30.5	3.40e+4		5.14	407.2
Mg L _{2,3}	49.3	6.87e+4		16.83	251.5
Al L _{2,3}	72.4	7.95e+4	11.05	28.58	171.2
Si L _{2,3}	91.5	5.33e+4	24.00	24.21	135.5
Be K	108.5	3.01e+4	29.17	16.20	114.3
Sr M ζ	114.0	2.42e+4	29.36	13.71	108.8
Y M ζ	132.8	1.20e+4	27.25	7.91	93.4
Zr M ζ	151.1	7.99e+3	24.88	5.99	82.1
B K α	183.3	4.58e+3	20.52	4.17	67.6
Mo M ζ	192.6	4.50e+3	19.28	4.31	64.4
Ar L ℓ	220.1	5.37e+3	15.92	5.87	56.3
C K α	277.0	9.28e+3	12.64	12.77	44.8
Ag M ζ	311.7	1.14e+4	13.03	17.58	39.8
N K α	392.4	1.29e+4	17.88	25.05	31.6
Ti L α	452.2	1.30e+4	21.90	29.13	27.4
V L α	511.3	1.26e+4	26.84	31.93	24.2
O K α	524.9	1.24e+4	28.04	32.36	23.6
Cr L α	572.8	1.15e+4	32.50	32.82	21.6
Mn L α	637.4	1.01e+4	36.64	32.01	19.5
F K α	676.8	9.32e+3	38.39	31.34	18.3
Fe L α	705.0	8.88e+3	39.01	31.08	17.6
Co L α	776.2	8.48e+3	42.22	32.71	16.0
Ni L α	851.5	7.38e+3	46.45	31.20	14.6
Cu L α	929.7	6.40e+3	48.88	29.54	13.3
Zn L α	1011.7	5.75e+3	51.41	28.90	12.3
Na K α	1041.0	5.46e+3	52.51	28.24	11.9
Ge L α	1188.0	4.22e+3	55.49	24.89	10.4
Mg K α	1253.6	3.80e+3	56.30	23.64	9.9
Al K α	1486.7	2.71e+3	58.03	20.03	8.3
Si K α	1740.0	1.95e+3	58.44	16.85	7.1
Zr L α	2042.4	1.37e+3	57.09	13.91	6.1
Mo L α	2293.2	1.05e+3	53.80	11.98	5.4
Cl K α	2622.4	1.49e+3	37.89	19.38	4.7
Ag L α	2984.3	2.13e+3	59.59	31.63	4.2
Ca K α	3691.7	1.51e+3	69.86	27.61	3.4
Ti K α	4510.8	9.94e+2	76.13	22.26	2.7
V K α	4952.2	7.92e+2	77.61	19.47	2.5
Cr K α	5414.7	6.35e+2	78.52	17.08	2.3
Mn K α	5898.8	5.13e+2	79.02	15.02	2.1
Co K α	6930.3	3.41e+2	79.37	11.73	1.8
Ni K α	7478.2	2.81e+2	79.34	10.43	1.7
Cu K α	8047.8	2.33e+2	79.22	9.30	1.5
Ge K α	9886.4	1.37e+2	78.41	6.73	1.3
Y K α	14988.0	1.13e+2	75.94	8.38	0.8
Mo K α	17479.0	1.21e+2	78.89	10.50	0.7
Pd K α	21177.0	7.47e+1	81.39	7.85	0.6
Sn K α	25271.0	4.72e+1	82.14	5.92	0.5
Xe K α	29779.0	3.05e+1	82.34	4.52	0.4

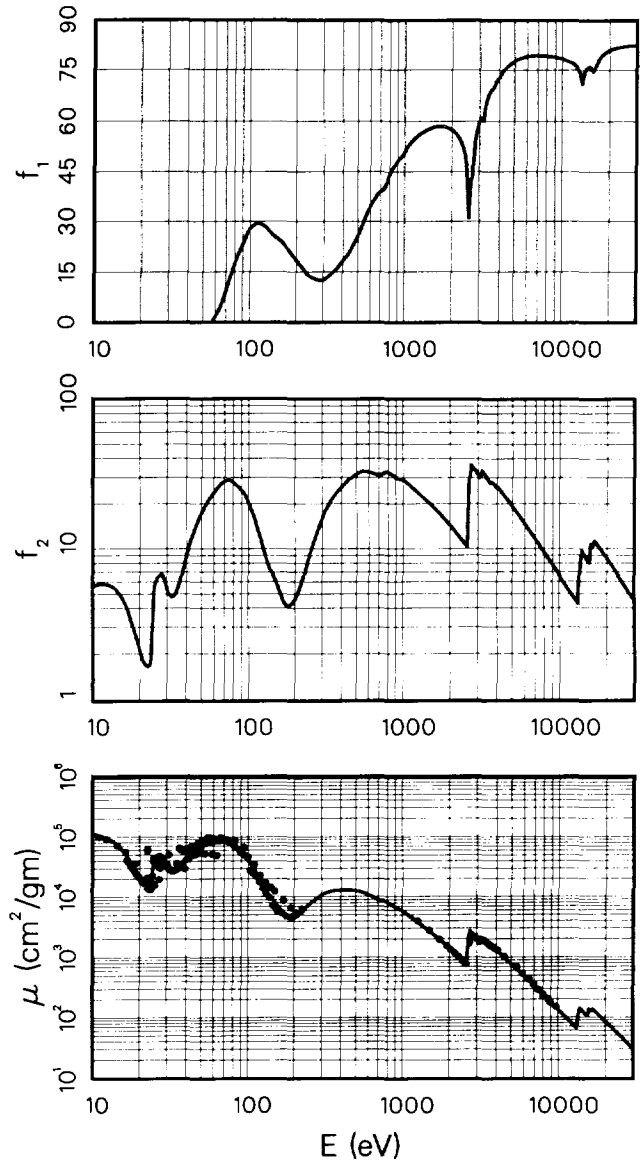

Edge Energies

L _I 16387.5 eV	M _I 3999.1 eV	N _I 939. eV ^b	O _I 159.3 eV ^a
L _{II} 15711.1 eV	M _{II} 3696.3 eV	N _{II} 805.2 eV ^b	O _{II} 119.0 eV ^b
L _{III} 13418.6 eV	M _{III} 3176.9 eV	N _{III} 678.8 eV ^b	O _{III} 92.6 eV ^b
	M _{IV} 2687.6 eV	N _{IV} 464.0 eV ^b	O _{IV} 26.9 eV ^b
	M _V 2579.6 eV	N _V 440.1 eV ^b	O _V 23.8 eV ^b
		N _{VI} 162.3 eV ^b	
		N _{VII} 157.0 eV ^b	

References: 20, 25, 99, 110, 122, 145, 185.

TABLE I. Photoabsorption Cross Sections and Atomic Scattering Factors,
 $Z = 1-92$, $E = 50-30,000$ eV
 See page 211 for Explanation of Tables

Polonium (Po)
 $Z = 84$

Atomic Weight = 209.980

$\mu_a(\text{barns/atom}) = \mu(\text{cm}^2/\text{gm}) \times 348.69$
 $E(\text{keV})\mu(\text{cm}^2/\text{gm}) = f_2 \times 200.39$

Line	E(eV)	$\mu(\text{cm}^2/\text{gm})$	f_1	f_2	$\lambda(\text{\AA})$
H	10.2	9.71e + 4		4.94	1215
He I	21.2	3.32e + 4		3.52	584.3
Na L _{2,3}	30.5	1.38e + 4		2.10	407.2
Mg L _{2,3}	49.3	5.56e + 4		13.68	251.5
Al L _{2,3}	72.4	7.28e + 4	8.63	26.32	171.2
Si L _{2,3}	91.5	5.56e + 4	22.16	25.41	135.5
Be K	108.5	3.27e + 4	27.21	17.70	114.3
Sr M ζ	114.0	2.78e + 4	27.94	15.82	108.8
Y M ζ	132.8	1.63e + 4	26.67	10.82	93.4
Zr M ζ	151.1	1.04e + 4	26.46	7.82	82.1
B K α	183.3	4.88e + 3	22.57	4.46	67.6
Mo M ζ	192.6	4.35e + 3	21.54	4.18	64.4
Ar L ℓ	220.1	3.64e + 3	17.91	3.99	56.3
C K α	277.0	6.90e + 3	11.27	9.54	44.8
Ag M ζ	311.7	9.74e + 3	10.30	15.15	39.8
N K α	392.4	1.31e + 4	13.33	25.73	31.6
Ti L α	452.2	1.44e + 4	18.20	32.52	27.4
V L α	511.3	1.42e + 4	26.18	36.20	24.2
O K α	524.9	1.39e + 4	27.91	36.51	23.6
Cr L α	572.8	1.27e + 4	33.36	36.20	21.6
Mn L α	637.4	1.06e + 4	38.00	33.74	19.5
F K α	676.8	9.71e + 3	39.21	32.80	18.3
Fe L α	705.0	9.28e + 3	39.70	32.63	17.6
Co L α	776.2	8.86e + 3	43.00	34.34	16.0
Ni L α	851.5	7.70e + 3	47.37	32.72	14.6
Cu L α	929.7	6.68e + 3	49.87	30.98	13.3
Zn L α	1011.7	6.01e + 3	52.52	30.34	12.3
Na K α	1041.0	5.71e + 3	53.70	29.66	11.9
Ge L α	1188.0	4.40e + 3	56.90	26.10	10.4
Mg K α	1253.6	3.96e + 3	57.77	24.76	9.9
Al K α	1486.7	2.82e + 3	59.67	20.92	8.3
Si K α	1740.0	2.03e + 3	60.29	17.60	7.1
Zr L α	2042.4	1.43e + 3	59.41	14.55	6.1
Mo L α	2293.2	1.10e + 3	57.09	12.55	5.4
Cl K α	2622.4	7.98e + 2	45.12	10.45	4.7
Ag L α	2984.3	2.21e + 3	57.80	32.98	4.2
Ca K α	3691.7	1.51e + 3	70.31	27.88	3.4
Ti K α	4510.8	1.02e + 3	76.52	23.03	2.7
V K α	4952.2	8.15e + 2	78.24	20.13	2.5
Cr K α	5414.7	6.53e + 2	79.28	17.66	2.3
Mn K α	5898.8	5.28e + 2	79.87	15.54	2.1
Co K α	6930.3	3.52e + 2	80.34	12.16	1.8
Ni K α	7478.2	2.90e + 2	80.36	10.82	1.7
Cu K α	8047.8	2.40e + 2	80.28	9.66	1.5
Ge K α	9886.4	1.41e + 2	79.70	6.98	1.3
Y K α	14988.0	1.17e + 2	76.81	8.76	0.8
Mo K α	17479.0	1.24e + 2	78.88	10.85	0.7
Pd K α	21177.0	7.75e + 1	82.11	8.19	0.6
Sn K α	25271.0	4.92e + 1	83.02	6.20	0.5
Xe K α	29779.0	3.19e + 1	83.29	4.74	0.4

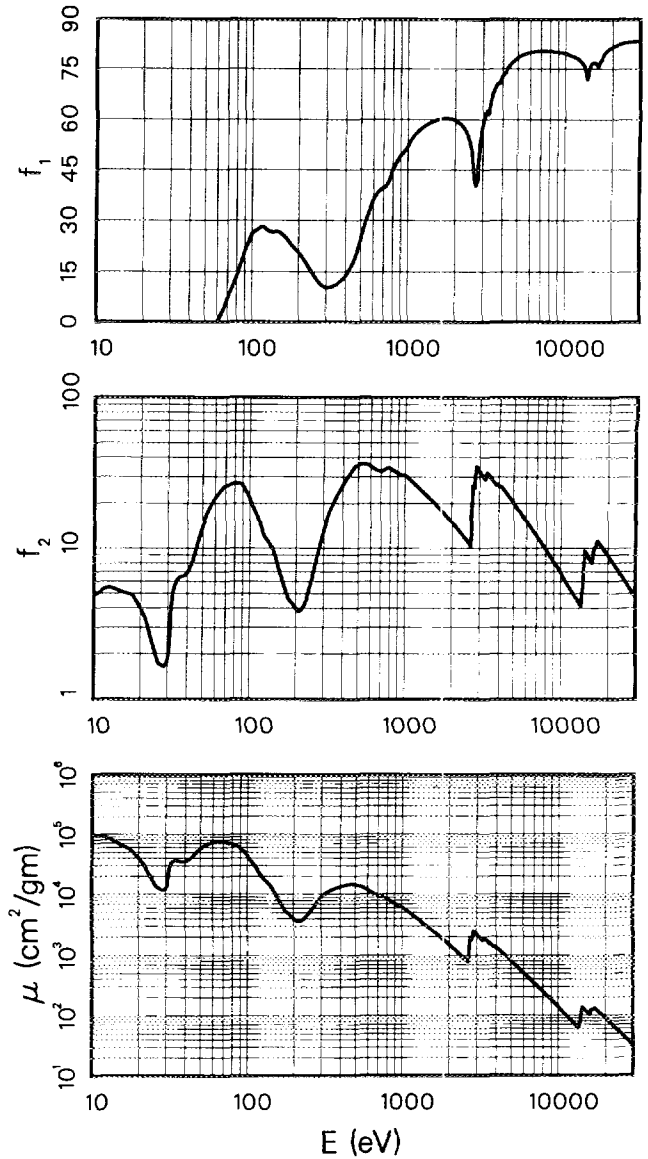

Edge Energies

L _I 16939.3 eV	M _I 4149.4 eV	N _I 995. eV ^a	O _I 177. eV ^a
L _{II} 16244.3 eV	M _{II} 3854.1 eV	N _{II} 851. eV ^a	O _{II} 132. eV ^a
L _{III} 13813.8 eV	M _{III} 3301.9 eV	N _{III} 705. eV ^a	O _{III} 104. eV ^a
	M _{IV} 2798.0 eV	N _{IV} 500. eV ^a	O _{IV} 31. eV ^a
	M _V 2683.0 eV	N _V 473. eV ^a	O _V 31. eV ^a
		N _{VI} 184. eV ^a	
		N _{VII} 184. eV ^a	

TABLE I. Photoabsorption Cross Sections and Atomic Scattering Factors.

$Z = 1-92, E = 50-30,000 \text{ eV}$

See page 211 for Explanation of Tables

$\mu_a(\text{barns/atom}) = \mu(\text{cm}^2/\text{gm}) \times 348.70$
 $E(\text{keV})\mu(\text{cm}^2/\text{gm}) = f_2 \times 200.38$

Astatine (At)
 $Z = 85$
 Atomic Weight = 209.990

Line	E(eV)	$\mu(\text{cm}^2/\text{gm})$	f_1	f_2	$\lambda (\text{\AA})$
H	10.2	1.75e + 5		8.89	1215
He I	21.2	6.11e + 4		6.47	584.3
Na L _{2,3}	30.5	1.46e + 4		2.22	407.2
Mg L _{2,3}	49.3	2.84e + 4		6.99	251.5
Al L _{2,3}	72.4	8.19e + 4	2.81	29.58	171.2
Si L _{2,3}	91.5	6.65e + 4	21.70	30.35	135.5
Be K	108.5	4.04e + 4	29.56	21.88	114.3
Sr M ζ	114.0	3.30e + 4	30.85	18.80	108.8
Y M ζ	132.8	1.91e + 4	29.78	12.69	93.4
Zr M ζ	151.1	1.17e + 4	29.59	8.80	82.1
B K α	183.3	4.17e + 3	25.44	3.81	67.6
Mo M ζ	192.6	3.62e + 3	24.03	3.48	64.4
Ar L ζ	220.1	3.03e + 3	20.62	3.32	56.3
C K α	277.0	4.41e + 3	13.41	6.09	44.8
Ag M ζ	311.7	7.74e + 3	10.51	12.03	39.8
N K α	392.4	1.22e + 4	13.48	23.89	31.6
Ti L α	452.2	1.28e + 4	18.18	28.95	27.4
V L α	511.3	1.30e + 4	23.06	33.11	24.2
O K α	524.9	1.29e + 4	24.58	33.82	23.6
Cr L α	572.8	1.22e + 4	29.07	34.87	21.6
Mn L α	637.4	1.11e + 4	34.51	35.42	19.5
F K α	676.8	1.03e + 4	37.40	34.89	18.3
Fe L α	705.0	9.77e + 3	39.07	34.36	17.6
Co L α	776.2	8.48e + 3	41.47	32.87	16.0
Ni L α	851.5	8.11e + 3	44.81	34.46	14.6
Cu L α	929.7	7.07e + 3	49.22	32.80	13.3
Zn L α	1011.7	6.10e + 3	51.98	30.79	12.3
Na K α	1041.0	5.79e + 3	52.71	30.10	11.9
Ge L α	1188.0	4.65e + 3	55.71	27.54	10.4
Mg K α	1253.6	4.24e + 3	56.92	26.52	9.9
Al K α	1486.7	3.05e + 3	59.68	22.61	8.3
Si K α	1740.0	2.20e + 3	60.83	19.12	7.1
Zr L α	2042.4	1.56e + 3	60.49	15.86	6.1
Mo L α	2293.2	1.20e + 3	58.86	13.70	5.4
Cl K α	2622.4	8.73e + 2	52.44	11.42	4.7
Ag L α	2984.3	2.40e + 3	50.79	35.70	4.2
Ca K α	3691.7	1.63e + 3	69.81	30.11	3.4
Ti K α	4510.8	1.10e + 3	76.51	24.76	2.7
V K α	4952.2	8.79e + 2	78.72	21.72	2.5
Cr K α	5414.7	7.06e + 2	80.04	19.08	2.3
Mn K α	5898.8	5.71e + 2	80.81	16.80	2.1
Co K α	6930.3	3.80e + 2	81.50	13.13	1.8
Ni K α	7478.2	3.13e + 2	81.58	11.67	1.7
Cu K α	8047.8	2.59e + 2	81.55	10.40	1.5
Ge K α	9886.4	1.51e + 2	81.15	7.47	1.3
Y K α	14988.0	1.23e + 2	77.15	9.23	0.8
Mo K α	17479.0	1.27e + 2	78.46	11.07	0.7
Pd K α	21177.0	8.12e + 1	82.89	8.58	0.6
Sn K α	25271.0	5.14e + 1	83.93	6.48	0.5
X γ K α	29779.0	3.33e + 1	84.25	4.95	0.4

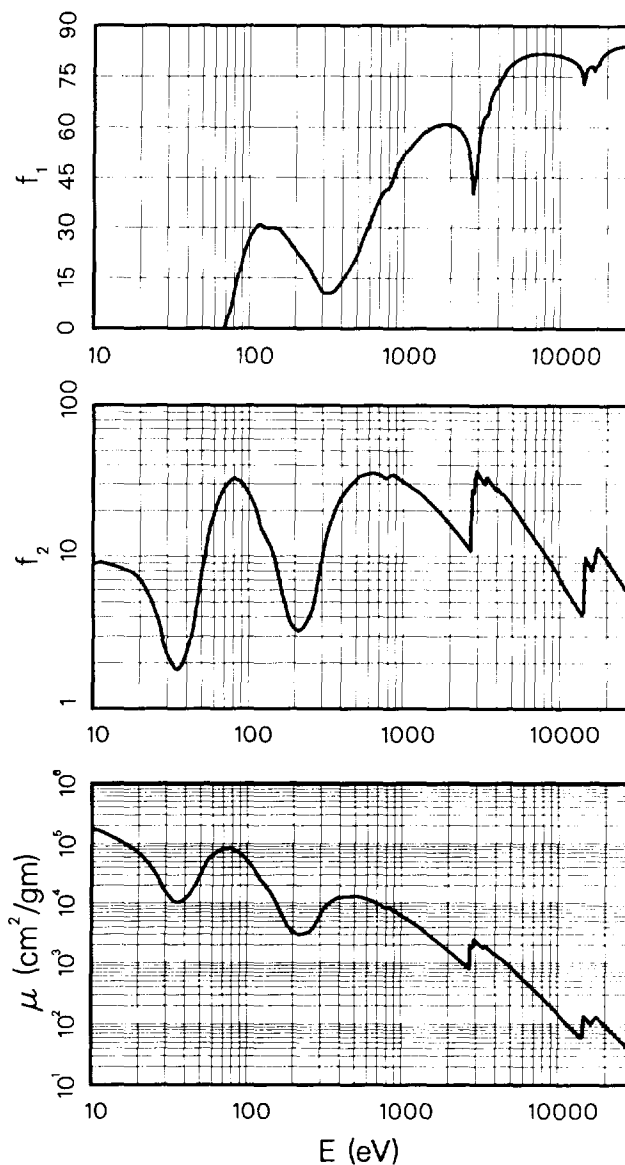

Edge Energies

L _I	17493. eV	M _I	4317. eV	N _I	1042. eV ^a	O _I	195. eV ^a
L _{II}	16784.7 eV	M _{II}	4008. eV	N _{II}	886. eV ^a	O _{II}	148. eV ^a
L _{III}	14213.5 eV	M _{III}	3426. eV	N _{III}	740. eV ^a	O _{III}	115. eV ^a
		M _{IV}	2908.7 eV	N _{IV}	533. eV ^a	O _{IV}	40. eV ^a
		M _V	2786.7 eV	N _V	507. eV ^a	O _V	40. eV ^a
				N _{VI}	210. eV ^a		
				N _{VII}	210. eV ^a		

TABLE I. Photoabsorption Cross Sections and Atomic Scattering Factors,
 $Z = 1-92, E = 50-30,000 \text{ eV}$

See page 211 for Explanation of Tables

Radon (Rn)

$Z = 86$

Atomic Weight = 222.020

$$\mu_a(\text{barns/atom}) = \mu(\text{cm}^2/\text{gm}) \times 368.68$$

$$E(\text{keV})\mu(\text{cm}^2/\text{gm}) = f_2 \times 189.52$$

Line	E(eV)	$\mu(\text{cm}^2/\text{gm})$	f_1	f_2	$\lambda(\text{\AA})$
H	10.2	6.15e+4		3.31	1215
He I	21.2	8.57e+4		9.59	584.3
Na L _{2,3}	30.5	2.90e+4		4.67	407.2
Mg L _{2,3}	49.3	7.18e+3		1.87	251.5
Al L _{2,3}	72.4	6.67e+4	-3.97	25.48	171.2
Si L _{2,3}	91.5	7.06e+4	16.11	34.06	135.5
Be K	108.5	4.35e+4	29.79	24.89	114.3
Sr M ζ	114.0	3.49e+4	30.71	21.01	108.8
Y M ζ	132.8	1.99e+4	30.62	13.95	93.4
Zr M ζ	151.1	1.10e+4	29.77	8.77	82.1
B K α	183.3	4.67e+3	25.81	4.52	67.6
Mo M ζ	192.6	3.83e+3	24.63	3.89	64.4
Ar L ℓ	220.1	2.73e+3	21.19	3.17	56.3
C K α	277.0	3.46e+3	14.04	5.06	44.8
Ag M ζ	311.7	6.17e+3	10.29	10.15	39.8
N K α	392.4	1.10e+4	11.54	22.70	31.6
Ti L α	452.2	1.20e+4	16.43	28.51	27.4
V L α	511.3	1.20e+4	20.67	32.49	24.2
O K α	524.9	1.21e+4	21.82	33.40	23.6
Cr L α	572.8	1.19e+4	26.26	35.89	21.6
Mn L α	637.4	1.10e+4	32.44	37.15	19.5
F K α	676.8	1.02e+4	35.73	36.58	18.3
Fe L α	705.0	9.73e+3	37.53	36.18	17.6
Co L α	776.2	8.50e+3	40.25	34.80	16.0
Ni L α	851.5	8.21e+3	44.26	36.89	14.6
Cu L α	929.7	7.06e+3	49.21	34.64	13.3
Zn L α	1011.7	6.09e+3	52.03	32.49	12.3
Na K α	1041.0	5.78e+3	52.80	31.76	11.9
Ge L α	1188.0	4.65e+3	56.02	29.14	10.4
Mg K α	1253.6	4.25e+3	57.36	28.08	9.9
Al K α	1486.7	3.05e+3	60.45	23.92	8.3
Si K α	1740.0	2.20e+3	61.82	20.23	7.1
Zr L α	2042.4	1.56e+3	61.79	16.82	6.1
Mo L α	2293.2	1.20e+3	60.60	14.58	5.4
Cl K α	2622.4	8.84e+2	56.28	12.23	4.7
Ag L α	2984.3	2.02e+3	43.15	31.80	4.2
Ca K α	3691.7	1.68e+3	68.62	32.68	3.4
Ti K α	4510.8	1.10e+3	76.18	26.18	2.7
V K α	4952.2	8.76e+2	79.17	22.90	2.5
Cr K α	5414.7	7.03e+2	80.67	20.09	2.3
Mn K α	5898.8	5.68e+2	81.59	17.69	2.1
Co K α	6930.3	3.79e+2	82.39	13.85	1.8
Ni K α	7478.2	3.12e+2	82.48	12.33	1.7
Cu K α	8047.8	2.59e+2	82.46	11.01	1.5
Ge K α	9886.4	1.53e+2	81.99	7.98	1.3
Y K α	14988.0	1.22e+2	77.73	9.68	0.8
Mo K α	17479.0	1.04e+2	78.04	9.58	0.7
Pd K α	21177.0	7.98e+1	83.56	8.91	0.6
Sn K α	25271.0	5.07e+1	84.79	6.77	0.5
Xe K α	29779.0	3.30e+1	85.19	5.18	0.4

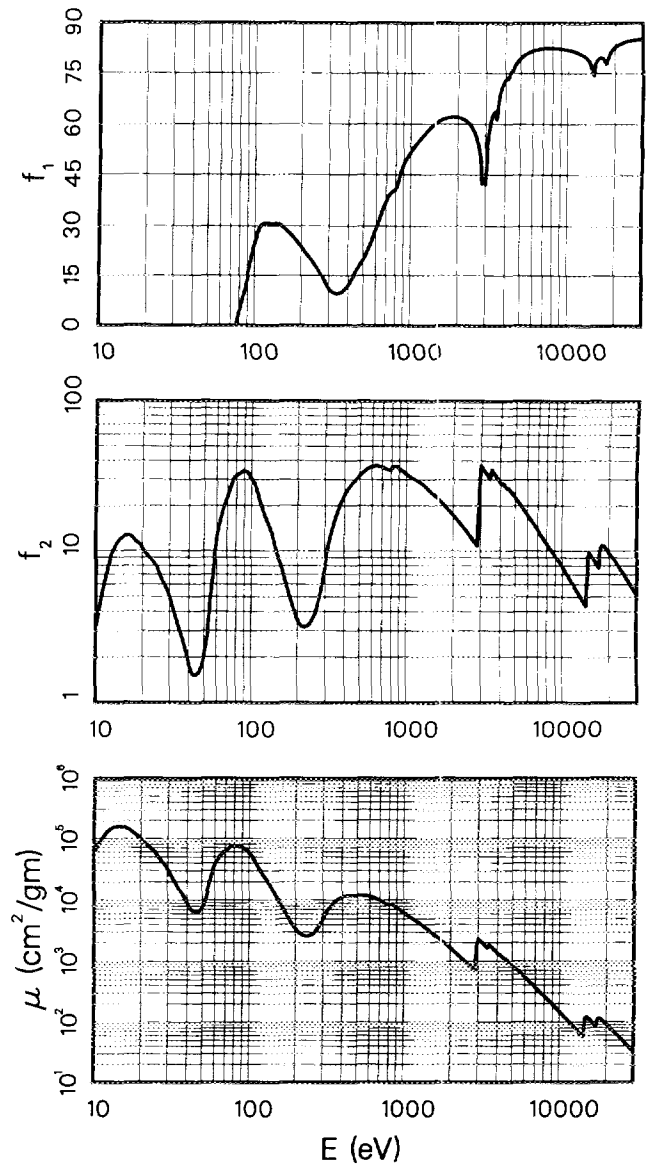

Edge Energies

L _I	18049. eV	M _I	4482. eV	N _I	1097. eV ^a	O _I	214. eV ^a
L _{II}	17337.1 eV	M _{II}	4159. eV	N _{II}	929. eV ^a	O _{II}	164. eV ^a
L _{III}	14619.4 eV	M _{III}	3538. eV	N _{III}	768. eV ^a	O _{III}	127. eV ^a
		M _{IV}	3021.5 eV	N _{IV}	567. eV ^a	O _{IV}	48. eV ^a
		M _V	2892.4 eV	N _V	54... eV ^a	O _V	48. eV ^a
				N _{VI}	238. eV ^a		
				N _{VII}	238. eV ^a		

TABLE I. Photoabsorption Cross Sections and Atomic Scattering Factors,
 $Z = 1-92$, $E = 50-30,000$ eV
 See page 211 for Explanation of Tables

$\mu_a(\text{barns/atom}) = \mu(\text{cm}^2/\text{gm}) \times 370.34$
 $E(\text{keV})\mu(\text{cm}^2/\text{gm}) = f_2 \times 188.67$

Francium (Fr)
 $Z = 87$
 Atomic Weight = 223.020

Line	E(eV)	$\mu(\text{cm}^2/\text{gm})$	f_1	f_2	$\lambda(\text{\AA})$
H	10.2	1.17e+3		0.06	1215
He I	21.2	1.01e+5		11.31	584.3
Na L _{2,3}	30.5	4.11e+4		6.64	407.2
Mg L _{2,3}	49.3	4.99e+3		1.30	251.5
Al L _{2,3}	72.4	6.27e+4	-17.10	24.05	171.2
Si L _{2,3}	91.5	8.21e+4	7.40	39.83	135.5
Be K	108.5	5.95e+4	27.74	34.23	114.3
Sr M ζ	114.0	4.95e+4	30.27	29.94	108.8
Y M ζ	132.8	2.91e+4	32.92	20.45	93.4
Zr M ζ	151.1	1.72e+4	33.55	13.74	82.1
B K α	183.3	6.83e+3	30.15	6.63	67.6
Mo M ζ	192.6	5.33e+3	28.93	5.44	64.4
Ar L ℓ	220.1	3.15e+3	25.07	3.67	56.3
C K α	277.0	2.87e+3	17.93	4.22	44.8
Ag M ζ	311.7	4.08e+3	13.65	6.74	39.8
N K α	392.4	9.52e+3	10.59	19.81	31.6
Ti L α	452.2	1.13e+4	14.20	27.04	27.4
V L α	511.3	1.19e+4	19.29	32.17	24.2
O K α	524.9	1.19e+4	20.38	32.97	23.6
Cr L α	572.8	1.17e+4	24.06	35.48	21.6
Mn L α	637.4	1.18e+4	30.82	39.79	19.5
F K α	676.8	1.09e+4	35.80	39.09	18.3
Fe L α	705.0	1.02e+4	38.00	38.19	17.6
Co L α	776.2	8.79e+3	42.28	36.16	16.0
Ni L α	851.5	7.65e+3	44.25	34.52	14.6
Cu L α	929.7	7.28e+3	47.45	35.87	13.3
Zn L α	1011.7	6.36e+3	51.69	34.08	12.3
Na K α	1041.0	6.04e+3	52.65	33.32	11.9
Ge L α	1188.0	4.87e+3	56.47	30.66	10.4
Mg K α	1253.6	4.45e+3	58.05	29.57	9.9
Al K α	1486.7	3.18e+3	61.56	25.04	8.3
Si K α	1740.0	2.29e+3	63.15	21.14	7.1
Zr L α	2042.4	1.62e+3	63.39	17.58	6.1
Mo L α	2293.2	1.26e+3	62.56	15.28	5.4
Cl K α	2622.4	9.26e+2	59.49	12.88	4.7
Ag L α	2984.3	1.12e+3	42.71	17.67	4.2
Ca K α	3691.7	1.58e+3	62.01	30.99	3.4
Ti K α	4510.8	1.10e+3	76.35	26.23	2.7
V K α	4952.2	9.11e+2	79.32	23.92	2.5
Cr K α	5414.7	7.31e+2	81.17	20.99	2.3
Mn K α	5898.8	5.91e+2	82.28	18.48	2.1
Co K α	6930.3	3.94e+2	83.28	14.47	1.8
Ni K α	7478.2	3.25e+2	83.43	12.87	1.7
Cu K α	8047.8	2.69e+2	83.45	11.49	1.5
Ge K α	9886.4	1.60e+2	83.00	8.37	1.3
Y K α	14988.0	8.57e+1	75.21	6.81	0.8
Mo K α	17479.0	8.36e+1	80.09	7.75	0.7
Pd K α	21177.0	8.28e+1	84.17	9.30	0.6
Sn K α	25271.0	5.27e+1	85.63	7.06	0.5
Xe K α	29779.0	3.43e+1	86.11	5.41	0.4

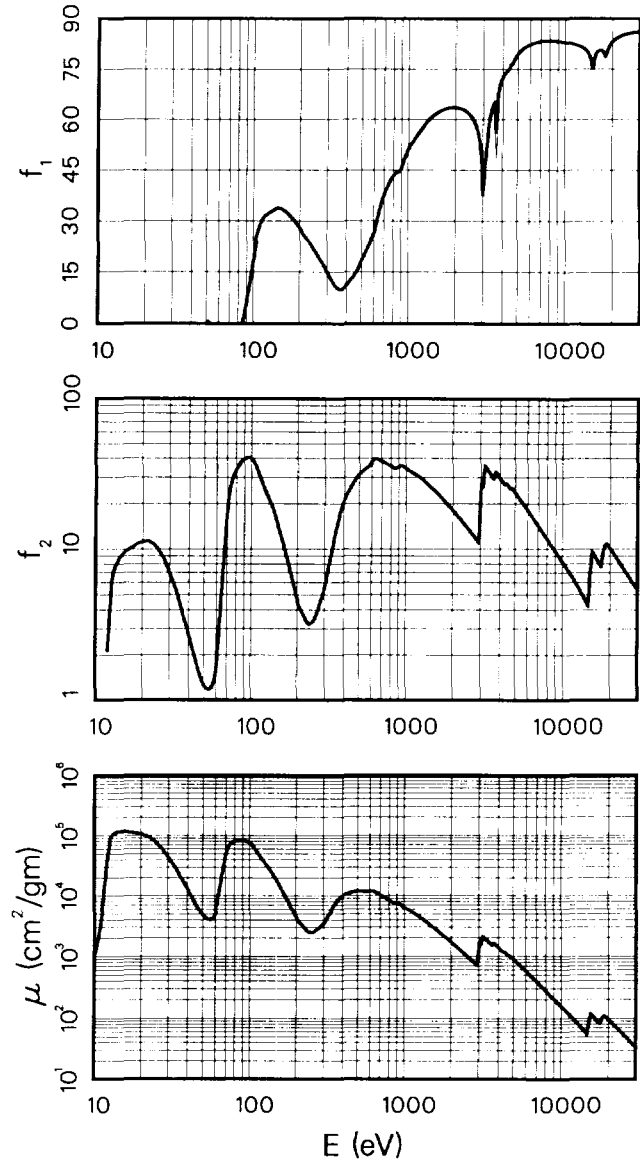

Edge Energies

L _I	18639. eV	M _I	4652. eV	N _I	1153. eV ^a	O _I	234. eV ^a
L _{II}	17906.5 eV	M _{II}	4327. eV	N _{II}	980. eV ^a	O _{II}	182. eV ^a
L _{III}	15031.2 eV	M _{III}	3663. eV	N _{III}	810. eV ^a	O _{III}	140. eV ^a
		M _{IV}	3136.2 eV	N _{IV}	603. eV ^a	O _{IV}	58. eV ^a
		M _V	2999.9 eV	N _V	577. eV ^a	O _V	58. eV ^a
				N _{VI}	268. eV ^a		
				N _{VII}	268. eV ^a		

TABLE I. Photoabsorption Cross Sections and Atomic Scattering Factors,
 $Z = 1-92$, $E = 50-30,000$ eV
 See page 211 for Explanation of Tables

Radium (Ra)
 $Z = 88$
 Atomic Weight = 226.030

$\mu_a(\text{barns/atom}) = \mu(\text{cm}^2/\text{gm}) \times 375.34$
 $E(\text{keV})\mu(\text{cm}^2/\text{gm}) = f_2 \times 186.16$

Line	E(eV)	$\mu(\text{cm}^2/\text{gm})$	f_1	f_2	$\lambda(\text{\AA})$
H	10.2	8.31e+2		0.05	1215
He I	21.2	9.33e+4		10.63	584.3
Na L _{2,3}	30.5	5.26e+4		8.60	407.2
Mg L _{2,3}	49.3	7.28e+3		1.93	251.5
Al L _{2,3}	72.4	1.49e+4	-15.99	5.81	171.2
Si L _{2,3}	91.5	8.82e+4	7.80	43.37	135.5
Be K	108.5	5.92e+4	29.31	34.53	114.3
Sr M ζ	114.0	5.00e+4	32.12	30.62	108.8
Y M ζ	132.8	2.73e+4	36.02	19.51	93.4
Zr M ζ	151.1	1.54e+4	35.29	12.48	82.1
B K α	183.3	5.87e+3	31.58	5.78	67.6
Mo M ζ	192.6	4.79e+3	30.29	4.95	64.4
Ar L l	220.1	2.78e+3	27.18	3.29	56.3
C K α	277.0	2.09e+3	21.04	3.12	44.8
Ag M ζ	311.7	2.65e+3	17.10	4.44	39.8
N K α	392.4	7.36e+3	10.01	15.52	31.6
Ti L α	452.2	1.05e+4	13.42	25.44	27.4
V L α	511.3	1.11e+4	19.15	30.41	24.2
O K α	524.9	1.11e+4	20.27	31.17	23.6
Cr L α	572.8	1.08e+4	23.61	33.36	21.6
Mn L α	637.4	1.07e+4	28.55	36.73	19.5
F K α	676.8	1.05e+4	31.99	38.14	18.3
Fe L α	705.0	1.03e+4	34.98	38.84	17.6
Co L α	776.2	8.99e+3	40.98	37.49	16.0
Ni L α	851.5	7.77e+3	44.81	35.55	14.6
Cu L α	929.7	6.79e+3	46.53	33.91	13.3
Zn L α	1011.7	6.51e+3	49.44	35.40	12.3
Na K α	1041.0	6.24e+3	51.19	34.87	11.9
Ge L α	1188.0	5.07e+3	56.13	32.37	10.4
Mg K α	1253.6	4.65e+3	58.09	31.31	9.9
Al K α	1486.7	3.30e+3	62.29	26.36	8.3
Si K α	1740.0	2.38e+3	64.20	22.29	7.1
Zr L α	2042.4	1.69e+3	64.80	18.55	6.1
Mo L α	2293.2	1.31e+3	64.31	16.11	5.4
Cl K α	2622.4	9.63e+2	62.06	13.56	4.7
Ag L α	2984.3	7.10e+2	53.65	11.39	4.2
Ca K α	3691.7	1.52e+3	66.10	30.11	3.4
Ti K α	4510.8	1.13e+3	75.78	27.38	2.7
V K α	4952.2	9.38e+2	79.23	24.96	2.5
Cr K α	5414.7	7.53e+2	81.67	21.91	2.3
Mn K α	5898.8	6.09e+2	82.98	19.29	2.1
Co K α	6930.3	4.06e+2	84.21	15.11	1.8
Ni K α	7478.2	3.35e+2	84.43	13.44	1.7
Cu K α	8047.8	2.78e+2	84.51	12.00	1.5
Ge K α	9886.4	1.64e+2	84.28	8.70	1.3
Y K α	14988.0	5.32e+1	79.14	4.29	0.8
Mo K α	17479.0	8.64e+1	81.49	8.11	0.7
Pd K α	21177.0	8.54e+1	84.68	9.71	0.6
Sn K α	25271.0	5.42e+1	86.45	7.36	0.5
Xe K α	29779.0	3.52e+1	87.02	5.64	0.4

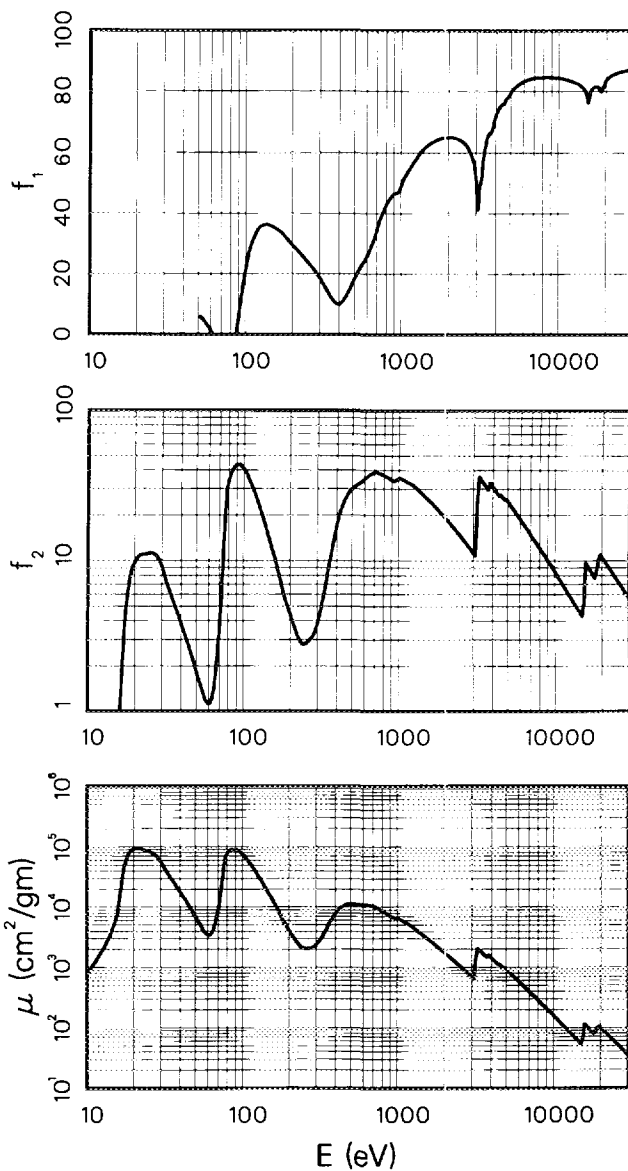

Edge Energies

L _I	19236.7 eV	M _I	4822.0 eV	N _I	1208.4 eV	O _I	254. eV ^a
L _{II}	18484.3 eV	M _{II}	4489.5 eV	N _{II}	1057.6 eV	O _{II}	200. eV ^a
L _{III}	15444.4 eV	M _{III}	3791.8 eV	N _{III}	879.1 eV	O _{III}	153. eV ^a
		M _{IV}	3248.4 eV	N _{IV}	635.9 eV	O _{IV}	68. eV ^a
		M _V	3104.9 eV	N _V	602.7 eV	O _V	68. eV ^a
				N _{VI}	289. eV ^a		
				N _{VII}	289. eV ^a		

TABLE I. Photoabsorption Cross Sections and Atomic Scattering Factors,
 $Z = 1-92$, $E = 50-30,000$ eV
 See page 211 for Explanation of Tables

$\mu_a(\text{barns/atom}) = \mu(\text{cm}^2/\text{gm}) \times 376.98$
 $E(\text{keV})\mu(\text{cm}^2/\text{gm}) = f_2 \times 185.35$

Actinium (Ac)
 $Z = 89$
 Atomic Weight = 227.020

Line	E(eV)	$\mu(\text{cm}^2/\text{gm})$	f_1	f_2	λ (Å)
H	10.2	2.09e+4		1.15	1215
He I	21.2	7.64e+4		8.75	584.3
Na L _{2,3}	30.5	6.78e+4		11.15	407.2
Mg L _{2,3}	49.3	8.80e+3		2.34	251.5
Al L _{2,3}	72.4	3.91e+3	2.57	1.53	171.2
Si L _{2,3}	91.5	7.15e+4	-7.12	35.29	135.5
Be K	108.5	6.95e+4	20.01	40.69	114.3
Sr M ζ	114.0	6.27e+4	27.50	38.58	108.8
Y M ζ	132.8	3.29e+4	37.28	23.60	93.4
Zr M ζ	151.1	1.86e+4	37.58	15.16	82.1
B K α	183.3	6.75e+3	34.50	6.67	67.6
Mo M ζ	192.6	5.20e+3	33.09	5.40	64.4
Ar L ℓ	220.1	3.05e+3	29.74	3.62	56.3
C K α	277.0	1.90e+3	24.22	2.84	44.8
Ag M ζ	311.7	1.96e+3	20.90	3.29	39.8
N K α	392.4	5.46e+3	10.94	11.56	31.6
Ti L α	452.2	9.52e+3	12.82	23.22	27.4
V L α	511.3	1.08e+4	17.67	29.75	24.2
O K α	524.9	1.10e+4	19.01	31.10	23.6
Cr L α	572.8	1.11e+4	23.90	34.16	21.6
Mn L α	637.4	1.05e+4	30.27	36.00	19.5
F K α	676.8	9.91e+3	32.73	36.19	18.3
Fe L α	705.0	9.70e+3	34.65	36.91	17.6
Co L α	776.2	8.89e+3	39.79	37.25	16.0
Ni L α	851.5	7.90e+3	44.51	36.31	14.6
Cu L α	929.7	6.93e+3	46.83	34.75	13.3
Zn L α	1011.7	6.62e+3	50.20	36.15	12.3
Na K α	1041.0	6.34e+3	52.17	35.61	11.9
Ge L α	1188.0	4.99e+3	57.16	31.97	10.4
Mg K α	1253.6	4.53e+3	58.47	30.63	9.9
Al K α	1486.7	3.41e+3	62.44	27.39	8.3
Si K α	1740.0	2.48e+3	65.21	23.31	7.1
Zr L α	2042.4	1.76e+3	66.31	19.44	6.1
Mo L α	2293.2	1.36e+3	66.19	16.88	5.4
Cl K α	2622.4	1.00e+3	64.64	14.18	4.7
Ag L α	2984.3	7.36e+2	59.56	11.85	4.2
Ca K α	3691.7	1.56e+3	66.22	30.99	3.4
Ti K α	4510.8	1.09e+3	76.76	26.63	2.7
V K α	4952.2	9.38e+2	79.14	25.06	2.5
Cr K α	5414.7	7.71e+2	81.90	22.52	2.3
Mn K α	5898.8	6.25e+2	83.48	19.89	2.1
Co K α	6930.3	4.18e+2	85.00	15.61	1.8
Ni K α	7478.2	3.44e+2	85.31	13.89	1.7
Cu K α	8047.8	2.85e+2	85.44	12.39	1.5
Ge K α	9886.4	1.68e+2	85.29	8.95	1.3
Y K α	14988.0	5.51e+1	81.43	4.46	0.8
Mo K α	17479.0	9.00e+1	82.22	8.49	0.7
Pd K α	21177.0	8.80e+1	84.86	10.06	0.6
Sn K α	25271.0	5.65e+1	87.12	7.70	0.5
Xe K α	29779.0	3.69e+1	87.86	5.93	0.4

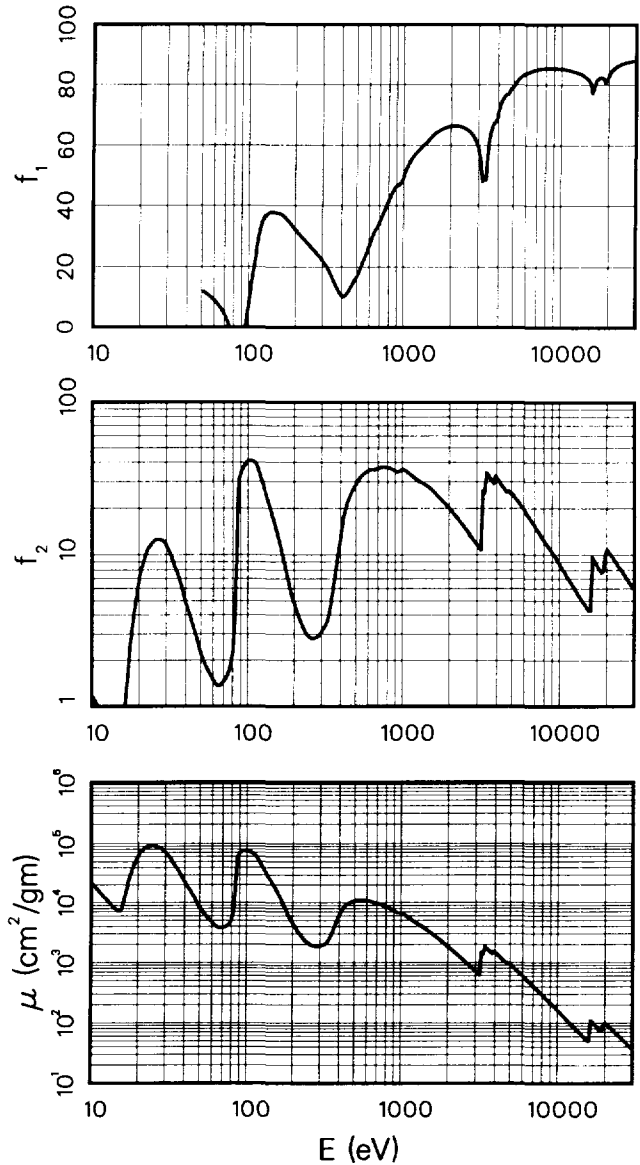

Edge Energies

L _I	19840. eV	M _I	5002. eV	N _I	1269. eV ^a	O _I	272. eV ^a
L _{II}	19083.2 eV	M _{II}	4656. eV	N _{II}	1080. eV ^a	O _{II}	215. eV ^a
L _{III}	15871.0 eV	M _{III}	3909. eV	N _{III}	890. eV ^a	O _{III}	167. eV ^a
		M _{IV}	3370.2 eV	N _{IV}	675. eV ^a	O _{IV}	80. eV ^a
		M _V	3219.0 eV	N _V	639. eV ^a	O _V	80. eV ^a
				N _{VI}	319. eV ^a		
				N _{VII}	319. eV ^a		

TABLE I. Photoabsorption Cross Sections and Atomic Scattering Factors,
 $Z = 1-92$, $E = 50-30,000$ eV
 See page 211 for Explanation of Tables

Thorium (Th)
 $Z = 90$

Atomic Weight = 232.038

$\mu_a(\text{barns/atom}) = \mu(\text{cm}^2/\text{gm}) \times 385.31$
 $E(\text{keV})\mu(\text{cm}^2/\text{gm}) = f_2 \times 181.34$

Line	E(eV)	$\mu(\text{cm}^2/\text{gm})$	f_1	f_2	$\lambda(\text{\AA})$
H	10.2	5.49e + 4		3.09	1215
He I	21.2	7.50e + 4		8.78	584.3
Na L _{2,3}	30.5	7.54e + 4		12.67	407.2
Mg L _{2,3}	49.3	2.10e + 4		5.71	251.5
Al L _{2,3}	72.4	7.75e + 3	13.59	3.09	171.2
Si L _{2,3}	91.5	3.44e + 4	0.60	17.35	135.5
Be K	108.5	1.06e + 5	28.32	63.66	114.3
Sr M ζ	114.0	6.22e + 4	42.65	39.11	108.8
Y M ζ	132.8	2.47e + 4	41.96	18.09	93.4
Zr M ζ	151.1	1.35e + 4	39.96	11.28	82.1
B K α	183.3	4.07e + 3	34.92	4.11	67.6
Mo M ζ	192.6	3.28e + 3	33.62	3.48	64.4
Ar L l	220.1	2.39e + 3	30.47	2.90	56.3
C K α	277.0	2.23e + 3	26.59	3.41	44.8
Ag M ζ	311.7	2.26e + 3	24.57	3.89	39.8
N K α	392.4	4.08e + 3	17.50	8.83	31.6
Ti L α	452.2	6.88e + 3	16.07	17.15	27.4
V L α	511.3	8.57e + 3	19.90	24.17	24.2
O K α	524.9	8.66e + 3	20.84	25.06	23.6
Cr L α	572.8	8.85e + 3	23.85	27.96	21.6
Mn L α	637.4	8.89e + 3	27.82	31.24	19.5
F K α	676.8	8.85e + 3	30.45	33.03	18.3
Fe L α	705.0	8.78e + 3	32.74	34.15	17.6
Co L α	776.2	8.05e + 3	38.08	34.44	16.0
Ni L α	851.5	7.19e + 3	41.79	33.77	14.6
Cu L α	929.7	6.62e + 3	44.06	33.95	13.3
Zn L α	1011.7	6.14e + 3	47.31	34.27	12.3
Na K α	1041.0	6.27e + 3	48.28	36.00	11.9
Ge L α	1188.0	5.01e + 3	55.49	32.83	10.4
Mg K α	1253.6	4.57e + 3	57.08	31.58	9.9
Al K α	1486.7	3.50e + 3	61.92	28.67	8.3
Si K α	1740.0	2.54e + 3	65.34	24.37	7.1
Zr L α	2042.4	1.81e + 3	66.81	20.34	6.1
Mo L α	2293.2	1.40e + 3	66.96	17.70	5.4
Cl K α	2622.4	1.03e + 3	65.87	14.94	4.7
Ag L α	2984.3	7.64e + 2	62.30	12.57	4.2
Ca K α	3691.7	1.62e + 3	63.90	32.88	3.4
Ti K α	4510.8	1.14e + 3	76.59	28.29	2.7
V K α	4952.2	9.55e + 2	78.88	26.07	2.5
Cr K α	5414.7	8.02e + 2	81.91	23.94	2.3
Mn K α	5898.8	6.49e + 2	83.90	21.12	2.1
Co K α	6930.3	4.34e + 2	85.74	16.58	1.8
Ni K α	7478.2	3.58e + 2	86.14	14.75	1.7
Cu K α	8047.8	2.97e + 2	86.33	13.17	1.5
Ge K α	9886.4	1.75e + 2	86.20	9.57	1.3
Y K α	14988.0	5.93e + 1	83.35	4.90	0.8
Mo K α	17479.0	9.21e + 1	82.80	8.88	0.7
Pd K α	21177.0	9.04e + 1	85.02	10.56	0.6
Sn K α	25271.0	5.76e + 1	87.93	8.03	0.5
Xe K α	29779.0	3.76e + 1	88.76	6.17	0.4

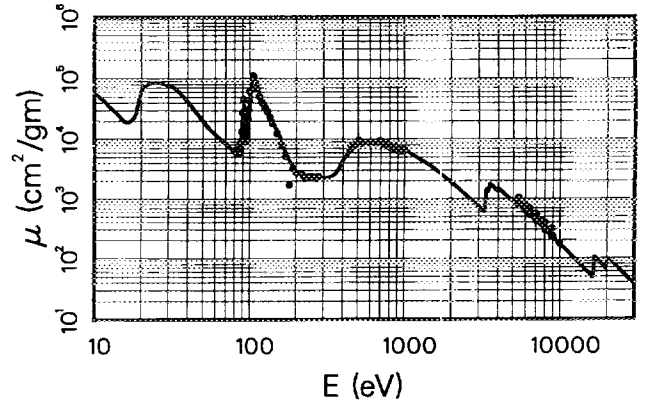
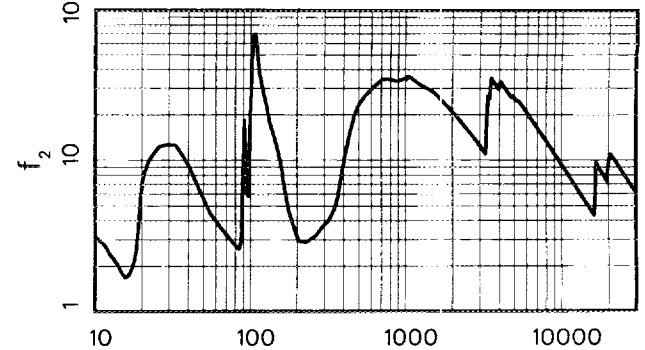
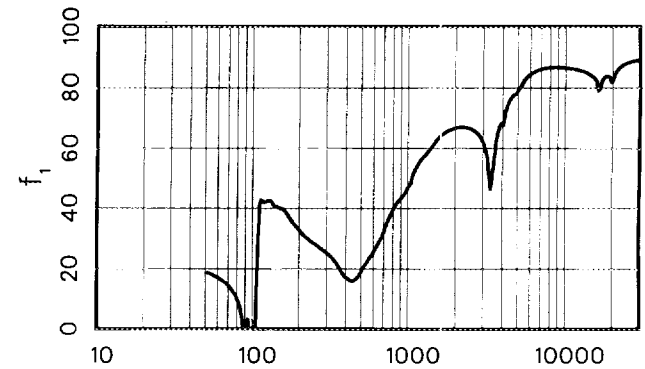

Edge Energies

L _I	20472.1 eV	M _I	5182.3 eV	N _I	1331. eV ^a	O _I	290. eV ^a
L _{II}	19693.2 eV	M _{II}	4830.4 eV	N _{II}	1163. eV ^a	O _{II}	229. eV ^a
L _{III}	16300.3 eV	M _{III}	4046.1 eV	N _{III}	966.4 eV ^b	O _{III}	182. eV ^a
		M _{IV}	3490.8 eV	N _{IV}	712.1 eV ^b	O _{IV}	92.5 eV ^b
		M _V	3332.0 eV	N _V	675.2 eV ^b	O _V	85.4 eV ^b
				N _{VI}	342.4 eV ^b		
				N _{VII}	333.1 eV ^b		

References: 50, 104, 230.

TABLE I. Photoabsorption Cross Sections and Atomic Scattering Factors,

Z = 1-92, E = 50-30,000 eV

See page 211 for Explanation of Tables

$\mu_a(\text{barns/atom}) = \mu(\text{cm}^2/\text{gm}) \times 383.65$
 $E(\text{keV})\mu(\text{cm}^2/\text{gm}) = f_2 \times 182.13$

Protactinium (Pa)

Z = 91

Atomic Weight = 231.036

Line	E(eV)	$\mu(\text{cm}^2/\text{gm})$	f_1	f_2	$\lambda(\text{\AA})$
H	10.2	3.15e+4		1.76	1215
He I	21.2	4.60e+4		5.36	584.3
Na L _{2,3}	30.5	7.93e+4		13.26	407.2
Mg L _{2,3}	49.3	3.44e+4		9.30	251.5
Al L _{2,3}	72.4	8.58e+3	13.02	3.41	171.2
Si L _{2,3}	91.5	6.74e+3	-3.81	3.39	135.5
Be K	108.5	8.75e+4	-24.83	52.12	114.3
Sr M ζ	114.0	1.05e+5	35.00	65.89	108.8
Y M ζ	132.8	3.02e+4	39.37	22.01	93.4
Zr M ζ	151.1	1.61e+4	37.42	13.37	82.1
B K α	183.3	7.29e+3	33.34	7.34	67.6
Mo M ζ	192.6	6.10e+3	32.69	6.45	64.4
Ar L ℓ	220.1	3.71e+3	30.52	4.48	56.3
C K α	277.0	2.13e+3	25.76	3.24	44.8
Ag M ζ	311.7	2.08e+3	23.30	3.55	39.8
N K α	392.4	3.25e+3	15.61	7.00	31.6
Ti L α	452.2	6.42e+3	11.75	15.95	27.4
V L α	511.3	8.80e+3	14.35	24.70	24.2
O K α	524.9	9.13e+3	15.39	26.31	23.6
Cr L α	572.8	9.76e+3	19.62	30.71	21.6
Mn L α	637.4	9.57e+3	25.03	33.48	19.5
F K α	676.8	9.32e+3	26.37	34.63	18.3
Fe L α	705.0	9.70e+3	28.13	37.53	17.6
Co L α	776.2	9.23e+3	36.40	39.34	16.0
Ni L α	851.5	8.15e+3	42.02	38.10	14.6
Cu L α	929.7	7.12e+3	45.86	36.36	13.3
Zn L α	1011.7	6.32e+3	48.62	35.08	12.3
Na K α	1041.0	6.05e+3	49.51	34.57	11.9
Ge L α	1188.0	5.17e+3	53.34	33.71	10.4
Mg K α	1253.6	4.84e+3	55.30	33.33	9.9
Al K α	1486.7	3.73e+3	61.13	30.46	8.3
Si K α	1740.0	2.74e+3	64.97	26.15	7.1
Zr L α	2042.4	1.96e+3	66.85	21.97	6.1
Mo L α	2293.2	1.52e+3	67.29	19.15	5.4
Cl K α	2622.4	1.12e+3	66.57	16.16	4.7
Ag L α	2984.3	8.28e+2	63.76	13.57	4.2
Ca K α	3691.7	1.86e+3	56.43	37.63	3.4
Ti K α	4510.8	1.22e+3	76.31	30.21	2.7
V K α	4952.2	9.95e+2	78.51	27.06	2.5
Cr K α	5414.7	8.50e+2	81.59	25.28	2.3
Mn K α	5898.8	6.95e+2	84.10	22.51	2.1
Co K α	6930.3	4.65e+2	86.30	17.70	1.8
Ni K α	7478.2	3.84e+2	86.81	15.75	1.7
Cu K α	8047.8	3.18e+2	87.08	14.05	1.5
Ge K α	9886.4	1.87e+2	87.18	10.13	1.3
Y K α	14988.0	6.30e+1	83.81	5.18	0.8
Mo K α	17479.0	1.05e+2	82.25	10.10	0.7
Pd K α	21177.0	9.96e+1	84.19	11.58	0.6
Sn K α	25271.0	6.51e+1	88.52	9.03	0.5
Xe K α	29779.0	4.28e+1	89.72	7.01	0.4

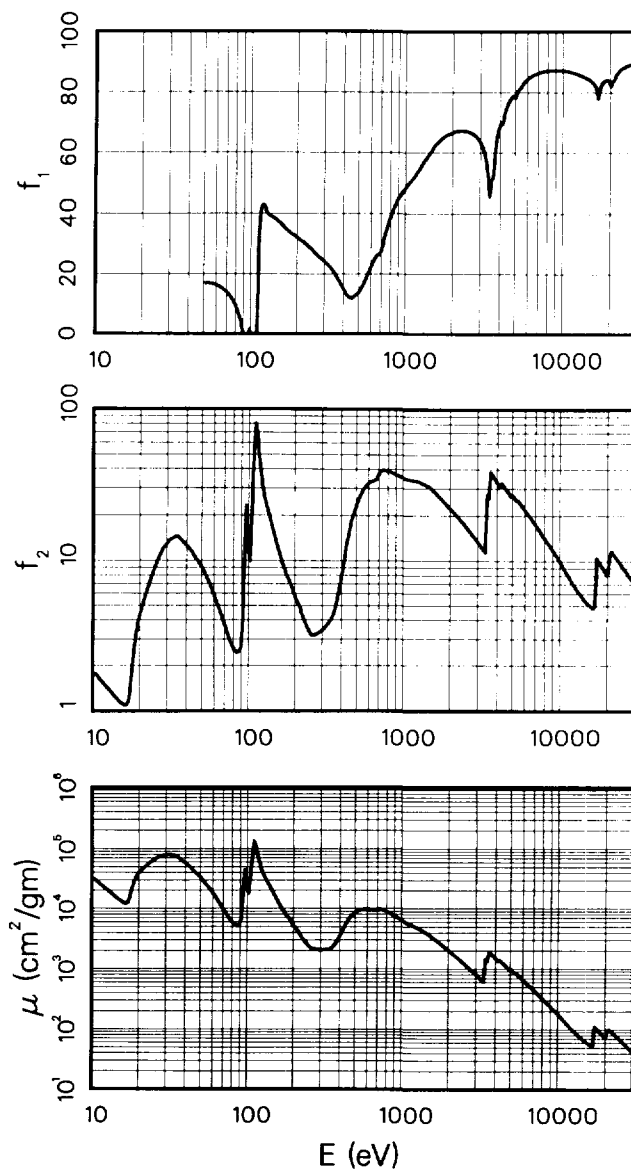

Edge Energies

L _I	21104.6 eV	M _I	5366.9 eV	N _I	1387. eV ^a	O _I	310. eV ^a
L _{II}	20313.7 eV	M _{II}	5000.9 eV	N _{II}	1224. eV ^a	O _{II}	232. eV ^a
L _{III}	16733.1 eV	M _{III}	4173.8 eV	N _{III}	1007. eV ^a	O _{III}	232. eV ^a
		M _{IV}	3611.2 eV	N _{IV}	743. eV ^a	O _{IV}	94. eV ^a
		M _V	3441.8 eV	N _V	708. eV ^a	O _V	94. eV ^a
				N _{VI}	371. eV ^a		
				N _{VII}	360. eV ^a		

TABLE I. Photoabsorption Cross Sections and Atomic Scattering Factors,
 $Z = 1-92$, $E = 50-30,000$ eV
 See page 211 for Explanation of Tables

$\mu_a(\text{barns/atom}) = \mu(\text{cm}^2/\text{gm}) \times 395.26$
 $E(\text{keV})\mu(\text{cm}^2/\text{gm}) = f_2 \times 176.78$

Uranium (U)
 $Z = 92$
 Atomic Weight = 238.029

Line	E(eV)	$\mu(\text{cm}^2/\text{gm})$	f_1	f_2	λ (Å)
H	10.2	2.79e+4		1.61	1215
He I	21.2	6.94e+4		8.33	584.3
Na L _{2,3}	30.5	7.81e+4		13.45	407.2
Mg L _{2,3}	49.3	4.55e+4		12.68	251.5
Al L _{2,3}	72.4	1.64e+4	19.85	6.72	171.2
Si L _{2,3}	91.5	3.88e+3	7.60	2.01	135.5
Be K	108.5	2.02e+4	-11.73	12.42	114.3
Sr M ζ	114.0	8.79e+4	-44.16	56.66	108.8
Y M ζ	132.8	4.49e+4	52.13	33.77	93.4
Zr M ζ	151.1	2.51e+4	48.51	21.41	82.1
B K α	183.3	9.60e+3	45.87	9.96	67.6
Mo M ζ	192.6	7.31e+3	44.40	7.96	64.4
Ar L ℓ	220.1	4.36e+3	40.93	5.43	56.3
C K α	277.0	2.25e+3	36.29	3.52	44.8
Ag M ζ	311.7	1.98e+3	34.13	3.49	39.8
N K α	392.4	2.15e+3	29.29	4.77	31.6
Ti L α	452.2	3.24e+3	25.29	8.28	27.4
V L α	511.3	4.91e+3	23.70	14.21	24.2
O K α	524.9	5.26e+3	23.75	15.61	23.6
Cr L α	572.8	6.34e+3	25.56	20.55	21.6
Mn L α	637.4	6.09e+3	29.07	21.96	19.5
F K α	676.8	6.02e+3	28.42	23.04	18.3
Fe L α	705.0	6.29e+3	27.78	25.10	17.6
Co L α	776.2	7.32e+3	29.38	32.12	16.0
Ni L α	851.5	8.04e+3	36.03	38.73	14.6
Cu L α	929.7	7.63e+3	44.67	40.15	13.3
Zn L α	1011.7	6.77e+3	53.58	38.73	12.3
Na K α	1041.0	6.10e+3	53.53	35.95	11.9
Ge L α	1188.0	5.02e+3	57.98	33.71	10.4
Mg K α	1253.6	4.61e+3	59.87	32.72	9.9
Al K α	1486.7	3.39e+3	65.34	28.48	8.3
Si K α	1740.0	2.46e+3	68.73	24.26	7.1
Zr L α	2042.4	1.73e+3	70.25	19.94	6.1
Mo L α	2293.2	1.33e+3	70.55	17.29	5.4
Cl K α	2622.4	9.76e+2	69.99	14.48	4.7
Ag L α	2984.3	7.23e+2	68.06	12.20	4.2
Ca K α	3691.7	1.20e+3	55.80	24.99	3.4
Ti K α	4510.8	1.08e+3	73.72	27.50	2.7
V K α	4952.2	8.78e+2	77.36	24.61	2.5
Cr K α	5414.7	7.98e+2	80.08	24.44	2.3
Mn K α	5898.8	6.31e+2	82.98	21.07	2.1
Co K α	6930.3	4.41e+2	85.03	17.30	1.8
Ni K α	7478.2	3.75e+2	85.98	15.87	1.7
Cu K α	8047.8	3.08e+2	86.58	14.03	1.5
Ge K α	9886.4	2.00e+2	86.69	11.16	1.3
Y K α	14988.0	6.61e+1	85.53	5.60	0.8
Mo K α	17479.0	8.60e+1	81.32	8.50	0.7
Pd K α	21177.0	8.72e+1	83.15	10.45	0.6
Sn K α	25271.0	6.52e+1	89.10	9.32	0.5
Xe K α	29779.0	4.30e+1	90.50	7.24	0.4

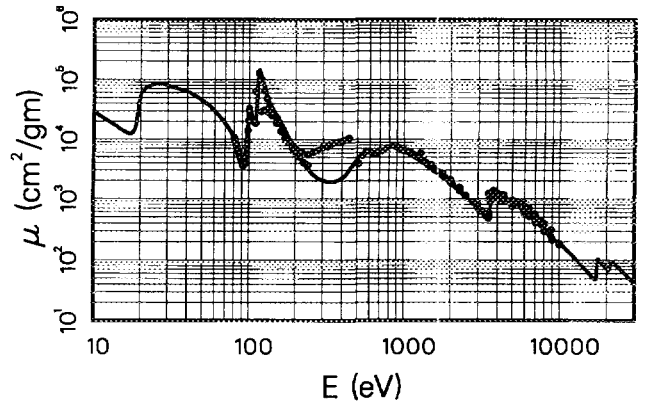
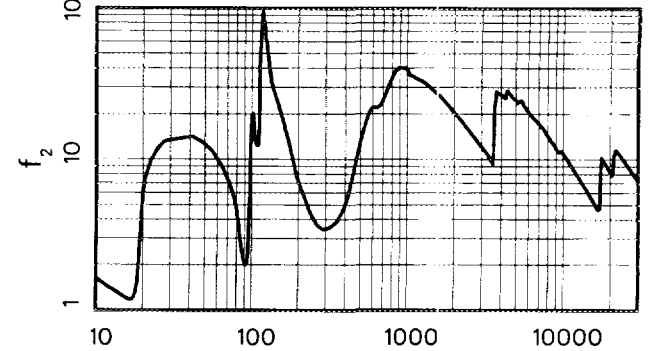
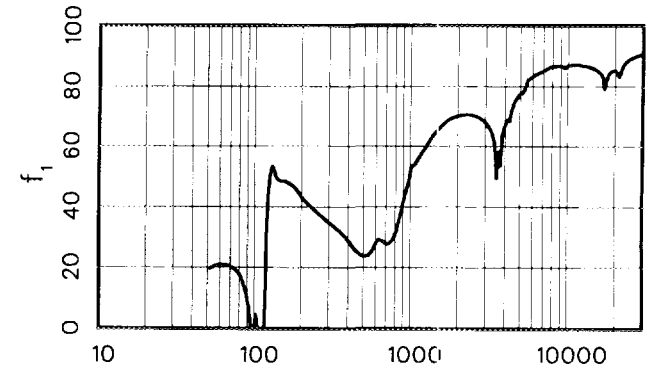

Edge Energies

L _I	21757.4 eV	M _I	5548.0 eV	N _I	1439. eV ^a	O _I	321. eV ^a
L _{II}	20947.6 eV	M _{II}	5182.2 eV	N _{II}	1271. eV ^a	O _{II}	257. eV ^a
L _{III}	17166.3 eV	M _{III}	4303.4 eV	N _{III}	1043.0 eV ^b	O _{III}	192. eV ^a
		M _{IV}	3727.6 eV	N _{IV}	778.3 eV ^b	O _{IV}	102.8 eV ^b
		M _V	3551.7 eV	N _V	736.2 eV ^b	O _V	94.2 eV ^b
				N _{VI}	388.2 eV ^b		
				N _{VII}	377.4 eV ^b		

References: 50, 113, 131, 166, 174, 178, 220, 229, 230.

TABLE II. Incoherent Scattering Cross Sections, $Z = 2-18$, $E = 1000-30,000$ eV
 See page 211 for Explanation of Tables

Line	E(eV)	He(2)	Li(3)	Be(4)	B(5)	C(6)	N(7)	O(8)	F(9)
Zn $L\alpha$	1011.	.0110	.0369	.0305	.0247	.0208	.0162	.0129	.0100
Na $K\alpha$	1041.	.0117	.0384	.0319	.0259	.0218	.0170	.0136	.0106
Ge $L\alpha$	1188.	.0149	.0456	.0391	.0323	.0275	.0215	.0174	.0135
Mg $K\alpha$	1253.	.0165	.0487	.0424	.0352	.0301	.0237	.0192	.0150
Al $K\alpha$	1486.	.0225	.0587	.0535	.0457	.0398	.0317	.0259	.0204
Si $K\alpha$	1740.	.0296	.0680	.0649	.0569	.0506	.0410	.0339	.0268
Zr $L\alpha$	2042.	.0387	.0770	.0768	.0696	.0633	.0523	.0438	.0351
Mo $L\alpha$	2293.	.0466	.0831	.0854	.0792	.0733	.0616	.0522	.0421
Cl $K\alpha$	2622.	.0570	.0898	.0950	.0903	.0856	.0734	.0631	.0515
Ag $L\alpha$	2984.	.0683	.0958	.103	.101	.0976	.0854	.0746	.0617
Ca $K\alpha$	3691.	.0889	.105	.116	.117	.117	.106	.0947	.0803
Ti $K\alpha$	4510.	.109	.114	.125	.129	.133	.124	.114	.0986
V $K\alpha$	4952.	.118	.118	.129	.134	.140	.131	.122	.107
Cr $K\alpha$	5414.	.127	.122	.133	.139	.145	.138	.130	.115
Mn $K\alpha$	5898.	.135	.126	.136	.143	.151	.144	.137	.122
Co $K\alpha$	6930.	.148	.133	.142	.149	.159	.154	.148	.134
Ni $K\alpha$	7478.	.154	.137	.144	.152	.162	.158	.153	.139
Cu $K\alpha$	8047.	.158	.140	.147	.154	.165	.162	.158	.144
Ge $K\alpha$	9886.	.170	.148	.153	.160	.173	.171	.168	.155
Y $K\alpha$	14988.	.185	.160	.164	.171	.184	.183	.182	.171
Mo $K\alpha$	17479.	.189	.163	.167	.174	.187	.186	.185	.174
Pd $K\alpha$	21177.	.192	.166	.170	.177	.190	.190	.189	.178
Sn $K\alpha$	25271.	.195	.168	.172	.179	.193	.192	.192	.181
Xe $K\alpha$	29779.	.196	.169	.173	.180	.194	.194	.194	.183

Line	E(eV)	Ne(10)	Na(11)	Mg(12)	Al(13)	Si(14)	P(15)	S(16)	Cl(17)	Ar(18)
Zn $L\alpha$	1011.	.0087								
Na $K\alpha$	1041.	.0092								
Ge $L\alpha$	1188.	.0119	.0221							
Mg $K\alpha$	1253.	.0131	.0239							
Al $K\alpha$	1486.	.0179	.0300	.0342						
Si $K\alpha$	1740.	.0238	.0364	.0420	.0438					
Zr $L\alpha$	2042.	.0313	.0435	.0506	.0529	.0548				
Mo $L\alpha$	2293.	.0379	.0492	.0571	.0597	.0624	.0588			
Cl $K\alpha$	2622.	.0468	.0563	.0649	.0678	.0714	.0682	.0677		
Ag $L\alpha$	2984.	.0566	.0638	.0726	.0756	.0802	.0774	.0777	.0718	
Ca $K\alpha$	3691.	.0751	.0780	.0859	.0885	.0943	.0922	.0940	.0883	.0804
Ti $K\alpha$	4510.	.0941	.0932	.0995	.101	.107	.105	.108	.103	.0952
V $K\alpha$	4952.	.103	.101	.106	.107	.113	.111	.115	.110	.102
Cr $K\alpha$	5414.	.112	.108	.113	.112	.118	.116	.120	.115	.107
Mn $K\alpha$	5898.	.120	.115	.119	.118	.124	.121	.126	.121	.113
Co $K\alpha$	6930.	.134	.127	.131	.128	.134	.131	.135	.130	.122
Ni $K\alpha$	7478.	.140	.133	.136	.133	.138	.135	.139	.134	.126
Cu $K\alpha$	8047.	.145	.138	.142	.138	.143	.139	.143	.138	.129
Ge $K\alpha$	9886.	.158	.151	.155	.150	.155	.150	.154	.148	.139
Y $K\alpha$	14988.	.176	.169	.174	.169	.174	.168	.173	.166	.155
Mo $K\alpha$	17479.	.181	.174	.179	.174	.179	.174	.178	.171	.160
Pd $K\alpha$	21177.	.185	.178	.183	.179	.184	.179	.184	.176	.165
Sn $K\alpha$	25271.	.188	.181	.187	.182	.188	.182	.188	.180	.169
Xe $K\alpha$	29779.	.191	.184	.189	.184	.191	.185	.190	.183	.171

TABLE III. Specular Reflectivity for Mirrors
See page 211 for Explanation of Tables

Beryllium (Be)
 $\rho = 1.85 \text{ gm/cm}^3$

Grazing Incidence Angle, θ (milliradians)

Line	E(eV)	5 mr	10 mr	15 mr	20 mr	30 mr	50 mr	80 mr	125 mr	200 mr	400 mr
Al L _{2,3}	72.4	99.4	98.7	98.1	97.4	96.2	93.6	89.5	82.5	60.8	.877
Si L _{2,3}	91.5	98.9	97.9	96.8	95.8	93.6	89.3	81.8	63.2	4.31	.128
Be K	108.5	83.5	69.8	58.4	48.9	34.4	17.5	6.84	2.05	.428	2.86E-2
Zr M ζ	151.1	95.9	91.9	88.1	84.4	77.4	64.6	47.9	26.7	5.90	.235
B K α	183.3	96.3	92.7	89.2	85.9	79.4	67.2	49.8	24.4	3.12	.116
Mo M ζ	192.6	96.4	92.9	89.5	86.3	79.9	67.8	50.2	23.1	2.54	9.56E-2
C K α	277.0	97.1	94.2	91.4	88.6	83.1	71.2	47.4	5.53	.486	2.16E-2
N K α	392.4	97.6	95.2	92.8	90.3	85.1	70.8	10.8	.848	.100	4.96E-3
Ti L α	452.2	97.8	95.6	93.4	91.1	85.9	67.8	4.18	.428	5.39E-2	2.73E-3
O K α	524.9	98.0	96.0	94.0	91.8	86.4	51.8	1.78	.214	2.83E-2	1.46E-3
Cr L α	572.8	98.1	96.3	94.3	92.1	86.5	23.3	1.12	.145	1.95E-2	1.02E-3
F K α	676.8	98.4	96.7	94.9	92.8	86.2	5.90	.494	6.92E-2	9.59E-3	5.07E-4
Fe L α	705.0	98.4	96.8	95.0	92.8	85.7	4.52	.407	5.80E-2	8.08E-3	4.28E-4
Co L α	776.2	98.5	97.0	95.3	93.1	83.8	2.54	.261	3.83E-2	5.40E-3	2.87E-4
Ni L α	851.5	98.6	97.2	95.5	93.3	76.2	1.53	.172	2.58E-2	3.67E-3	1.96E-4
Cu L α	929.7	98.7	97.4	95.7	93.3	28.5	.977	.116	1.78E-2	2.54E-3	1.36E-4
Zn L α	1011.7	98.8	97.5	95.9	93.1	12.1	.646	8.05E-2	1.25E-2	1.79E-3	9.64E-5
Ge L α	1188.0	99.0	97.8	96.0	91.4	3.91	.305	4.04E-2	6.38E-3	9.26E-4	4.99E-5
Mg K α	1253.6	99.0	97.9	96.0	88.8	2.85	.239	3.22E-2	5.11E-3	7.42E-4	4.01E-5
Al K α	1486.7	99.2	98.1	95.6	13.5	1.15	.113	1.57E-2	2.53E-3	3.70E-4	2.00E-5
Si K α	1740.0	99.3	98.2	85.6	4.36	.535	5.73E-2	8.21E-3	1.33E-3	1.95E-4	1.06E-5
Zr L α	2042.4	99.4	98.1	10.3	1.76	.257	2.92E-2	4.25E-3	6.94E-4	1.02E-4	5.53E-6
Nb L α	2165.9	99.4	98.1	6.69	1.30	.198	2.29E-2	3.34E-3	5.47E-4	8.04E-5	4.36E-6
Mo L α	2293.2	99.4	97.9	4.61	.976	.154	1.80E-2	2.65E-3	4.34E-4	6.38E-5	3.46E-6
Cl K α	2622.4	99.5	81.7	2.12	.515	8.65E-2	1.04E-2	1.54E-3	2.52E-4	3.71E-5	2.02E-6
Ag L α	2984.3	99.5	12.4	1.09	.285	5.00E-2	6.11E-3	9.09E-4	1.50E-4	2.21E-5	1.20E-6
Ca K α	3691.7	99.6	2.99	.398	.113	2.06E-2	2.57E-3	3.85E-4	6.35E-5	9.38E-6	5.10E-7
Ti K α	4510.8	99.5	1.04	.163	4.81E-2	9.04E-3	1.14E-3	1.72E-4	2.84E-5	4.19E-6	2.28E-7
V K α	4952.2	99.3	.664	.109	3.26E-2	6.18E-3	7.83E-4	1.18E-4	1.95E-5	2.88E-6	1.57E-7
Cr K α	5414.7	34.4	.439	7.47E-2	2.25E-2	4.30E-3	5.46E-4	8.25E-5	1.36E-5	2.02E-6	1.10E-7
Mn K α	5898.8	13.4	.298	5.21E-2	1.58E-2	3.04E-3	3.87E-4	5.85E-5	9.68E-6	1.43E-6	7.77E-8
Co K α	6930.3	4.29	.147	2.66E-2	8.18E-3	1.58E-3	2.03E-4	3.06E-5	5.07E-6	7.49E-7	4.07E-8
Ni K α	7478.2	2.75	.106	1.94E-2	6.00E-3	1.16E-3	1.49E-4	2.26E-5	3.74E-6	5.52E-7	3.01E-8
Cu K α	8047.8	1.85	7.74E-2	1.44E-2	4.45E-3	8.66E-4	1.11E-4	1.68E-5	2.79E-6	4.12E-7	2.24E-8
Ge K α	9886.4	.667	3.27E-2	6.20E-3	1.94E-3	3.78E-4	4.87E-5	7.38E-6	1.22E-6	1.81E-7	9.79E-9

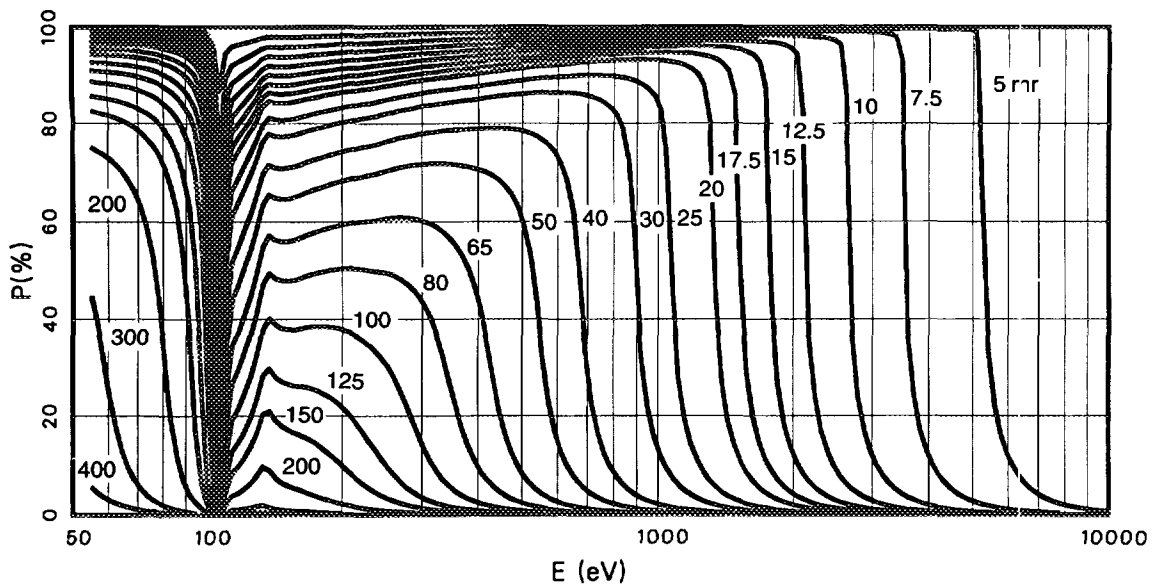

TABLE III. Specular Reflectivity for Mirrors

See page 211 for Explanation of Tables

Carbon (C)
 $\rho = 2.00 \text{ gm/cm}^3$

		Grazing Incidence Angle, θ (milliradians)										
Line	E(eV)	5 mr	10 mr	15 mr	20 mr	30 mr	50 mr	80 mr	125 mr	200 mr	400 mr	
Al	L _{2,3}	72.4	99.3	98.6	97.9	97.2	95.8	93.1	89.0	82.7	70.7	7.78
Si	L _{2,3}	91.5	99.3	98.6	98.0	97.3	96.0	93.3	89.2	82.5	66.6	1.86
Be	K	108.5	99.3	98.7	98.0	97.3	96.0	93.3	89.1	81.7	56.9	.756
Zr	M ζ	151.1	99.3	98.7	98.0	97.4	96.0	93.3	88.5	76.5	5.58	.152
B	K α	183.3	99.3	98.7	98.0	97.3	96.0	93.0	87.2	52.5	1.62	6.00E-2
Mo	M ζ	192.6	99.3	98.7	98.0	97.3	96.0	93.0	86.8	29.5	1.20	4.70E-2
C	K α	277.0	96.8	93.6	90.2	86.5	76.9	12.4	.822	.110	1.50E-2	7.87E-4
N	K α	392.4	93.8	87.9	82.2	76.7	65.9	43.6	10.4	1.06	.126	6.25E-3
Ti	L α	452.2	94.5	89.2	84.1	78.9	68.5	43.6	5.86	.600	7.45E-2	3.75E-3
O	K α	524.9	95.0	90.2	85.4	80.5	70.0	38.5	2.78	.319	4.13E-2	2.12E-3
Cr	L α	572.8	95.3	90.7	86.0	81.2	70.4	30.9	1.79	.219	2.90E-2	1.50E-3
F	K α	676.8	95.7	91.4	87.0	82.2	70.1	11.3	.796	.107	1.46E-2	7.68E-4
Fe	L α	705.0	95.8	91.5	87.1	82.3	69.6	8.59	.658	9.02E-2	1.24E-2	6.53E-4
Co	L α	776.2	96.0	92.0	87.8	82.9	68.3	4.67	.422	6.01E-2	8.37E-3	4.43E-4
Ni	L α	851.5	96.3	92.5	88.3	83.3	65.1	2.72	.277	4.06E-2	5.71E-3	3.04E-4
Cu	L α	929.7	96.5	92.8	88.7	83.4	56.7	1.69	.187	2.80E-2	3.97E-3	2.12E-4
Zn	L α	1011.7	96.7	93.2	89.0	83.4	32.9	1.09	.129	1.96E-2	2.80E-3	1.50E-4
Ge	L α	1188.0	97.0	93.8	89.5	82.0	7.90	.501	6.40E-2	9.99E-3	1.44E-3	7.75E-5
Mg	K α	1253.6	97.1	93.9	89.6	80.7	5.47	.390	5.08E-2	7.98E-3	1.15E-3	6.22E-5
Al	K α	1486.7	97.5	94.4	89.3	45.5	2.00	.180	2.46E-2	3.93E-3	5.72E-4	3.09E-5
Si	K α	1740.0	97.8	94.8	86.7	8.89	.887	9.01E-2	1.27E-2	2.05E-3	3.00E-4	1.62E-5
Zr	L α	2042.4	98.0	94.9	28.3	3.13	.413	4.53E-2	6.53E-3	1.06E-3	1.56E-4	8.44E-6
Nb	L α	2165.9	98.1	94.8	15.1	2.24	.316	3.53E-2	5.12E-3	8.35E-4	1.23E-4	6.65E-6
Mo	L α	2293.2	98.2	94.7	9.36	1.65	.244	2.78E-2	4.05E-3	6.61E-4	9.71E-5	5.27E-6
Cl	K α	2622.4	98.3	93.3	3.81	.839	.135	1.59E-2	2.33E-3	3.82E-4	5.63E-5	3.06E-6
Ag	L α	2984.3	98.5	38.8	1.84	.454	7.71E-2	9.28E-3	1.38E-3	2.26E-4	3.33E-5	1.81E-6
Ca	K α	3691.7	98.6	5.51	.636	.174	3.14E-2	3.88E-3	5.80E-4	9.55E-5	1.41E-5	7.66E-7
Ti	K α	4510.8	98.6	1.73	.254	7.35E-2	1.37E-2	1.71E-3	2.58E-4	4.25E-5	6.28E-6	3.42E-7
V	K α	4952.2	98.5	1.08	.168	4.95E-2	9.30E-3	1.17E-3	1.77E-4	2.92E-5	4.31E-6	2.34E-7
Cr	K α	5414.7	98.0	.699	.114	3.41E-2	6.45E-3	8.17E-4	1.23E-4	2.04E-5	3.01E-6	1.64E-7
Mn	K α	5898.8	43.9	.468	7.93E-2	2.39E-2	4.55E-3	5.78E-4	8.73E-5	1.44E-5	2.13E-6	1.16E-7
Co	K α	6930.3	8.27	.226	4.02E-2	1.23E-2	2.36E-3	3.02E-4	4.56E-5	7.55E-6	1.12E-6	6.07E-8
Ni	K α	7478.2	4.95	.162	2.93E-2	8.99E-3	1.74E-3	2.22E-4	3.36E-5	5.56E-6	8.22E-7	4.47E-8
Cu	K α	8047.8	3.18	.118	2.16E-2	6.66E-3	1.29E-3	1.65E-4	2.50E-5	4.14E-6	6.12E-7	3.33E-8
Ge	K α	9886.4	1.07	4.94E-2	9.28E-3	2.89E-3	5.63E-4	7.23E-5	1.10E-5	1.82E-6	2.68E-7	1.46E-8

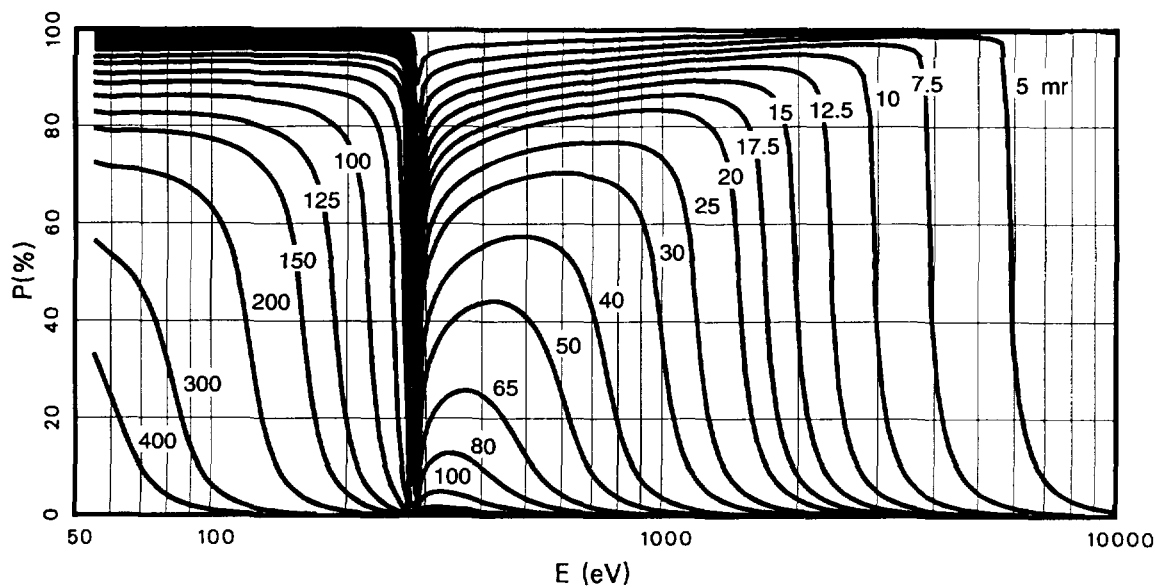

TABLE III. Specular Reflectivity for Mirrors
See page 211 for Explanation of Tables

Aluminum (Al)
 $\rho = 2.70 \text{ gm/cm}^3$

		Grazing Incidence Angle, θ (milliradians)										
Line	E(eV)	5 mr	10 mr	15 mr	20 mr	30 mr	50 mr	80 mr	125 mr	200 mr	400 mr	
Al	L _{2,3}	72.4	92.5	85.5	79.1	73.1	62.6	45.9	29.1	15.0	5.47	.630
Si	L _{2,3}	91.5	94.0	88.4	83.0	78.0	68.9	53.7	36.6	20.3	7.34	.659
Be	K	108.5	94.4	89.0	84.0	79.3	70.5	55.7	38.7	21.8	7.70	.615
Zr	M ζ	151.1	95.2	90.7	86.3	82.2	74.4	60.7	43.8	24.8	7.40	.390
B	K α	183.3	95.7	91.6	87.6	83.8	76.6	63.5	46.5	25.5	5.69	.233
C	K α	277.0	96.3	92.7	89.2	85.8	79.2	66.2	45.7	12.5	1.06	4.40E-2
N	K α	392.4	96.8	93.6	90.5	87.3	81.0	66.5	28.3	1.95	.208	9.91E-3
Ti	L α	452.2	96.9	93.8	90.8	87.7	81.2	64.7	12.2	.950	.111	5.48E-3
O	K α	524.9	97.1	94.2	91.2	88.2	81.6	60.8	4.58	.463	5.81E-2	2.94E-3
Cr	L α	572.8	97.2	94.4	91.5	88.5	81.8	55.2	2.74	.308	3.98E-2	2.04E-3
F	K α	676.8	97.4	94.9	92.2	89.2	81.9	21.6	1.11	.143	1.93E-2	1.01E-3
Co	L α	776.2	97.6	95.1	92.5	89.5	80.8	6.99	.558	7.75E-2	1.07E-2	5.64E-4
Ni	L α	851.5	97.7	95.4	92.8	89.7	79.1	3.78	.357	5.13E-2	7.18E-3	3.81E-4
Cu	L α	929.7	97.8	95.5	92.9	89.7	75.2	2.24	.235	3.48E-2	4.91E-3	2.62E-4
Zn	L α	1011.7	97.9	95.7	93.1	89.6	60.9	1.39	.158	2.39E-2	3.40E-3	1.82E-4
Mg	K α	1253.6	98.1	95.9	93.0	87.3	6.62	.444	5.73E-2	8.97E-3	1.30E-3	6.97E-5
Al	K α	1486.7	97.8	95.2	90.2	26.9	1.62	.151	2.09E-2	3.35E-3	4.88E-4	2.64E-5
Si	K α	1740.0	83.9	66.8	42.9	11.7	1.21	.121	1.69E-2	2.72E-3	3.97E-4	2.15E-5
Zr	L α	2042.4	86.5	70.4	38.2	5.88	.692	7.28E-2	1.04E-2	1.68E-3	2.46E-4	1.33E-5
Cl	K α	2622.4	88.6	70.0	8.95	1.64	.243	2.78E-2	4.05E-3	6.61E-4	3.71E-5	5.27E-6
Ag	L α	2984.3	89.3	64.7	3.99	.875	.140	1.65E-2	2.43E-3	3.97E-4	5.85E-5	3.17E-6
Ca	K α	3691.7	90.3	15.8	1.27	.328	5.69E-2	6.93E-3	1.03E-3	1.69E-4	2.50E-5	1.36E-6
Ti	K α	4510.8	90.6	3.81	.483	.135	2.46E-2	3.05E-3	4.57E-4	7.54E-5	1.11E-5	6.05E-7
V	K α	4952.2	90.4	2.24	.315	9.02E-2	1.66E-2	2.08E-3	3.13E-4	5.16E-5	7.62E-6	4.14E-7
Cr	K α	5414.7	89.8	1.40	.211	6.16E-2	1.15E-2	1.45E-3	2.18E-4	3.59E-5	5.31E-6	2.88E-7
Mn	K α	5898.8	88.2	.909	.145	4.28E-2	8.07E-3	1.02E-3	1.54E-4	2.54E-5	3.75E-6	2.04E-7
Co	K α	6930.3	30.3	.423	7.22E-2	2.18E-2	4.16E-3	5.29E-4	7.99E-5	1.32E-5	1.95E-6	1.06E-7
Ni	K α	7478.2	13.5	.299	5.22E-2	1.59E-2	3.05E-3	3.88E-4	5.87E-5	9.71E-6	1.43E-6	7.81E-8
Cu	K α	8047.8	7.61	.215	3.83E-2	1.17E-2	2.26E-3	2.88E-4	4.36E-5	7.21E-6	1.07E-6	5.80E-8
Ge	K α	9886.4	2.17	8.79E-2	1.62E-2	5.03E-3	9.77E-4	1.25E-4	1.90E-5	3.14E-6	4.64E-7	2.53E-8
Y	K α	14988.0	.289	1.54E-2	2.95E-3	9.26E-4	1.81E-4	2.34E-5	3.55E-6	5.87E-7	3.68E-8	4.71E-9
Mo	K α	17479.0	.147	8.18E-3	1.58E-3	4.97E-4	9.77E-5	1.26E-5	1.91E-6	3.16E-7	4.68E-8	2.55E-9
Pd	K α	21177.0	6.46E-2	3.74E-3	7.29E-4	2.29E-4	4.51E-5	5.83E-6	8.84E-7	1.47E-7	2.16E-8	1.18E-9
Sn	K α	25271.0	3.08E-2	1.83E-3	3.57E-4	1.13E-4	2.22E-5	2.87E-6	4.35E-7	7.20E-8	1.06E-8	0.
Xe	K α	29779.0	1.56E-2	9.42E-4	1.85E-4	5.83E-5	1.15E-5	1.48E-6	2.25E-7	3.74E-8	5.52E-9	0.

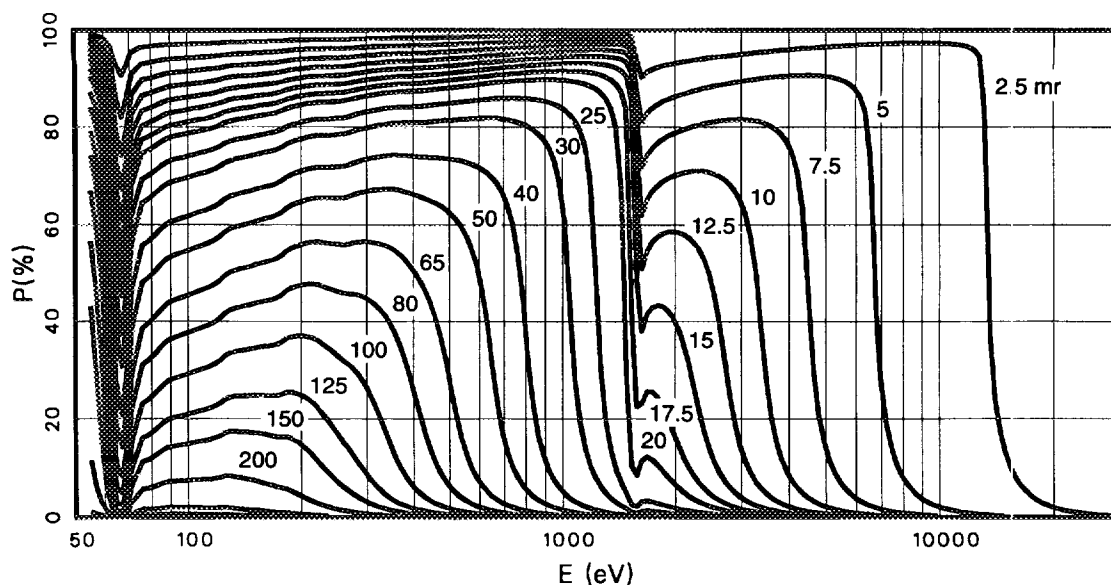

TABLE III. Specular Reflectivity for Mirrors
See page 211 for Explanation of Tables

Aluminum Oxide (Al₂O₃)
ρ = 3.96 gm/cm³

Grazing Incidence Angle, θ (milliradians)

Line	E(eV)	5 mr	10 mr	15 mr	20 mr	30 mr	50 mr	80 mr	125 mr	200 mr	400 mr
Al L _{2,3}	72.4	96.8	93.7	90.7	87.8	82.3	72.0	58.6	41.9	21.1	1.81
Si L _{2,3}	91.5	97.3	94.6	92.0	89.5	84.6	75.6	63.5	47.9	27.3	2.93
Be K	108.5	97.2	94.4	91.7	89.1	84.0	74.7	62.1	45.9	24.4	1.99
Zr M _ζ	151.1	97.3	94.6	92.0	89.4	84.5	75.3	62.6	45.2	19.8	.858
B K _α	183.3	97.4	94.9	92.5	90.1	85.5	76.6	64.0	45.4	15.1	.461
C K _α	277.0	97.8	95.7	93.6	91.5	87.3	79.0	65.1	33.3	2.26	8.09E-2
N K _α	392.4	98.0	96.1	94.2	92.3	88.3	79.4	56.9	4.25	.384	1.74E-2
Ti L _α	452.2	98.1	96.1	94.2	92.2	88.1	78.0	35.6	1.77	.190	9.04E-3
O K _α	524.9	97.7	95.5	93.2	90.9	85.7	70.1	6.44	.590	7.24E-2	3.63E-3
Cr L _α	572.8	94.1	88.4	82.9	77.5	66.4	40.6	5.35	.564	7.06E-2	3.57E-3
F K _α	676.8	95.4	91.0	86.5	82.0	72.2	42.5	3.08	.345	4.44E-2	2.27E-3
Co L _α	776.2	95.9	91.8	87.7	83.3	73.3	30.6	1.61	.199	2.64E-2	1.37E-3
Ni L _α	851.5	96.1	92.3	88.3	84.1	73.6	17.2	1.03	.135	1.82E-2	9.52E-4
Cu L _α	929.7	96.3	92.6	88.7	84.5	73.1	9.12	.679	9.27E-2	1.27E-2	6.70E-4
Zn L _α	1011.7	96.5	93.0	89.2	84.9	72.0	5.22	.457	6.46E-2	8.98E-3	4.75E-4
Mg K _α	1253.6	96.9	93.6	89.8	84.9	55.0	1.50	.169	2.54E-2	3.61E-3	1.93E-4
Al K _α	1486.7	96.9	93.5	89.2	82.0	9.36	.559	7.07E-2	1.10E-2	1.59E-3	8.52E-5
Si K _α	1740.0	91.8	83.0	71.7	51.6	4.28	.333	4.40E-2	6.94E-3	1.01E-3	5.43E-5
Zr L _α	2042.4	92.8	84.6	72.0	31.8	1.98	.180	2.46E-2	3.93E-3	5.73E-4	3.09E-5
Cl K _α	2622.4	93.9	85.6	55.1	5.09	.604	6.41E-2	9.14E-3	1.48E-3	2.17E-4	1.18E-5
Ag L _α	2984.3	94.4	85.4	16.7	2.41	.335	3.74E-2	5.42E-3	8.82E-4	1.30E-4	7.03E-6
Ca K _α	3691.7	95.0	80.7	3.68	.815	.131	1.55E-2	2.28E-3	3.74E-4	5.50E-5	2.99E-6
Ti K _α	4510.8	95.5	15.4	1.24	.320	5.57E-2	6.78E-3	1.01E-3	1.66E-4	2.44E-5	1.33E-6
V K _α	4952.2	95.6	7.35	.781	.211	3.75E-2	4.62E-3	6.90E-4	1.14E-4	1.68E-5	9.11E-7
Cr K _α	5414.7	95.7	4.11	.511	.142	2.58E-2	3.20E-3	4.80E-4	7.91E-5	1.17E-5	6.34E-7
Mn K _α	5898.8	95.6	2.50	.345	9.82E-2	1.81E-2	2.26E-3	3.39E-4	5.59E-5	8.25E-6	4.49E-7
Co K _α	6930.3	95.0	1.08	.168	4.94E-2	9.29E-3	1.17E-3	1.76E-4	2.91E-5	4.30E-6	2.34E-7
Ni K _α	7478.2	93.7	.742	.121	3.59E-2	6.79E-3	8.60E-4	1.30E-4	2.14E-5	3.16E-6	1.72E-7
Cu K _α	8047.8	79.9	.524	8.80E-2	2.64E-2	5.03E-3	6.39E-4	9.64E-5	1.59E-5	2.35E-6	1.28E-7
Ge K _α	9886.4	7.14	.207	3.69E-2	1.13E-2	2.17E-3	2.78E-4	4.20E-5	6.95E-6	1.03E-6	5.59E-8
Y K _α	14988.0	.720	3.50E-2	6.63E-3	2.07E-3	4.04E-4	5.19E-5	7.87E-6	1.30E-6	1.93E-7	1.05E-8
Mo K _α	17479.0	.353	1.85E-2	3.54E-3	1.11E-3	2.17E-4	2.80E-5	4.25E-6	7.03E-7	1.04E-7	5.65E-9
Pd K _α	21177.0	.151	8.42E-3	1.63E-3	5.12E-4	1.00E-4	1.30E-5	1.97E-6	3.25E-7	4.81E-8	2.61E-9
Sn K _α	25271.0	7.10E-2	4.10E-3	7.98E-4	2.51E-4	4.94E-5	6.38E-6	9.68E-7	1.60E-7	2.37E-8	1.29E-9
Xe K _α	29779.0	3.57E-2	2.11E-3	4.12E-4	1.30E-4	2.56E-5	3.30E-6	5.01E-7	8.30E-8	1.23E-8	0.

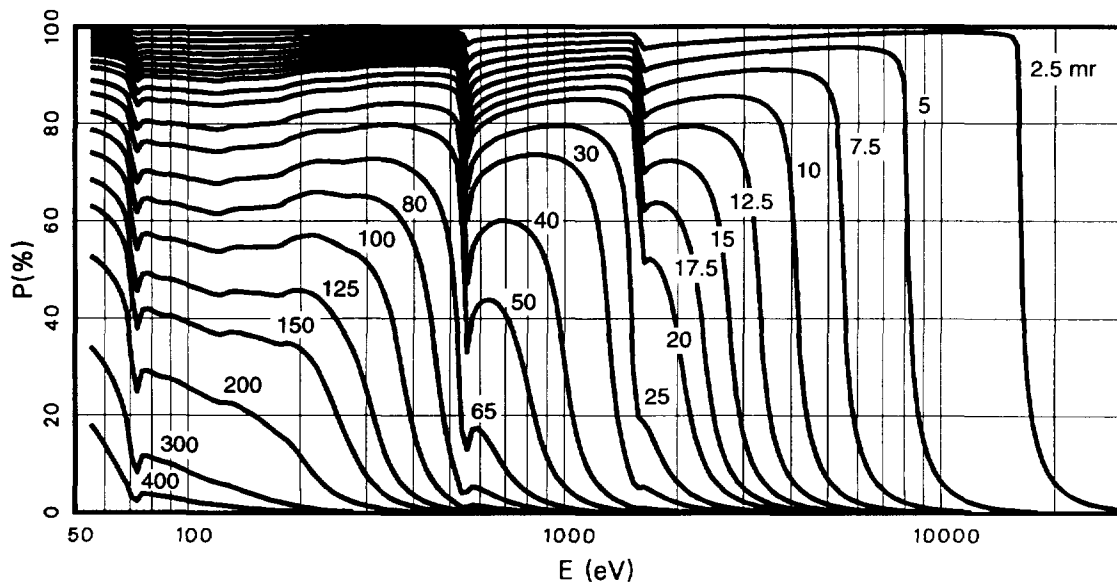

TABLE III. Specular Reflectivity for Mirrors
See page 211 for Explanation of Tables

Quartz (SiO₂)
 $\rho = 2.20 \text{ gm/cm}^3$

		Grazing Incidence Angle, θ (milliradians)										
Line	E(eV)	5 mr	10 mr	15 mr	20 mr	30 mr	50 mr	80 mr	125 mr	200 mr	400 mr	
Al	L _{2,3}	72.4	98.4	96.8	95.2	93.6	90.6	84.7	78.2	63.9	42.8	2.93
Si	L _{2,3}	91.5	98.0	96.1	94.2	92.3	88.7	81.6	71.3	55.7	25.7	.733
Be	K	108.5	96.6	93.3	90.1	87.0	81.1	70.1	55.0	34.7	9.48	.348
Zr	M ζ	151.1	96.3	92.7	89.2	85.9	79.4	67.4	51.0	28.5	5.25	.191
B	K α	183.3	96.4	92.9	89.5	86.2	79.9	67.9	50.7	25.2	3.19	.117
C	K α	277.0	97.0	94.1	91.2	88.4	82.7	70.7	47.3	6.02	.522	2.31E-2
N	K α	392.4	97.3	94.6	91.9	89.1	83.3	67.9	11.7	.906	.107	5.25E-3
Ti	L α	452.2	97.3	94.5	91.8	88.9	82.5	61.6	4.15	.428	5.40E-2	2.74E-3
O	K α	524.9	96.7	93.3	89.9	86.2	77.2	22.7	1.19	.153	2.05E-2	1.07E-3
Cr	L α	572.8	91.4	83.3	75.5	67.7	51.4	14.1	1.20	.159	2.15E-2	1.12E-3
F	K α	676.8	93.4	87.0	80.6	73.8	57.8	9.39	.746	.102	1.40E-2	7.34E-4
Co	L α	776.2	94.1	88.2	82.2	75.5	57.0	4.59	.425	6.06E-2	8.45E-3	4.47E-4
Ni	L α	851.5	94.5	88.9	83.0	76.1	53.9	2.79	.285	4.17E-2	5.88E-3	3.12E-4
Cu	L α	929.7	94.7	89.4	83.4	76.2	46.5	1.77	.195	2.92E-2	4.14E-3	2.21E-4
Zn	L α	1011.7	95.0	89.8	83.8	76.0	31.0	1.16	.135	2.06E-2	2.94E-3	1.57E-4
Mg	K α	1253.6	95.5	90.6	84.2	72.3	5.91	.414	5.37E-2	8.43E-3	1.22E-3	6.56E-5
Al	K α	1486.7	95.9	91.0	83.1	43.7	2.09	.187	2.55E-2	4.07E-3	5.93E-4	3.20E-5
Si	K α	1740.0	96.0	90.8	76.8	8.14	.839	8.59E-2	1.21E-2	1.96E-3	2.87E-4	1.55E-5
Zr	L α	2042.4	89.1	74.4	26.8	3.48	.454	4.96E-2	7.13E-3	1.16E-3	1.70E-4	9.21E-6
Cl	K α	2622.4	90.8	71.4	5.02	1.05	.165	1.92E-2	2.82E-3	4.62E-4	6.79E-5	3.69E-6
Ag	L α	2984.3	91.3	54.9	2.41	.575	9.57E-2	1.14E-2	1.69E-3	2.78E-4	4.09E-5	2.22E-6
Ca	K α	3691.7	91.9	7.90	.822	.221	3.93E-2	4.83E-3	7.20E-4	1.19E-4	1.75E-5	9.51E-7
Ti	K α	4510.8	91.9	2.31	.324	9.25E-2	1.71E-2	2.13E-3	3.20E-4	5.29E-5	7.80E-6	4.24E-7
V	K α	4952.2	91.4	1.41	.213	6.21E-2	1.16E-2	1.46E-3	2.19E-4	3.63E-5	5.35E-6	2.91E-7
Cr	K α	5414.7	89.9	.903	.144	4.26E-2	8.03E-3	1.02E-3	1.53E-4	2.53E-5	3.73E-6	2.03E-7
Mn	K α	5898.8	83.7	.599	9.94E-2	2.97E-2	5.65E-3	7.17E-4	1.08E-4	1.79E-5	2.64E-6	1.44E-7
Co	K α	6930.3	12.4	.286	5.01E-2	1.52E-2	2.92E-3	3.73E-4	5.63E-5	9.32E-6	1.38E-6	7.49E-8
Ni	K α	7478.2	6.97	.204	3.63E-2	1.11E-2	2.14E-3	2.74E-4	4.14E-5	6.85E-6	1.01E-6	5.51E-8
Cu	K α	8047.8	4.32	.148	2.67E-2	8.22E-3	1.59E-3	2.04E-4	3.08E-5	5.10E-6	7.53E-7	4.10E-8
Ge	K α	9886.4	1.38	6.11E-2	1.14E-2	3.54E-3	6.90E-4	8.87E-5	1.34E-5	2.22E-6	3.29E-7	1.79E-8
Y	K α	14988.0	.198	1.08E-2	2.09E-3	6.56E-4	1.29E-4	1.66E-5	2.52E-6	4.17E-7	6.17E-8	3.37E-9
Mo	K α	17479.0	.102	5.78E-3	1.12E-3	3.53E-4	6.94E-5	8.95E-6	1.36E-6	2.25E-7	3.33E-8	1.81E-9
Pd	K α	21177.0	4.52E-2	2.65E-3	5.18E-4	1.63E-4	3.21E-5	4.15E-6	6.29E-7	1.04E-7	1.54E-8	0.
Sn	K α	25271.0	2.17E-2	1.30E-3	2.54E-4	8.02E-5	1.58E-5	2.04E-6	3.09E-7	5.13E-8	7.61E-9	0.
Xe	K α	29779.0	1.11E-2	6.69E-4	1.31E-4	4.15E-5	8.18E-6	1.06E-6	1.61E-7	2.66E-8	3.94E-9	0.

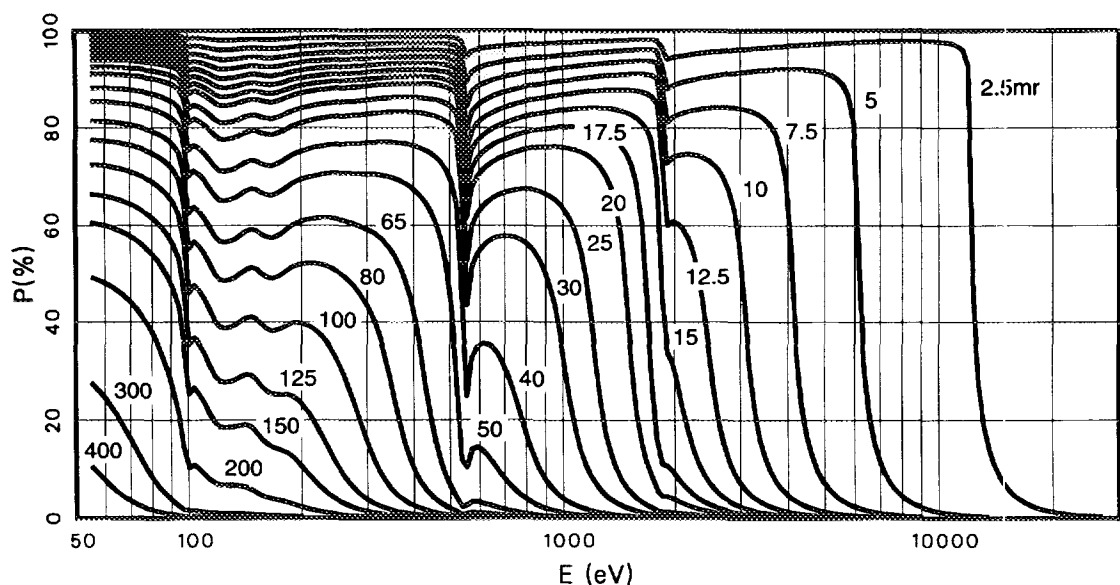

TABLE III. Specular Reflectivity for Mirrors

See page 211 for Explanation of Tables

Nickel (Ni)

$\rho = 8.90 \text{ gm/cm}^3$

Grazing Incidence Angle, θ (milliradians)

Line	E(eV)	5 mr	10 mr	15 mr	20 mr	30 mr	50 mr	80 mr	125 mr	200 mr	400 mr
Al L _{2,3}	72.4	97.3	94.7	92.2	89.7	85.0	76.3	64.7	50.3	32.4	8.18
Si L _{2,3}	91.5	97.7	95.5	93.3	91.2	87.1	79.3	68.8	55.2	36.8	8.25
Be K	108.5	97.7	95.4	93.2	91.1	86.9	79.1	68.4	54.4	35.1	5.87
Zr M ζ	151.1	97.5	95.0	92.6	90.2	85.6	77.0	65.3	49.7	27.7	2.11
B K α	183.3	97.5	95.0	92.6	90.2	85.6	77.0	65.0	48.5	23.8	1.15
C K α	277.0	97.5	95.1	92.7	90.3	85.7	76.9	63.8	42.7	8.37	.243
N K α	392.4	97.6	95.3	93.0	90.7	86.2	77.1	61.4	23.3	1.50	5.78E-2
Ti L α	452.2	97.7	95.3	93.1	90.8	86.3	76.7	58.0	10.0	.741	3.14E-2
O K α	524.9	97.7	95.4	93.1	90.9	86.2	75.9	50.5	3.84	.358	1.63E-2
Cr L α	572.8	97.7	95.4	93.2	90.9	86.2	75.1	39.9	2.23	.230	1.09E-2
F K α	676.8	97.5	95.1	92.6	90.1	84.7	69.7	9.58	.782	9.33E-2	4.63E-3
Co L α	776.2	97.0	94.0	90.9	87.7	80.3	49.4	2.32	.269	3.51E-2	1.80E-3
Ni L α	851.5	80.0	63.5	49.4	37.3	18.3	2.90	.375	5.72E-2	8.16E-3	4.37E-4
Cu L α	929.7	87.6	76.6	66.6	57.5	41.0	15.3	2.20	.301	4.06E-2	2.12E-3
Zn L α	1011.7	88.4	78.0	68.4	59.4	42.9	15.4	1.95	.261	3.52E-2	1.84E-3
Mg K α	1253.6	91.4	83.2	75.3	67.4	50.7	12.3	1.05	.140	1.91E-2	1.00E-3
Al K α	1486.7	92.3	84.9	77.5	69.6	50.2	5.60	.511	7.22E-2	1.00E-2	5.30E-4
Si K α	1740.0	93.0	86.1	78.8	70.5	44.8	2.44	.258	3.81E-2	5.37E-3	2.86E-4
Zr L α	2042.4	93.6	87.1	79.7	70.3	25.2	1.09	.129	1.96E-2	2.80E-3	1.50E-4
Cl K α	2622.4	94.4	88.2	79.9	63.2	4.35	.333	4.40E-2	6.93E-3	1.00E-3	5.42E-5
Ag L α	2984.3	94.7	88.6	78.9	39.0	2.07	.186	2.54E-2	4.05E-3	5.90E-4	3.19E-5
Ca K α	3691.7	95.3	88.9	68.4	6.23	.698	7.29E-2	1.04E-2	1.68E-3	2.45E-4	1.33E-5
Ti K α	4510.8	95.7	88.1	11.3	1.88	.272	3.08E-2	4.48E-3	7.31E-4	1.07E-4	5.83E-6
V K α	4952.2	95.8	86.6	5.69	1.15	.178	2.07E-2	3.04E-3	4.97E-4	7.30E-5	3.96E-6
Cr K α	5414.7	96.0	82.5	3.25	.736	.120	1.42E-2	2.09E-3	3.43E-4	5.04E-5	2.74E-6
Mn K α	5898.8	96.1	47.8	1.99	.486	8.20E-2	9.85E-3	1.46E-3	2.40E-4	3.53E-5	1.92E-6
Co K α	6930.3	96.2	8.24	.843	.226	4.01E-2	4.93E-3	7.35E-4	1.21E-4	1.79E-5	9.71E-7
Ni K α	7478.2	96.1	4.70	.566	.156	2.83E-2	3.50E-3	5.24E-4	8.64E-5	1.27E-5	6.93E-7
Cu K α	8047.8	95.8	2.70	.367	.104	1.91E-2	2.39E-3	3.58E-4	5.91E-5	8.72E-6	4.74E-7
Ge K α	9886.4	71.7	1.17	.182	5.33E-2	1.00E-2	1.26E-3	1.90E-4	3.14E-5	4.63E-6	2.52E-7
Y K α	14988.0	6.08	.187	3.35E-2	1.03E-2	1.98E-3	2.53E-4	3.83E-5	6.33E-6	9.36E-7	5.10E-8
Mo K α	17479.0	2.44	9.65E-2	1.78E-2	5.50E-3	1.07E-3	1.37E-4	2.07E-5	3.43E-6	5.07E-7	2.76E-8
Pd K α	21177.0	.912	4.30E-2	8.10E-3	2.52E-3	4.92E-4	6.33E-5	9.59E-6	1.59E-6	2.35E-7	1.28E-8
Sn K α	25271.0	.397	2.06E-2	3.94E-3	1.23E-3	2.41E-4	3.11E-5	4.71E-6	7.80E-7	1.15E-7	6.27E-9
Xe K α	29779.0	.191	1.05E-2	2.02E-3	6.34E-4	1.24E-4	1.60E-5	2.43E-6	4.03E-7	5.96E-8	3.22E-9

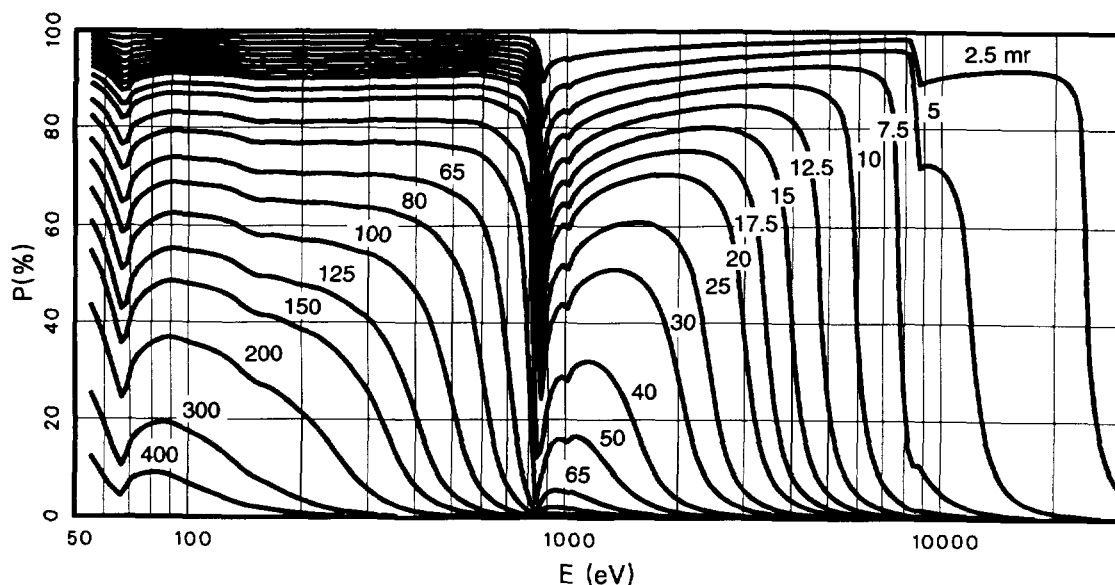

TABLE III. Specular Reflectivity for Mirrors
See page 211 for Explanation of Tables

Copper (Cu)
 $\rho = 8.96 \text{ gm/cm}^3$

		Grazing Incidence Angle, θ (milliradians)										
Line	E(eV)	5 mr	10 mr	15 mr	20 mr	30 mr	50 mr	80 mr	125 mr	200 mr	400 mr	
Al	L _{2,3}	72.4	97.6	95.3	93.0	90.8	86.5	78.5	67.7	53.9	35.7	8.51
Si	L _{2,3}	91.5	97.3	94.7	92.2	89.7	85.0	76.2	64.5	49.6	30.5	5.23
Be	K	108.5	97.2	94.4	91.7	89.1	84.1	74.8	62.5	47.0	27.3	3.74
Zr	M ζ	151.1	97.1	94.3	91.6	89.0	83.9	74.4	61.8	45.6	24.0	1.96
B	K α	183.3	97.2	94.6	91.9	89.4	84.5	75.2	62.6	45.7	21.7	1.13
C	K α	277.0	97.3	94.8	92.2	89.7	84.9	75.6	61.9	40.3	7.49	.226
N	K α	392.4	97.4	94.8	92.2	89.7	84.8	74.7	57.8	20.0	1.38	5.40E-2
Ti	L α	452.2	97.4	94.9	92.4	89.9	84.9	74.5	54.5	9.01	.696	2.98E-2
O	K α	524.9	97.3	94.7	92.2	89.6	84.4	72.8	45.3	3.58	.341	1.56E-2
Cr	L α	572.8	97.3	94.7	92.1	89.5	84.1	71.6	35.2	2.16	.226	1.07E-2
F	K α	676.8	97.3	94.6	91.9	89.2	83.3	67.7	10.4	.837	9.92E-2	4.91E-3
Co	L α	776.2	96.9	93.9	90.8	87.7	80.6	55.8	3.30	.359	4.59E-2	2.34E-3
Ni	L α	851.5	96.3	92.6	88.8	84.7	75.2	25.9	1.34	.169	2.26E-2	1.18E-3
Cu	L α	929.7	71.4	50.7	35.7	24.8	11.6	2.62	.452	7.64E-2	1.13E-2	6.18E-4
Zn	L α	1011.7	87.0	75.5	65.0	55.4	38.1	11.9	1.50	.209	2.85E-2	1.49E-3
Mg	K α	1253.6	89.8	80.3	71.2	62.3	44.0	9.37	.880	.121	1.66E-2	8.74E-4
Al	K α	1486.7	91.2	82.9	74.5	65.8	44.9	4.80	.460	6.57E-2	6.16E-3	4.85E-4
Si	K α	1740.0	92.1	84.3	76.1	66.9	39.1	2.19	.237	3.51E-2	4.97E-3	2.65E-4
Zr	L α	2042.4	92.8	85.4	77.2	66.6	21.0	.996	.119	1.83E-2	2.61E-3	1.40E-4
Cl	K α	2622.4	93.7	86.7	77.3	58.1	3.94	.310	4.11E-2	6.50E-3	9.42E-4	5.08E-5
Ag	L α	2984.3	94.1	87.2	76.1	32.1	1.90	.173	2.38E-2	3.80E-3	5.53E-4	2.99E-5
Ca	K α	3691.7	94.7	87.4	62.3	5.62	.648	6.82E-2	9.72E-3	1.57E-3	2.30E-4	1.25E-5
Ti	K α	4510.8	95.1	86.4	9.99	1.73	.254	2.89E-2	4.21E-3	6.87E-4	1.01E-4	5.48E-6
V	K α	4952.2	95.3	84.5	5.15	1.07	.167	1.94E-2	2.85E-3	4.67E-4	6.87E-5	3.73E-6
Cr	K α	5414.7	95.5	78.9	2.98	.685	.112	1.33E-2	1.97E-3	3.23E-4	4.75E-5	2.58E-6
Mn	K α	5898.8	95.6	37.2	1.84	.454	7.71E-2	9.28E-3	1.38E-3	2.26E-4	3.33E-5	1.81E-6
Co	K α	6930.3	95.7	7.54	.794	.214	3.81E-2	4.68E-3	6.99E-4	1.15E-4	1.70E-5	9.23E-7
Ni	K α	7478.2	95.7	4.44	.542	.150	2.72E-2	3.37E-3	5.05E-4	8.32E-5	1.23E-5	6.68E-7
Cu	K α	8047.8	95.5	2.76	.374	.106	1.95E-2	2.43E-3	3.64E-4	6.01E-5	8.87E-6	4.83E-7
Ge	K α	9886.4	66.5	1.01	.160	4.72E-2	8.87E-3	1.12E-3	1.69E-4	2.79E-5	4.12E-6	2.24E-7
Y	K α	14988.0	5.35	.171	3.09E-2	9.47E-3	1.83E-3	2.34E-4	3.54E-5	5.85E-6	8.65E-7	4.71E-8
Mo	K α	17479.0	2.20	8.90E-2	1.64E-2	5.09E-3	9.88E-4	1.27E-4	1.92E-5	3.18E-6	4.70E-7	2.55E-8
Pd	K α	21177.0	.833	3.97E-2	7.51E-3	2.34E-3	4.57E-4	5.87E-5	8.90E-6	1.47E-6	2.18E-7	1.19E-8
Sn	K α	25271.0	.365	1.91E-2	3.65E-3	1.14E-3	2.24E-4	2.88E-5	4.37E-6	7.24E-7	1.07E-7	5.86E-9
Xe	K α	29779.0	.176	9.70E-3	1.87E-3	5.88E-4	1.16E-4	1.49E-5	2.26E-6	3.74E-7	5.53E-8	3.00E-9

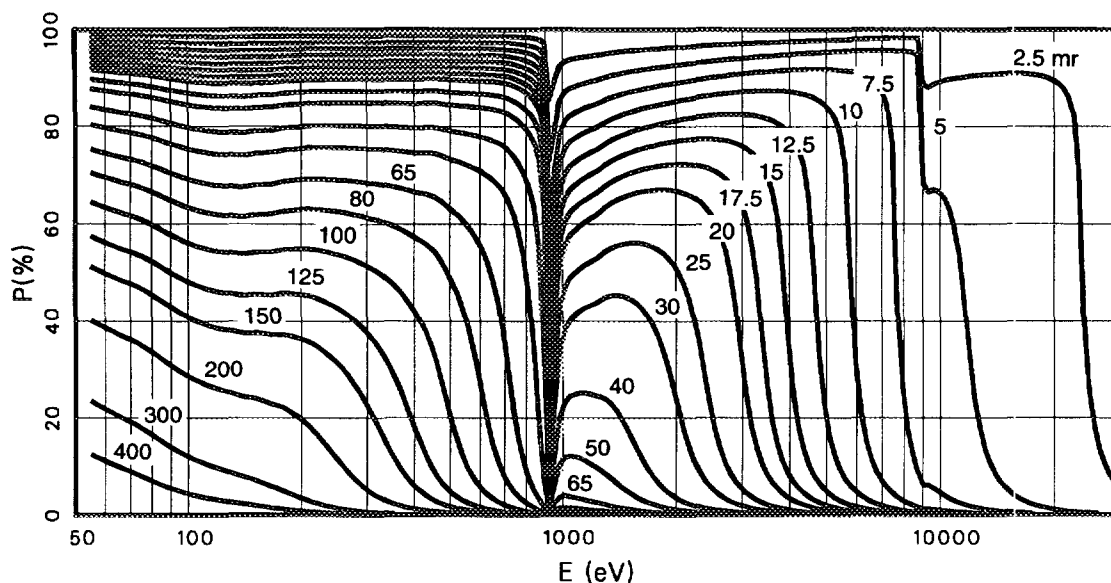

TABLE III. Specular Reflectivity for Mirrors

See page 211 for Explanation of Tables

Molybdenum (Mo)

 $\rho = 10.20 \text{ gm/cm}^3$ Grazing Incidence Angle, θ (milliradians)

Line	E(eV)	5 mr	10 mr	15 mr	20 mr	30 mr	50 mr	80 mr	125 mr	200 mr	400 mr	
Al	L _{2,3}	72.4	99.5	99.1	98.6	98.2	97.3	95.5	92.8	88.8	82.0	58.6
Si	L _{2,3}	91.5	99.7	99.5	99.2	99.0	98.5	97.4	95.9	93.4	88.7	40.0
Be	K	108.5	99.7	99.5	99.2	98.9	98.4	97.4	95.7	93.1	87.3	5.22
Zr	M ζ	151.1	99.2	98.4	97.5	96.7	95.1	91.8	86.6	77.3	40.9	.535
B	K α	183.3	98.6	97.1	95.7	94.3	91.5	85.9	76.8	58.0	6.57	.176
C	K α	277.0	91.2	83.2	75.9	69.1	57.2	38.5	19.8	6.33	1.07	5.60E-2
N	K α	392.4	92.5	85.5	79.0	73.0	62.0	43.7	23.4	6.97	.999	4.81E-2
Ti	L α	452.2	93.0	86.5	80.4	74.7	64.1	45.9	24.3	6.21	.779	3.65E-2
O	K α	524.9	93.4	87.1	81.3	75.7	65.3	46.8	23.3	4.59	.525	2.45E-2
Cr	L α	572.8	93.8	87.9	82.3	76.9	66.8	48.2	22.8	3.64	.402	1.89E-2
F	K α	676.8	94.1	88.5	83.1	77.9	67.8	47.7	16.9	1.81	.206	9.96E-3
Co	L α	776.2	94.2	88.7	83.3	78.1	67.8	45.7	10.4	1.02	.121	6.00E-3
Ni	L α	851.5	94.5	89.2	84.0	78.9	68.5	44.6	6.85	.685	8.42E-2	4.22E-3
Cu	L α	929.7	94.6	89.5	84.4	79.3	68.7	41.7	4.28	.460	5.82E-2	2.95E-3
Zn	L α	1011.7	94.7	89.6	84.5	79.3	68.3	36.3	2.71	.314	4.07E-2	2.09E-3
Mg	K α	1253.6	95.0	90.1	85.0	79.7	66.8	13.5	.920	.122	1.66E-2	8.71E-4
Al	K α	1486.7	95.2	90.4	85.3	79.5	62.7	4.37	.404	5.78E-2	8.06E-3	4.27E-4
Si	K α	1740.0	95.3	90.6	85.2	78.7	49.6	1.74	.192	2.87E-2	4.08E-3	2.18E-4
Zr	L α	2042.4	95.4	90.5	84.6	75.8	13.8	.717	8.86E-2	1.37E-2	1.97E-3	1.06E-4
Cl	K α	2622.4	79.6	60.2	38.8	15.7	1.85	.179	2.47E-2	3.96E-3	5.78E-4	3.13E-5
Ag	L α	2984.3	82.2	64.6	43.1	16.2	1.72	.165	2.28E-2	3.66E-3	5.34E-4	2.89E-5
Ca	K α	3691.7	85.5	68.9	38.9	6.71	.771	8.03E-2	1.14E-2	1.84E-3	2.70E-4	1.46E-5
Ti	K α	4510.8	87.1	68.7	14.1	2.29	.323	3.62E-2	5.26E-3	8.56E-4	1.26E-4	6.82E-6
V	K α	4952.2	87.7	66.9	7.37	1.42	.215	2.48E-2	3.62E-3	5.92E-4	8.70E-5	4.72E-6
Cr	K α	5414.7	88.2	62.6	4.22	.918	.146	1.72E-2	2.53E-3	4.14E-4	6.09E-5	3.31E-6
Mn	K α	5898.8	88.6	51.1	2.58	.610	.101	1.21E-2	1.78E-3	2.93E-4	4.31E-5	2.34E-6
Co	K α	6930.3	89.0	12.5	1.11	.291	5.09E-2	6.21E-3	9.25E-4	1.52E-4	2.24E-5	1.22E-6
Ni	K α	7478.2	89.2	7.09	.765	.207	3.69E-2	4.54E-3	6.78E-4	1.12E-4	1.65E-5	8.95E-7
Cu	K α	8047.8	89.2	4.39	.539	.149	2.71E-2	3.36E-3	5.02E-4	8.28E-5	1.22E-5	6.64E-7
Ge	K α	9886.4	87.9	1.39	.210	6.12E-2	1.14E-2	1.44E-3	2.17E-4	3.58E-5	5.28E-6	2.87E-7
Y	K α	14988.0	6.35	.192	3.44E-2	1.05E-2	2.03E-3	2.59E-4	3.92E-5	6.49E-6	9.59E-7	5.21E-8
Mo	K α	17479.0	2.43	9.60E-2	1.77E-2	5.47E-3	1.06E-3	1.36E-4	2.06E-5	3.41E-6	5.04E-7	2.74E-8
Pd	K α	21177.0	.894	4.23E-2	7.98E-3	2.48E-3	4.85E-4	6.24E-5	9.45E-6	1.57E-6	2.31E-7	1.26E-8
Sn	K α	25271.0	.427	2.20E-2	4.20E-3	1.31E-3	2.57E-4	3.31E-5	5.02E-6	8.32E-7	1.23E-7	6.71E-9
Xe	K α	29779.0	.210	1.14E-2	2.21E-3	6.92E-4	1.36E-4	1.75E-5	2.66E-6	4.40E-7	6.51E-8	3.53E-9

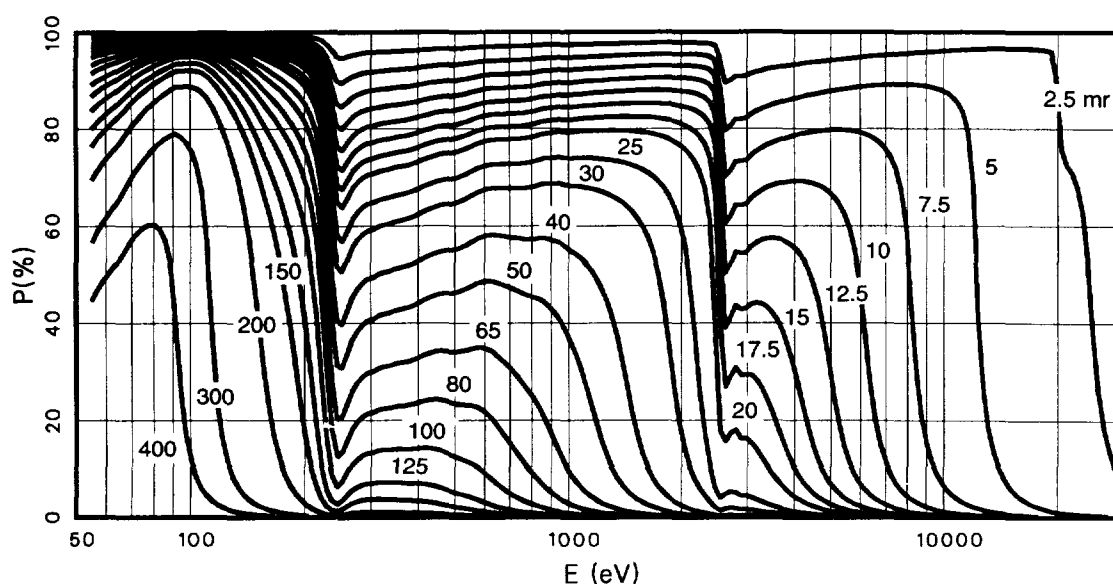

TABLE III. Specular Reflectivity for Mirrors
See page 211 for Explanation of Tables

Platinum (Pt)
 $\rho = 21.40 \text{ gm/cm}^3$

		Grazing Incidence Angle, θ (milliradians)										
Line	E(eV)	5 mr	10 mr	15 mr	20 mr	30 mr	50 mr	80 mr	125 mr	200 mr	400 mr	
Al	$L_{2,3}$	72.4	98.3	96.6	94.9	93.2	90.0	83.9	75.5	64.2	48.5	20.1
Si	$L_{2,3}$	91.5	98.9	97.9	96.8	95.8	93.7	89.7	83.9	75.7	62.6	28.1
Be	K	108.5	99.0	98.0	97.0	96.0	94.1	90.3	84.7	76.5	62.6	15.4
Zr	$M\zeta$	151.1	98.0	96.0	94.1	92.1	88.4	81.2	70.9	55.7	28.5	.999
B	$K\alpha$	183.3	96.2	92.6	89.1	85.8	79.3	67.6	52.1	32.4	9.87	.419
C	$K\alpha$	277.0	94.9	90.0	85.4	81.0	72.8	58.3	40.4	20.5	4.58	.211
N	$K\alpha$	392.4	94.3	89.0	83.9	79.0	70.0	54.3	34.9	14.2	2.25	.100
Ti	$L\alpha$	452.2	94.4	89.0	84.0	79.1	70.1	54.1	33.7	11.8	1.56	6.81E-2
O	$K\alpha$	524.9	94.1	88.5	83.1	78.1	68.6	51.6	29.7	7.95	.919	4.13E-2
Cr	$L\alpha$	572.8	93.9	88.2	82.8	77.6	67.9	50.5	27.9	6.60	.746	3.39E-2
F	$K\alpha$	676.8	94.1	88.5	83.1	78.0	68.2	50.1	24.7	4.00	.432	2.01E-2
Co	$L\alpha$	776.2	93.9	88.2	82.7	77.4	67.3	47.9	19.5	2.40	.268	1.28E-2
Ni	$L\alpha$	851.5	94.1	88.4	83.0	77.8	67.7	47.4	15.9	1.68	.192	9.31E-3
Cu	$L\alpha$	929.7	94.1	88.6	83.2	77.9	67.6	46.1	11.8	1.16	.137	6.73E-3
Zn	$L\alpha$	1011.7	94.2	88.6	83.3	78.0	67.5	44.2	8.07	.803	9.77E-2	4.87E-3
Mg	$K\alpha$	1253.6	94.3	88.7	83.3	77.8	66.1	33.6	2.64	.308	4.01E-2	2.06E-3
Al	$K\alpha$	1486.7	94.2	88.5	82.8	76.9	63.1	15.6	1.07	.141	1.90E-2	9.94E-4
Si	$K\alpha$	1740.0	93.8	87.8	81.5	74.6	56.3	4.99	.455	6.46E-2	8.99E-3	4.76E-4
Zr	$L\alpha$	2042.4	91.6	83.1	74.0	62.8	22.5	1.12	.133	2.03E-2	2.90E-3	1.56E-4
Cl	$K\alpha$	2622.4	83.1	67.9	53.2	38.1	10.8	.854	.108	1.67E-2	2.41E-3	1.29E-4
Ag	$L\alpha$	2984.3	85.0	71.0	56.6	40.3	8.92	.660	8.41E-2	1.31E-2	1.89E-3	1.02E-4
Ca	$K\alpha$	3691.7	86.3	72.7	56.6	33.7	3.61	.302	4.04E-2	6.40E-3	9.29E-4	5.01E-5
Ti	$K\alpha$	4510.8	87.6	73.9	53.0	14.7	1.35	.131	1.82E-2	2.93E-3	4.28E-4	2.31E-5
V	$K\alpha$	4952.2	88.1	74.0	47.3	7.95	.858	8.81E-2	1.25E-2	2.01E-3	2.94E-4	1.59E-5
Cr	$K\alpha$	5414.7	88.5	73.8	35.4	4.56	.564	6.04E-2	8.64E-3	1.40E-3	2.05E-4	1.11E-5
Mn	$K\alpha$	5898.8	88.8	73.0	19.2	2.78	.379	4.20E-2	6.06E-3	9.87E-4	1.45E-4	7.85E-6
Co	$K\alpha$	6930.3	89.3	68.8	5.81	1.18	.183	2.12E-2	3.11E-3	5.08E-4	7.47E-5	4.06E-6
Ni	$K\alpha$	7478.2	89.5	63.3	3.61	.806	.130	1.54E-2	2.26E-3	3.71E-4	5.46E-5	2.96E-6
Cu	$K\alpha$	8047.8	89.6	48.9	2.35	.564	9.41E-2	1.13E-2	1.66E-3	2.73E-4	4.02E-5	2.19E-6
Ge	$K\alpha$	9886.4	89.5	7.36	.785	.212	3.77E-2	4.64E-3	6.93E-4	1.14E-4	1.68E-5	9.15E-7
Y	$K\alpha$	14988.0	56.2	.811	.131	3.89E-2	7.36E-3	9.31E-4	1.40E-4	2.32E-5	3.43E-6	1.86E-7
Mo	$K\alpha$	17479.0	25.7	.420	7.18E-2	2.17E-2	4.14E-3	5.27E-4	7.95E-5	1.31E-5	1.94E-6	1.06E-7
Pd	$K\alpha$	21177.0	5.87	.183	3.29E-2	1.01E-2	1.94E-3	2.49E-4	3.76E-5	6.22E-6	9.20E-7	5.00E-8
Sn	$K\alpha$	25271.0	2.11	8.61E-2	1.59E-2	4.93E-3	9.58E-4	1.23E-4	1.86E-5	3.08E-6	4.55E-7	2.47E-8
Xe	$K\alpha$	29779.0	.915	4.31E-2	8.13E-3	2.53E-3	4.94E-4	6.35E-5	9.62E-6	1.59E-6	2.36E-7	1.28E-8

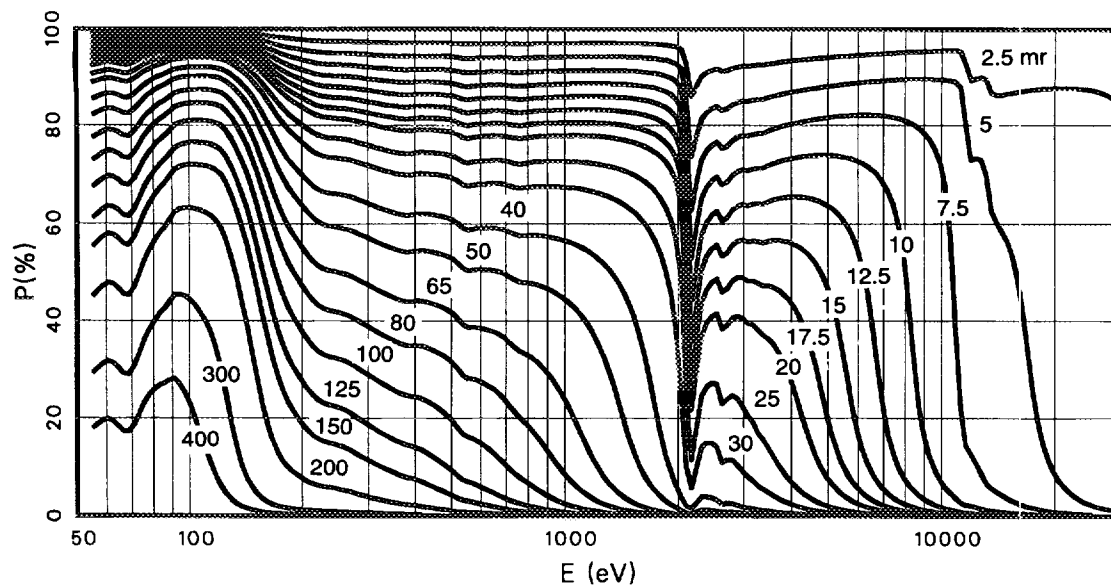

TABLE III. Specular Reflectivity for Mirrors

See page 211 for Explanation of Tables

Gold (Au)

$\rho = 19.30 \text{ gm/cm}^3$

Grazing Incidence Angle, θ (milliradians)

Line	E(eV)	5 mr	10 mr	15 mr	20 mr	30 mr	50 mr	80 mr	125 mr	200 mr	400 mr	
Al	L _{2,3}	72.4	98.7	97.5	96.3	95.0	92.6	88.0	81.5	72.3	58.6	28.1
Si	L _{2,3}	91.5	98.9	97.7	96.6	95.5	93.4	89.1	83.1	74.4	60.7	24.1
Be	K	108.5	99.0	98.0	96.9	95.9	94.0	90.1	84.5	76.2	62.1	14.6
Zr	M ζ	151.1	98.7	97.4	96.0	94.8	92.2	87.2	79.7	68.0	42.7	1.19
B	K α	183.3	97.0	94.0	91.1	88.3	82.9	72.8	58.7	38.8	11.1	.376
C	K α	277.0	94.9	90.0	85.4	81.0	72.7	58.0	39.6	18.8	3.50	.152
N	K α	392.4	94.2	88.7	83.6	78.6	69.4	53.2	33.0	11.7	1.58	7.00E-2
Ti	L α	452.2	93.9	88.2	82.8	77.7	68.1	51.2	29.9	8.76	1.07	4.83E-2
O	K α	524.9	93.8	87.9	82.3	77.0	67.1	49.5	26.8	6.20	.708	3.24E-2
Cr	L α	572.8	93.7	87.7	82.0	76.6	66.5	48.3	24.6	4.82	.540	2.51E-2
F	K α	676.8	93.5	87.4	81.6	76.0	65.5	46.1	19.9	2.86	.322	1.53E-2
Co	L α	776.2	93.5	87.4	81.5	75.9	65.2	44.5	15.3	1.77	.205	9.95E-3
Ni	L α	851.5	93.5	87.4	81.5	75.8	64.9	43.0	11.7	1.24	.147	7.25E-3
Cu	L α	929.7	93.5	87.4	81.5	75.8	64.5	41.1	8.47	.880	.107	5.34E-3
Zn	L α	1011.7	93.6	87.5	81.6	75.8	64.3	39.0	5.91	.628	7.82E-2	3.94E-3
Mg	K α	1253.6	93.8	87.8	81.9	76.0	63.3	27.7	2.06	.251	3.31E-2	1.71E-3
Al	K α	1486.7	93.7	87.7	81.5	75.2	60.1	11.6	.869	.117	1.59E-2	8.36E-4
Si	K α	1740.0	93.5	87.1	80.5	73.2	53.0	4.03	.386	5.55E-2	7.75E-3	4.11E-4
Zr	L α	2042.4	92.3	84.7	76.3	65.9	26.3	1.22	.143	2.17E-2	3.10E-3	1.66E-4
Cl	K α	2622.4	82.9	67.4	52.3	36.7	9.46	.753	9.60E-2	1.49E-2	2.15E-3	1.16E-4
Ag	L α	2984.3	83.6	68.3	52.7	35.1	6.56	.519	6.75E-2	1.06E-2	1.53E-3	8.25E-5
Ca	K α	3691.7	84.9	69.8	51.8	26.3	2.68	.238	3.23E-2	5.15E-3	7.48E-4	4.04E-5
Ti	K α	4510.8	86.4	71.1	46.5	10.2	1.05	.105	1.48E-2	2.39E-3	3.49E-4	1.89E-5
V	K α	4952.2	86.9	71.1	38.5	5.74	.677	7.14E-2	1.02E-2	1.65E-3	2.41E-4	1.31E-5
Cr	K α	5414.7	87.3	70.6	24.4	3.41	.449	4.91E-2	7.06E-3	1.15E-3	1.68E-4	9.13E-6
Mn	K α	5898.8	87.7	69.5	12.8	2.13	.304	3.42E-2	4.97E-3	8.10E-4	1.19E-4	6.46E-6
Co	K α	6930.3	88.2	62.9	4.29	.929	.148	1.74E-2	2.55E-3	4.18E-4	6.15E-5	3.34E-6
Ni	K α	7478.2	88.4	53.0	2.74	.641	.106	1.26E-2	1.86E-3	3.05E-4	4.49E-5	2.44E-6
Cu	K α	8047.8	88.5	30.7	1.82	.451	7.67E-2	9.24E-3	1.37E-3	2.25E-4	3.32E-5	1.80E-6
Ge	K α	9886.4	88.3	5.38	.628	.172	3.10E-2	3.84E-3	5.74E-4	9.45E-5	1.39E-5	7.58E-7
Y	K α	14988.0	44.7	.627	.104	3.11E-2	5.90E-3	7.49E-4	1.13E-4	1.87E-5	2.76E-6	1.50E-7
Mo	K α	17479.0	15.9	.333	5.79E-2	1.76E-2	3.37E-3	4.29E-4	6.48E-5	1.07E-5	1.58E-6	8.61E-8
Pd	K α	21177.0	4.28	.147	2.67E-2	8.21E-3	1.59E-3	2.03E-4	3.07E-5	5.09E-6	7.52E-7	4.09E-8
Sn	K α	25271.0	1.62	6.96E-2	1.30E-2	4.02E-3	7.83E-4	1.01E-4	1.52E-5	2.52E-6	3.72E-7	2.03E-8
Xe	K α	29779.0	.720	3.50E-2	6.63E-3	2.07E-3	4.04E-4	5.20E-5	7.87E-6	1.30E-6	1.93E-7	1.05E-8

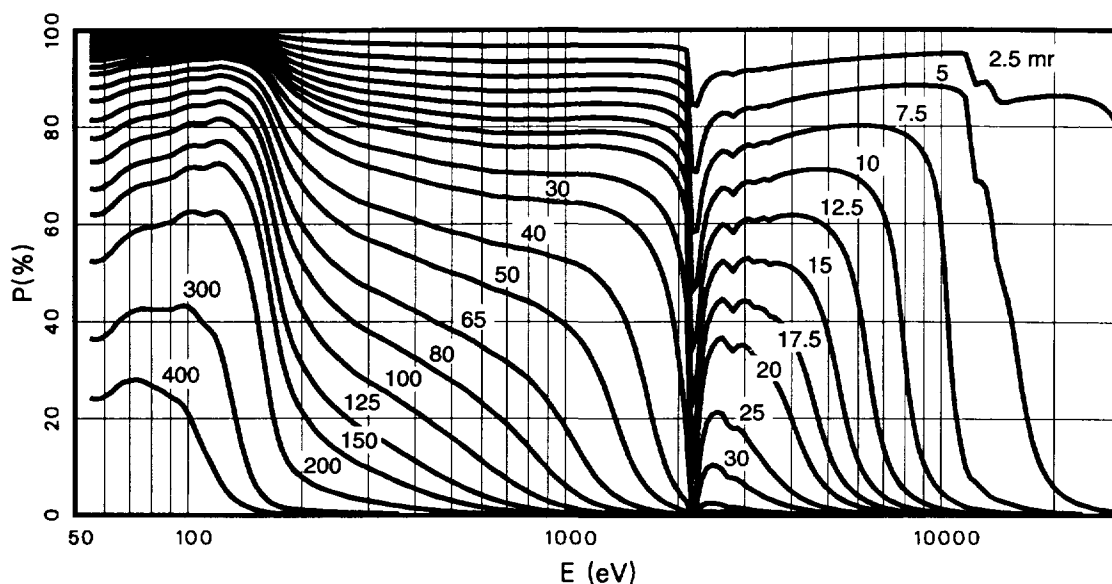

TABLE IV. Bragg Reflection Characteristics for Natural Crystals

See page 211 for Explanation of Tables

Silicon (422)

Si

2d = 2.217Å

Line	E(eV)	R _m (mr)	R _p (mr)	R _π /R _σ	P _π (%)	P _σ (%)	ω _π (mr)	ω _σ (mr)	E/ΔE _π	E/ΔE _σ	λ (Å)
Mn Kα	5899.	.181	.0456	.761	88.3	99.3	.0384	.0469	77600	63600	2.10
Tb Lα	6273.	.110	.0265	.531	81.7	99.1	.0189	.0313	104000	63000	1.98
Fe Kα	6404.	.0980	.0231	.461	79.4	99.2	.0154	.0284	117000	63200	1.94
Co Kα	6930.	.0735	.0150	.230	68.0	99.5	.0067	.0217	202000	63000	1.79
Ni Kα	7478.	.0646	.0108	.0601	41.9	99.1	.0023	.0180	486000	62400	1.66
Lu Lα	7656.	.0634	.0099	.0241	24.5	99.3	.0013	.0171	787000	62500	1.62
Cu Kα	8048.	.0625	.0088	.0076	10.9	99.2	.0008	.0155	1.2e+6	62300	1.54
W Lα	8398.	.0632	.0086	.0629	47.7	99.5	.0017	.0143	523000	62300	1.48
Zn Kα	8639.	.0641	.0086	.109	59.4	99.5	.0023	.0136	368000	62500	1.44
Re Lα	8912.	.0656	.0085	.161	70.3	99.5	.0028	.0129	287000	62200	1.39
Ga Kα	9252.	.0679	.0085	.221	77.4	99.7	.0033	.0121	227000	62500	1.34
Pt Lα	9442.	.0694	.0085	.252	80.2	99.6	.0035	.0118	205000	62400	1.31
Au Lα	9713.	.0717	.0084	.295	83.3	99.7	.0038	.0112	182000	62800	1.28
Ge Kα	9886.	.0730	.0084	.320	84.9	99.6	.0040	.0110	171000	62200	1.25
Hg Lα	9989.	.0738	.0083	.334	85.7	99.6	.0041	.0108	164000	62400	1.24
Y Kα	14990.	.127	.0065	.713	97.3	99.9	.0046	.0063	86900	63000	.827
Mo Kα	17480.	.155	.0057	.791	98.4	99.9	.0042	.0053	79400	63000	.709
Pd Kα	21180.	.197	.0048	.863	99.2	99.9	.0037	.0043	73600	63100	.585
Sn Kα	25270.	.245	.0041	.901	99.5	100.	.0032	.0035	70300	63500	.491
Xe Kα	29780.	.298	.0035	.932	99.7	100.	.0028	.0030	68200	63400	.416

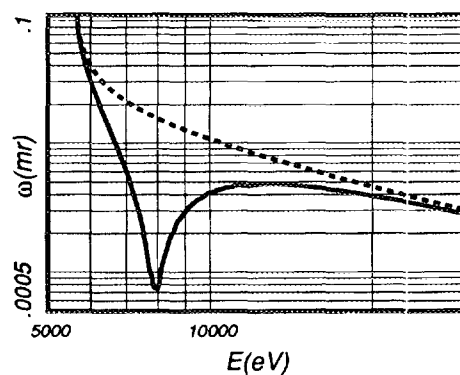
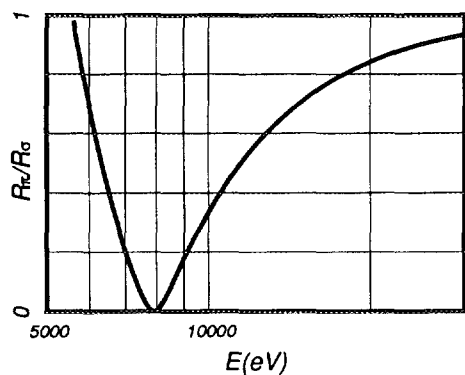
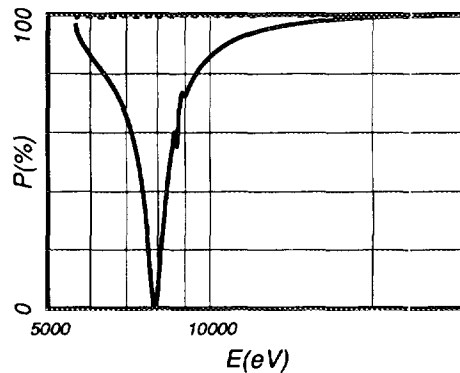
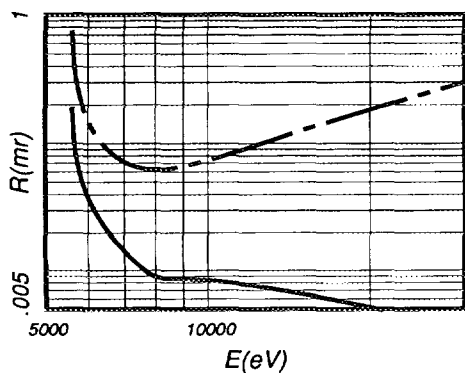

TABLE IV. Bragg Reflection Characteristics for Natural Crystals
See page 211 for Explanation of Tables

Germanium (422)

Ge
2d = 2.310Å

Line	E(eV)	R _m (mr)	R _p (mr)	R _π /R _σ	P _π (%)	P _σ (%)	ω _π (mr)	ω _σ (mr)	E/ΔE _π	E/ΔE _σ	λ (Å)
Cr Kα	5415.	1.20	.342	.955	94.8	99.5	.314	.318	27500	27000	2.29
Mn Kα	5899.	.258	.0722	.598	81.4	99.4	.0560	.0822	39300	26800	2.10
Tb Lα	6273.	.181	.0477	.388	73.5	99.3	.0301	.0622	55100	26600	1.98
Fe Kα	6404.	.167	.0425	.325	70.4	99.7	.0245	.0577	62700	26600	1.94
Co Kα	6930.	.134	.0289	.124	51.6	99.5	.0098	.0461	125000	26600	1.79
Ni Kα	7478.	.122	.0219	.0048	5.76	99.4	.0025	.0388	413000	26600	1.66
Lu Lα	7656.	.120	.0208	.0017	2.29	99.7	.0021	.0370	458000	26600	1.62
Cu Kα	8048.	.119	.0200	.0539	39.0	99.5	.0040	.0335	223000	26700	1.54
W Lα	8398.	.120	.0197	.121	58.5	99.7	.0058	.0310	142000	26900	1.48
Zn Kα	8639.	.122	.0196	.167	66.5	99.5	.0068	.0295	115000	26900	1.44
Re Lα	8912.	.124	.0194	.216	72.7	99.9	.0078	.0279	96400	27100	1.39
Ga Kα	9252.	.127	.0191	.272	78.0	99.8	.0087	.0262	81500	27200	1.34
Pt Lα	9442.	.128	.0189	.303	80.2	99.6	.0091	.0254	75700	27300	1.31
Au Lα	9713.	.130	.0186	.341	82.8	99.7	.0095	.0242	69400	27400	1.28
Ge Kα	9886.	.132	.0184	.365	84.2	99.6	.0097	.0234	66400	27600	1.25
Hg Lα	9989.	.133	.0182	.378	85.0	99.6	.0098	.0230	64900	27800	1.24
Y Kα	14990.	.0342	.0126	.683	79.1	98.7	.0109	.0138	35100	27800	.827
Mo Kα	17480.	.0411	.0120	.773	86.7	99.2	.0104	.0123	31200	26200	.709
Pd Kα	21180.	.0501	.0107	.849	92.4	99.6	.0092	.0104	28400	25100	.585
Sn Kα	25270.	.0593	.0094	.896	95.4	99.8	.0080	.0088	26900	24700	.491
Xe Kα	29780.	.0691	.0083	.929	97.2	99.7	.0070	.0074	26100	24500	.416

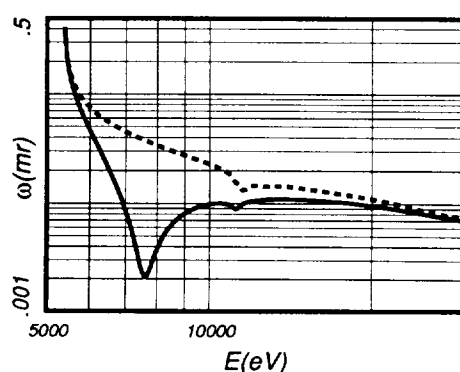
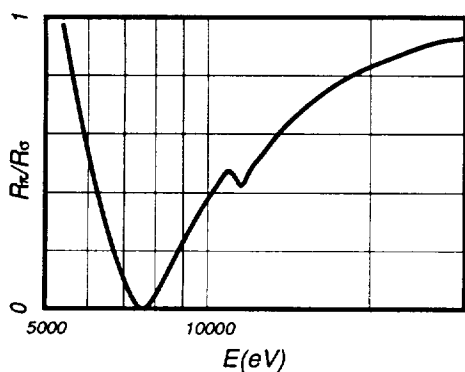
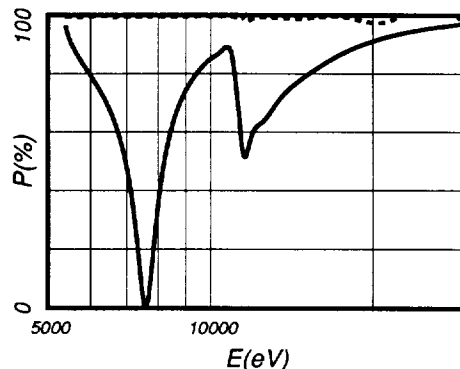
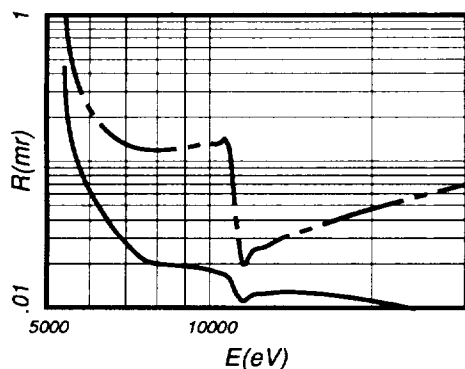

TABLE IV. Bragg Reflection Characteristics for Natural Crystals
See page 211 for Explanation of Tables

Lithium Fluoride (220)
LiF
2d = 2.848Å

Line	E(eV)	R _m (mr)	R _p (mr)	R _π /R _σ	P _π (%)	P _σ (%)	ω _π (mr)	ω _σ (mr)	E/ΔE _π	E/ΔE _σ	λ (Å)	
Ba	Lα	4466.	1.32	.134	.892	97.0	99.7	.110	.122	40100	36200	2.78
Ti	Kα	4511.	1.09	.111	.852	96.5	99.8	.0888	.102	41800	36200	2.75
V	Kα	4952.	.482	.0454	.519	92.5	99.8	.0280	.0509	65800	36200	2.50
Cr	Kα	5415.	.351	.0278	.262	87.0	99.8	.0111	.0372	122000	36300	2.29
Mn	Kα	5899.	.312	.0190	.0626	67.1	99.9	.0027	.0301	399000	36300	2.10
Tb	Lα	6273.	.308	.0161	.0182	42.0	99.9	.0010	.0265	947000	36400	1.98
Fe	Kα	6404.	.310	.0160	.0529	66.7	99.9	.0019	.0254	486000	36500	1.94
Co	Kα	6930.	.328	.0158	.189	88.6	99.9	.0047	.0221	171000	36500	1.79
Ni	Kα	7478.	.359	.0154	.304	93.6	99.9	.0063	.0196	113000	36500	1.66
Cu	Kα	8048.	.397	.0149	.403	95.8	99.9	.0073	.0178	88000	36600	1.54
W	Lα	8398.	.423	.0145	.451	96.7	99.9	.0076	.0166	79100	36600	1.48
Zn	Kα	8639.	.442	.0143	.482	97.1	100.	.0078	.0159	74300	36700	1.44
Ga	Kα	9252.	.491	.0137	.549	97.9	99.9	.0081	.0145	65800	36700	1.34
Pt	Lα	9442.	.507	.0135	.568	98.1	99.9	.0081	.0141	63800	36700	1.31
Au	Lα	9713.	.529	.0132	.592	98.3	100.	.0081	.0136	61300	36800	1.28
Ge	Kα	9886.	.544	.0131	.606	98.4	100.	.0082	.0133	59800	36800	1.25
Hg	Lα	9989.	.552	.0130	.614	98.5	100.	.0081	.0132	59100	36800	1.24
Y	Kα	14990.	1.01	.0092	.829	99.7	100.	.0068	.0082	44400	36900	.827
Mo	Kα	17480.	1.25	.0080	.874	99.8	100.	.0061	.0069	42200	37000	.709
Pd	Kα	21180.	1.63	.0067	.915	99.9	100.	.0051	.0056	40500	37000	.585
Sn	Kα	25270.	2.06	.0056	.940	99.9	100.	.0044	.0047	39300	37100	.491
Xe	Kα	29780.	2.54	.0048	.956	100.	100.	.0038	.0039	38700	37100	.416

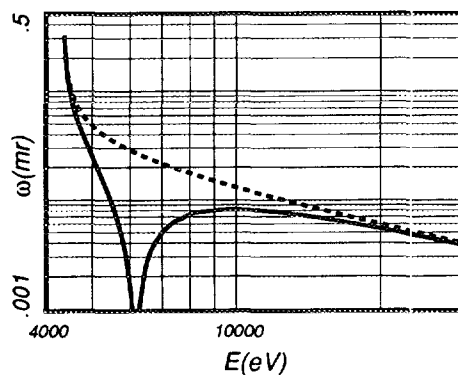
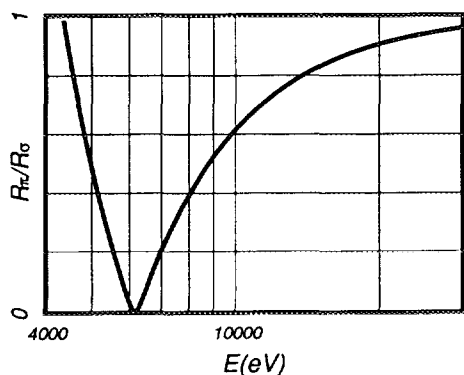
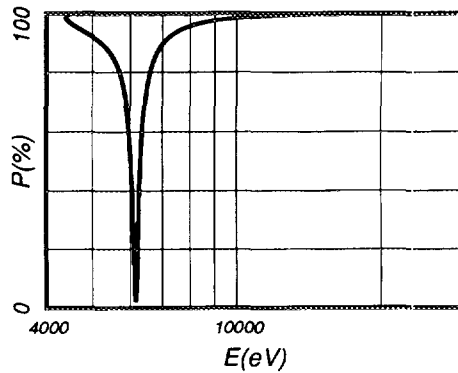
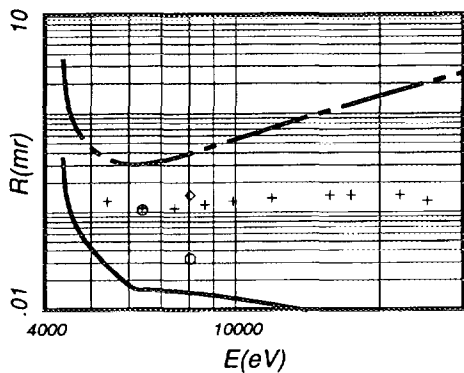

TABLE IV. Bragg Reflection Characteristics for Natural Crystals
See page 211 for Explanation of Tables

Silicon (220)
Si
2d = 3.840Å

Line	E(eV)	R _m (mr)	R _p (mr)	R _π /R _σ	P _π (%)	P _σ (%)	ω _π (mr)	ω _σ (mr)	E/ΔE _π	E/ΔE _σ	λ (Å)	
Ca	Kα	3692.	.185	.0774	.420	62.3	99.6	.0595	.0990	30400	18200	3.36
Ba	Lα	4466.	.117	.0341	.0068	4.27	99.5	.0073	.0618	143000	16900	2.78
Ti	Kα	4511.	.117	.0334	.0023	1.59	99.5	.0067	.0607	153000	16900	2.75
V	Kα	4952.	.118	.0306	.0691	32.9	99.6	.0091	.0519	94300	16600	2.50
Cr	Kα	5415.	.126	.0304	.205	61.0	99.5	.0138	.0455	53700	16300	2.29
Mn	Kα	5899.	.139	.0301	.331	74.6	99.5	.0167	.0403	39200	16200	2.10
Co	Kα	6930.	.170	.0283	.523	87.0	99.8	.0188	.0327	28000	16100	1.79
Ni	Kα	7478.	.187	.0272	.593	90.2	99.8	.0189	.0298	25300	16100	1.66
Cu	Kα	8048.	.206	.0260	.651	92.5	99.8	.0187	.0273	23500	16100	1.54
Zn	Kα	8639.	.225	.0248	.699	94.1	99.9	.0182	.0251	22100	16100	1.44
Pt	Lα	9442.	.250	.0232	.749	95.6	99.8	.0175	.0226	20800	16100	1.31
Au	Lα	9713.	.259	.0227	.764	96.0	99.9	.0172	.0219	20500	16100	1.28
Ge	Kα	9886.	.263	.0224	.772	96.2	99.9	.0170	.0215	20300	16100	1.25
Hg	Lα	9989.	.266	.0222	.778	96.3	99.9	.0169	.0212	20200	16100	1.24
Y	Kα	14990.	.419	.0157	.905	99.0	100.	.0124	.0136	17800	16200	.827
Mo	Kα	17480.	.496	.0136	.930	99.4	100.	.0108	.0116	17400	16200	.709
Pd	Kα	21180.	.614	.0113	.953	99.7	100.	.0090	.0094	17100	16300	.585
Sn	Kα	25270.	.749	.0095	.967	99.8	100.	.0076	.0079	16900	16300	.491
Xe	Kα	29780.	.901	.0081	.976	99.9	100.	.0065	.0066	16700	16300	.416

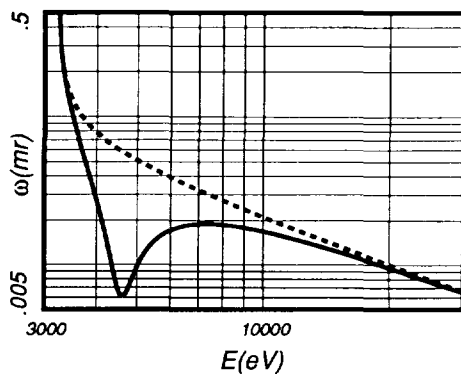
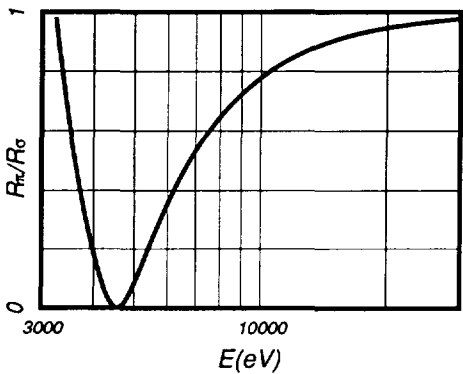
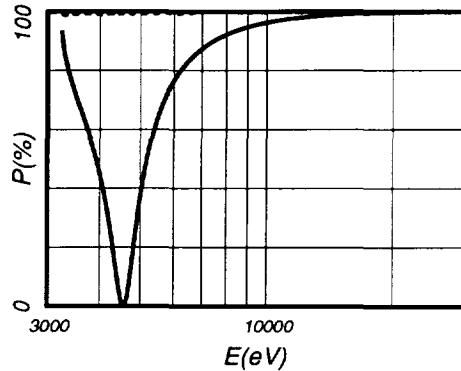
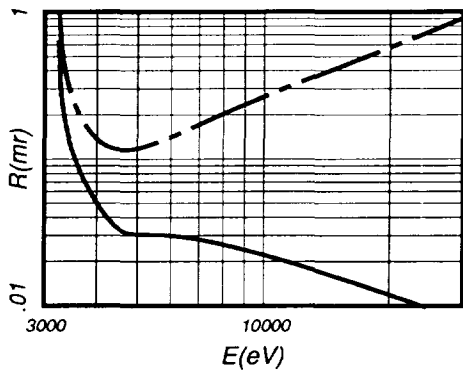

TABLE IV. Bragg Reflection Characteristics for Natural Crystals
See page 211 for Explanation of Tables

Fluorite (220)
CaF₂
2d = 3.862Å

Line	E(eV)	R _m (mr)	R _p (mr)	R _π /R _σ	P _π (%)	P _σ (%)	ω _π (mr)	ω _σ (mr)	E/ΔE _π	E/ΔE _σ	λ (Å)
Ca Kα	3692.	.679	.112	.465	85.4	99.9	.0703	.135	25100	13100	3.36
Ba Lα	4466.	.0941	.0386	.0026	.948	98.8	.0143	.0698	72300	14800	2.78
Ti Kα	4511.	.0946	.0382	.0003	.157	98.2	.0129	.0695	78600	14600	2.75
V Kα	4952.	.100	.0365	.0609	21.7	99.1	.0142	.0630	60100	13500	2.50
Cr Kα	5415.	.110	.0371	.187	48.3	98.9	.0191	.0572	38500	12900	2.29
Mn Kα	5899.	.122	.0374	.312	64.4	99.6	.0226	.0519	28700	12500	2.10
Co Kα	6930.	.149	.0364	.509	80.7	99.6	.0256	.0434	20400	12000	1.79
Ni Kα	7478.	.164	.0353	.583	85.2	99.8	.0258	.0399	18400	11900	1.66
Cu Kα	8048.	.179	.0341	.643	88.5	99.7	.0255	.0368	17000	11800	1.54
Zn Kα	8639.	.195	.0327	.692	90.9	99.8	.0250	.0340	16000	11800	1.44
Pt Lα	9442.	.215	.0309	.745	93.1	99.9	.0240	.0309	15100	11700	1.31
Au Lα	9713.	.222	.0303	.760	93.7	99.6	.0236	.0300	14800	11700	1.28
Ge Kα	9886.	.228	.0299	.768	94.1	99.8	.0234	.0294	14700	11700	1.25
Hg Lα	9989.	.232	.0297	.774	94.3	99.9	.0233	.0290	14600	11700	1.24
Y Kα	14990.	.356	.0213	.905	98.4	99.9	.0171	.0188	12800	11700	.827
Mo Kα	17480.	.416	.0185	.930	99.0	99.9	.0149	.0160	12500	11700	.709
Pd Kα	21180.	.505	.0155	.953	99.4	99.9	.0125	.0131	12300	11700	.585
Sn Kα	25270.	.605	.0131	.967	99.7	100.	.0106	.0109	12100	11700	.491
Xe Kα	29780.	.719	.0111	.977	99.8	100.	.0090	.0092	12000	11800	.416

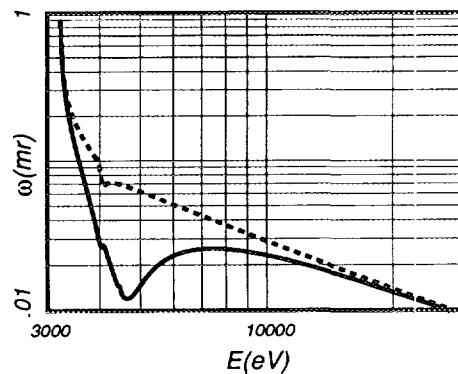
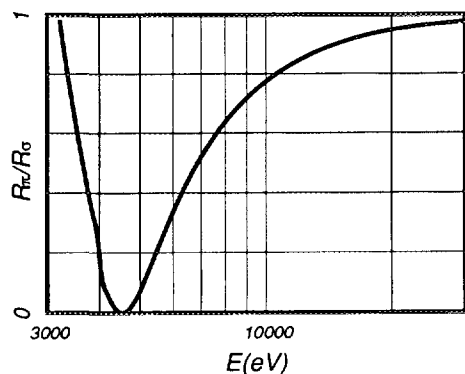
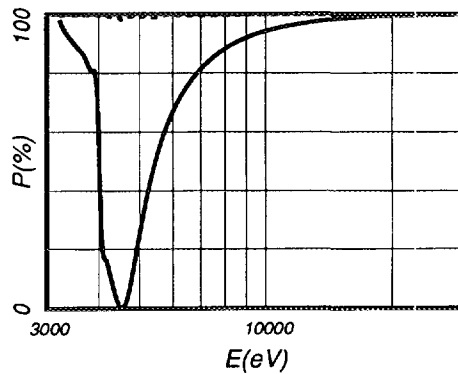
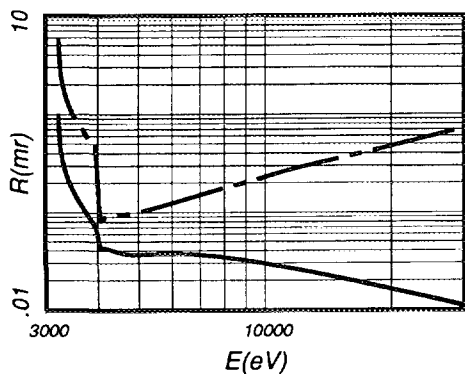

TABLE IV. Bragg Reflection Characteristics for Natural Crystals
See page 211 for Explanation of Tables

Germanium (220)
Ge
2d = 4.000Å

Line	E(eV)	R _m (mr)	R _p (mr)	R _π /R _σ	P _π (%)	P _σ (%)	ω _π (mr)	ω _σ (mr)	E/ΔE _π	E/ΔE _σ	λ (Å)
Ca Kα	3692.	.372	.152	.287	52.7	99.3	.102	.216	15100	7160	3.36
Ba Lα	4466.	.267	.0782	.0045	2.91	99.4	.0166	.142	58200	6780	2.78
Ti Kα	4511.	.267	.0773	.0101	6.23	99.6	.0171	.140	55400	6770	2.75
V Kα	4952.	.274	.0746	.125	45.1	99.8	.0288	.120	27900	6680	2.50
Cr Kα	5415.	.293	.0738	.261	65.5	99.6	.0382	.106	18300	6610	2.29
Mn Kα	5899.	.319	.0723	.379	76.3	99.7	.0434	.0939	14200	6580	2.10
Co Kα	6930.	.378	.0671	.557	87.1	99.9	.0465	.0761	10800	6570	1.79
Ni Kα	7478.	.408	.0641	.622	90.0	99.9	.0461	.0692	9890	6580	1.66
Cu Kα	8048.	.439	.0608	.675	92.2	99.8	.0449	.0632	9290	6600	1.54
Zn Kα	8639.	.468	.0575	.720	93.6	99.9	.0433	.0578	8870	6650	1.44
Pt Lα	9442.	.503	.0532	.767	95.2	99.9	.0408	.0517	8510	6720	1.31
Au Lα	9713.	.512	.0517	.780	95.6	99.9	.0399	.0498	8440	6760	1.28
Ge Kα	9886.	.520	.0508	.790	95.8	99.9	.0393	.0486	8410	6800	1.25
Hg Lα	9989.	.524	.0503	.795	96.0	99.9	.0389	.0479	8390	6820	1.24
Y Kα	14990.	.116	.0326	.894	91.6	99.6	.0294	.0314	7190	6740	.827
Mo Kα	17480.	.134	.0298	.923	94.5	99.7	.0265	.0279	6810	6460	.709
Pd Kα	21180.	.159	.0259	.951	96.8	99.7	.0226	.0235	6540	6300	.585
Sn Kα	25270.	.185	.0224	.967	98.1	99.9	.0193	.0198	6410	6230	.491
Xe Kα	29780.	.213	.0195	.977	98.8	100.	.0165	.0169	6330	6210	.416

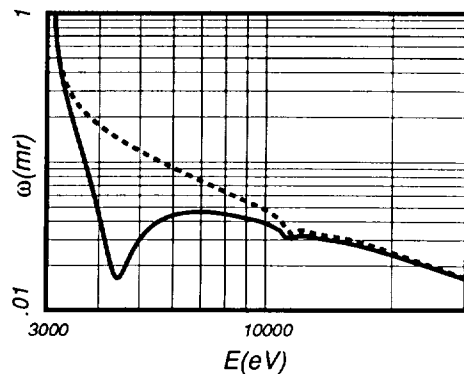
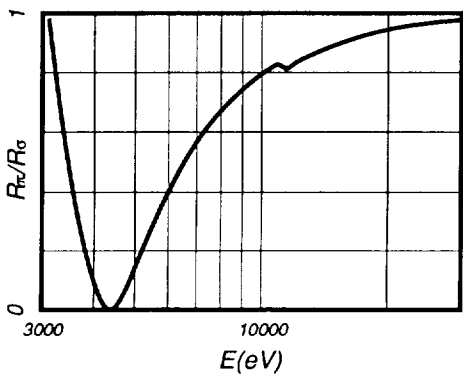
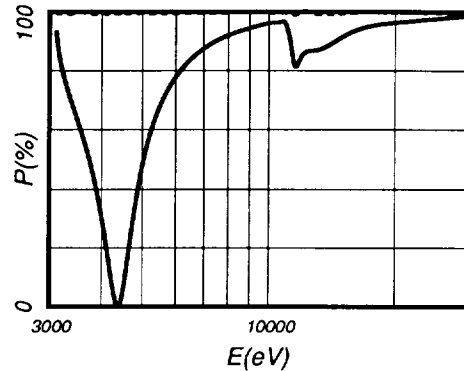
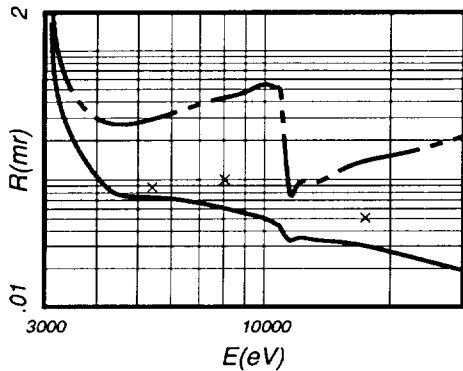

TABLE IV. Bragg Reflection Characteristics for Natural Crystals
See page 211 for Explanation of Tables

Lithium Fluoride (200)
LiF
2d = 4.027Å

Line	E(eV)	R _m (mr)	R _p (mr)	R _π /R _σ	P _π (%)	P _σ (%)	ω _π (mr)	ω _σ (mr)	E/ΔE _π	E/ΔE _σ	λ (Å)	
Ca	Kα	3692.	.707	.087	.350	85.3	99.9	.044	.111	34300	13600	3.36
Ba	Lα	4466.	.553	.042	.023	39.4	99.9	.003	.069	261000	13600	2.78
Ti	Kα	4511.	.555	.042	.038	51.3	99.9	.004	.068	192000	13600	2.75
V	Kα	4952.	.591	.041	.197	84.8	99.9	.013	.058	59200	13600	2.50
Cr	Kα	5415.	.655	.040	.330	91.8	99.9	.018	.050	38400	13700	2.29
Mn	Kα	5899.	.736	.038	.438	94.8	99.9	.020	.044	29900	13700	2.10
Co	Kα	6930.	.932	.034	.596	97.5	100.	.022	.036	22600	13700	1.79
Ni	Kα	7478.	1.04	.033	.654	98.1	100.	.021	.032	20700	13700	1.66
Cu	Kα	8048.	1.16	.031	.702	98.6	100.	.021	.030	19400	13800	1.54
Zn	Kα	8639.	1.28	.029	.742	98.9	100.	.020	.027	18500	13800	1.44
Pt	Lα	9442.	1.45	.027	.785	99.2	100.	.019	.025	17500	13800	1.31
Au	Lα	9713.	1.51	.026	.797	99.3	100.	.019	.024	17200	13800	1.28
Ge	Kα	9886.	1.55	.026	.803	99.3	100.	.019	.023	17100	13800	1.25
Hg	Lα	9989.	1.57	.026	.808	99.3	100.	.019	.023	17000	13800	1.24
Y	Kα	14990	2.69	.017	.915	99.8	100.	.013	.015	15100	13900	.827
Mo	Kα	17480	3.30	.015	.938	99.9	100.	.012	.012	14800	13900	.709
Pd	Kα	21180	4.23	.012	.958	99.9	100.	.010	.010	14500	13900	.585
Sn	Kα	25270	5.30	.010	.970	100.	100.	.008	.008	14300	13900	.491
Xe	Kα	29780	6.51	.009	.979	100.	100.	.007	.007	14200	13900	.416

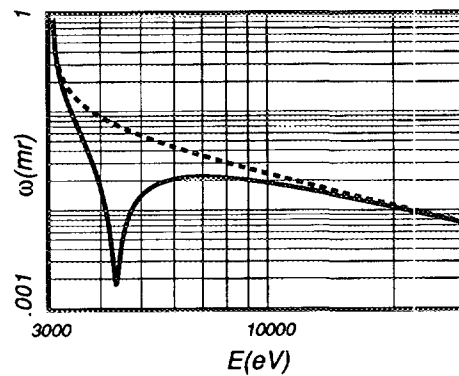
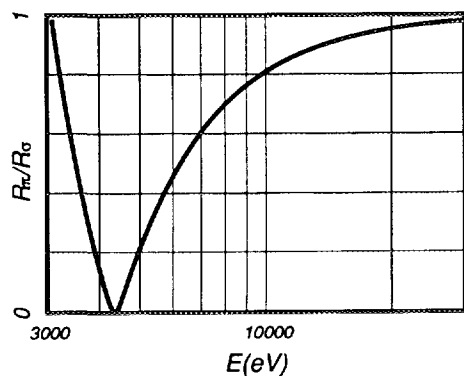
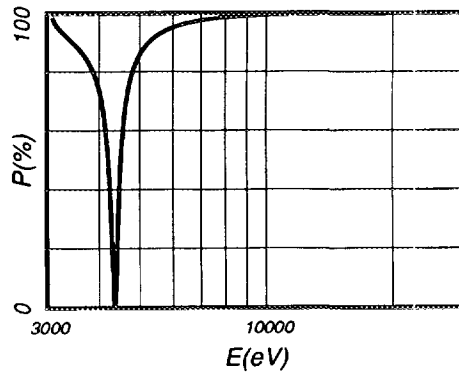
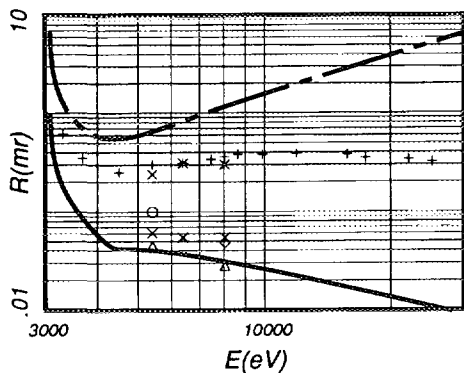

TABLE IV. Bragg Reflection Characteristics for Natural Crystals
See page 211 for Explanation of Tables

Copper (111)
Cu
2d = 4.174 Å

Line	E(eV)	R _m (mr)	R _p (mr)	R _π /R _σ	P _π (%)	P _σ (%)	ω _π (mr)	ω _σ (mr)	E/ΔE _π	E/ΔE _σ	λ (Å)	
Ag	Lα	2984.	10.23	3.93	.976	94.7	99.7	3.61	3.57	3730	3760	4.15
K	Kα	3314.	1.25	.466	.521	71.7	99.7	.369	.559	5490	3620	3.74
Ca	Kα	3692.	.784	.251	.190	50.5	99.8	.126	.384	10800	3530	3.36
Sc	Kα	4091.	.661	.169	.0108	7.80	99.9	.0325	.304	32600	3470	3.03
Ba	Lα	4466.	.645	.150	.0468	27.9	99.8	.0360	.259	24800	3440	2.78
Ti	Kα	4511.	.646	.150	.0602	33.1	99.7	.0390	.254	22400	3440	2.75
V	Kα	4952.	.679	.147	.203	63.6	99.8	.0640	.219	11700	3420	2.50
Cr	Kα	5415.	.734	.144	.334	76.7	99.7	.0784	.192	8370	3420	2.29
Mn	Kα	5899.	.799	.139	.442	83.8	99.8	.0856	.170	6810	3430	2.10
Tb	Lα	6273.	.851	.135	.509	87.2	99.9	.0878	.157	6130	3440	1.98
Fe	Kα	6404.	.869	.133	.530	88.2	99.9	.0881	.152	5950	3440	1.94
Co	Kα	6930.	.939	.126	.601	91.1	99.9	.0877	.137	5410	3460	1.79
Ni	Kα	7478.	1.00	.119	.659	93.0	99.9	.0855	.124	5070	3500	1.66
Lu	Lα	7656.	1.02	.116	.675	93.5	99.9	.0844	.120	4990	3520	1.62
Cu	Kα	8048.	1.05	.111	.707	94.5	99.9	.0817	.111	4860	3570	1.54
W	Lα	8398.	1.06	.105	.732	95.1	99.9	.0784	.104	4830	3650	1.48
Zn	Kα	8639.	1.03	.0998	.746	95.4	99.9	.0751	.0977	4880	3750	1.44
Ga	Kα	9252.	.149	.0708	.729	75.0	99.4	.0659	.0727	5150	4670	1.34
Pt	Lα	9442.	.161	.0732	.743	76.8	99.5	.0677	.0752	4900	4410	1.31
Au	Lα	9713.	.173	.0750	.760	78.9	99.7	.0688	.0767	4670	4190	1.28
Ge	Kα	9886.	.180	.0755	.769	80.1	99.5	.0691	.0773	4560	4080	1.25
Hg	Lα	9989.	.184	.0758	.775	80.7	99.4	.0692	.0775	4500	4020	1.24

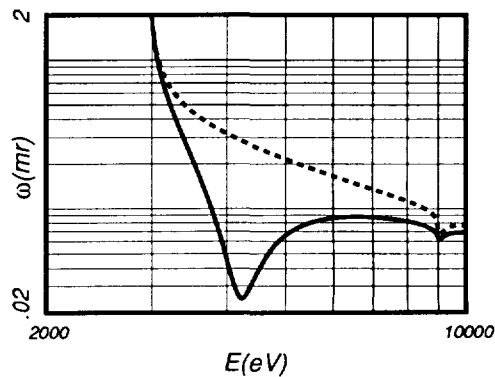
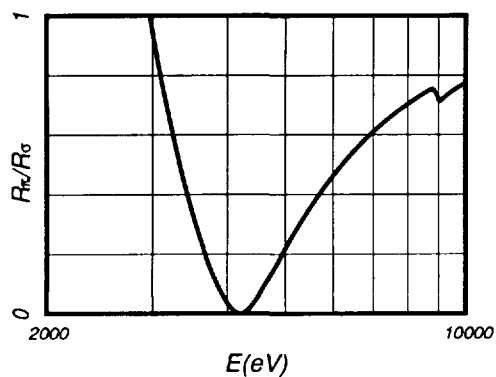
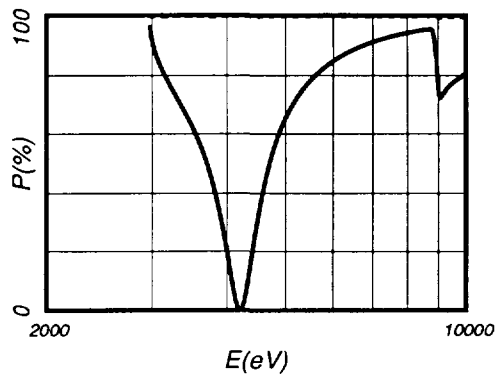
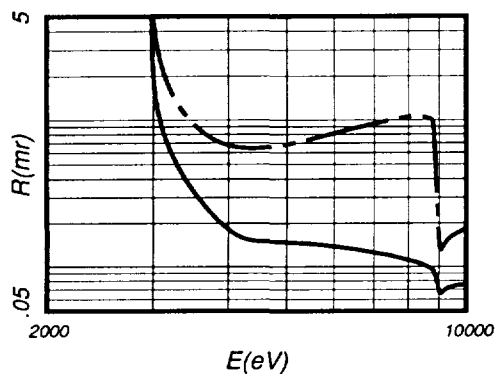

TABLE IV. Bragg Reflection Characteristics for Natural Crystals
See page 211 for Explanation of Tables

Aluminum (111)
Al
2d = 4.678Å

Line	E(eV)	R _m (mr)	R _p (mr)	R _π /R _σ	P _π (%)	P _σ (%)	ω _π (mr)	ω _σ (mr)	E/ΔE _π	E/ΔE _σ	λ (Å)	
Ag	Lα	2984.	.351	.154	.470	63.7	99.6	.126	.190	15400	10200	4.15
K	Kα	3314.	.235	.0878	.161	41.1	99.7	.0459	.138	29000	9660	3.74
Ca	Kα	3692.	.204	.0610	.0031	1.95	99.6	.0131	.111	78500	9290	3.36
Sc	Kα	4091.	.207	.0556	.0759	33.9	99.5	.0176	.0939	48400	9060	3.03
Ba	Lα	4466.	.222	.0553	.210	60.5	99.5	.0258	.0825	26600	8940	2.78
Ti	Kα	4511.	.224	.0553	.225	62.5	99.8	.0265	.0813	27400	8930	2.75
V	Kα	4952.	.249	.0545	.359	76.0	99.7	.0316	.0717	20100	8840	2.50
Cr	Kα	5415.	.278	.0529	.468	83.4	99.9	.0340	.0638	16500	8800	2.29
Mn	Kα	5899.	.310	.0509	.556	88.1	99.9	.0348	.0574	14500	8770	2.10
Tb	Lα	6273.	.335	.0491	.610	90.5	99.9	.0347	.0533	13400	8750	1.98
Fe	Kα	6404.	.344	.0485	.626	91.1	99.8	.0346	.0520	13200	8750	1.94
Co	Kα	6930.	.380	.0461	.683	93.3	99.9	.0338	.0473	12200	8750	1.79
Ni	Kα	7478.	.416	.0437	.730	94.8	99.8	.0327	.0433	11600	8750	1.66
Lu	Lα	7656.	.428	.0429	.742	95.2	99.9	.0323	.0422	11400	8750	1.62
Cu	Kα	8048.	.454	.0413	.769	95.8	99.9	.0314	.0398	11100	8760	1.54
W	Lα	8398.	.477	.0400	.789	96.4	100.	.0306	.0380	10900	8760	1.48
Zn	Kα	8639.	.493	.0391	.801	96.7	99.9	.0300	.0368	10700	8760	1.44
Ga	Kα	9252.	.533	.0369	.827	97.4	99.9	.0286	.0341	10500	8770	1.34
Pt	Lα	9442.	.546	.0363	.835	97.5	99.9	.0282	.0333	10400	8780	1.31
Au	Lα	9713.	.563	.0354	.844	97.8	99.9	.0276	.0323	10300	8770	1.28
Ge	Kα	9886.	.573	.0349	.850	97.9	99.9	.0272	.0317	10200	8790	1.25
Hg	Lα	9989.	.577	.0346	.853	97.9	99.9	.0270	.0313	10200	8780	1.24

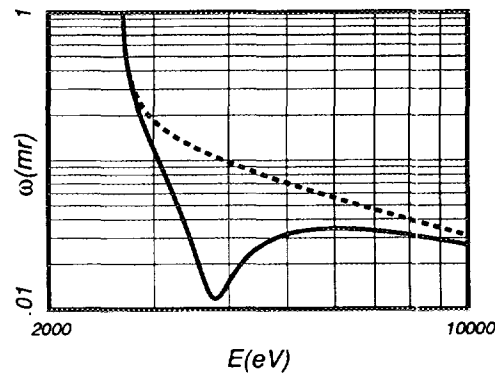
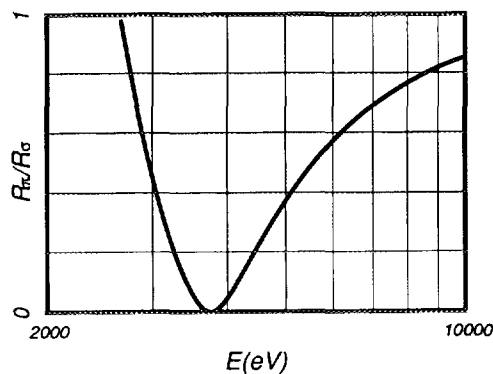
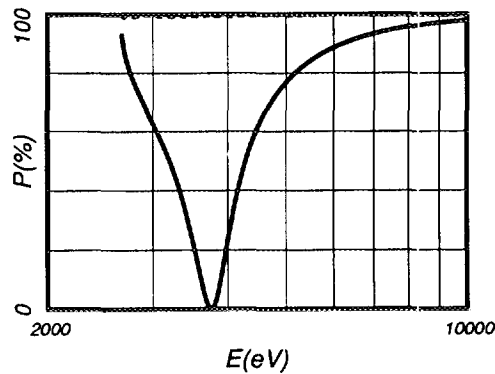
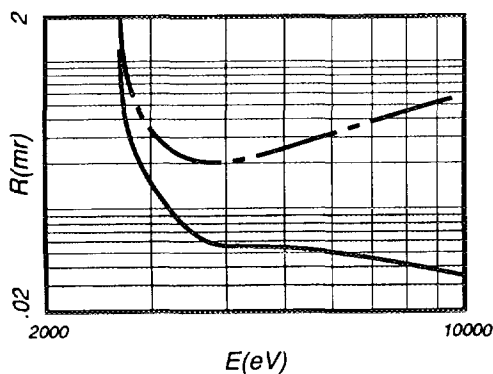

TABLE IV. Bragg Reflection Characteristics for Natural Crystals
See page 211 for Explanation of Tables

Silicon (111)
Si
 $2d = 6.271 \text{ \AA}$

Line	E(eV)	R_m (mr)	R_p (mr)	R_π/R_σ	P_π (%)	P_σ (%)	ω_π (mr)	ω_σ (mr)	$E/\Delta E_\pi$	$E/\Delta E_\sigma$	λ (Å)
Zr $L\alpha$	2042.	.300	.239	.790	39.7	47.9	.391	.414	9940	9390	6.07
Nb $L\alpha$	2166.	.170	.131	.494	31.2	52.4	.204	.254	11000	8830	5.72
Mo $L\alpha$	2293.	.128	.0940	.286	23.1	56.1	.131	.201	13000	8460	5.41
Cl $K\alpha$	2622.	.0950	.0595	.0280	4.19	63.6	.0534	.145	21500	7910	4.73
Ag $L\alpha$	2984.	.0933	.0511	.0252	5.13	69.7	.0339	.117	26100	7570	4.15
Ca $K\alpha$	3692.	.114	.0526	.291	46.3	78.0	.0402	.0877	15800	7230	3.36
Ba $L\alpha$	4466.	.144	.0525	.525	69.0	83.7	.0432	.0698	11400	7070	2.78
Ti $K\alpha$	4511.	.146	.0524	.535	69.8	84.0	.0432	.0690	11300	7070	2.75
V $K\alpha$	4952.	.164	.0510	.621	76.5	86.3	.0426	.0620	10200	7030	2.50
Cr $K\alpha$	5415.	.182	.0491	.689	81.3	88.1	.0413	.0561	9490	7000	2.29
Mn $K\alpha$	5899.	.200	.0469	.742	84.9	89.8	.0396	.0509	8980	6990	2.10
Co $K\alpha$	6930.	.238	.0423	.819	89.7	92.3	.0357	.0426	8330	6990	1.79
Ni $K\alpha$	7478.	.258	.0401	.846	91.4	93.3	.0338	.0392	8110	7000	1.66
Cu $K\alpha$	8048.	.279	.0379	.868	92.7	94.2	.0319	.0362	7960	7010	1.54
Zn $K\alpha$	8639.	.300	.0358	.887	93.8	94.9	.0301	.0335	7820	7010	1.44
Pt $L\alpha$	9442.	.328	.0333	.906	94.9	95.7	.0278	.0305	7700	7030	1.31
Au $L\alpha$	9713.	.338	.0325	.909	95.2	95.9	.0271	.0295	7660	7040	1.28
Ge $K\alpha$	9886.	.343	.0320	.913	95.4	96.0	.0267	.0290	7640	7040	1.25
Hg $L\alpha$	9989.	.346	.0317	.915	95.4	96.1	.0265	.0287	7630	7040	1.24

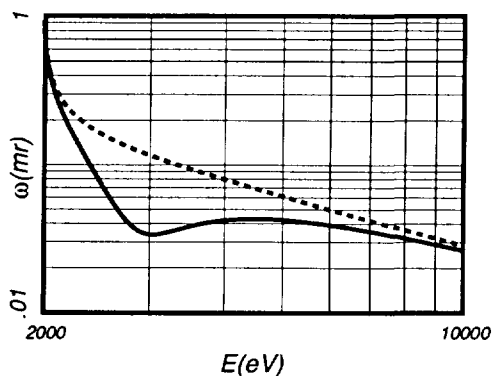
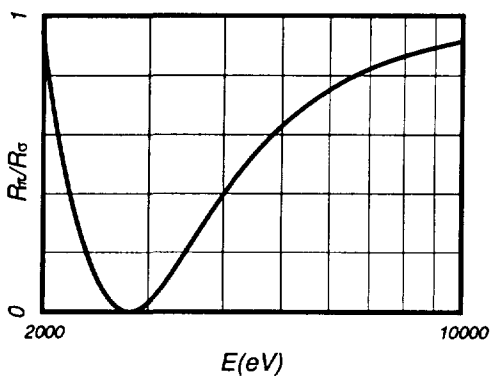
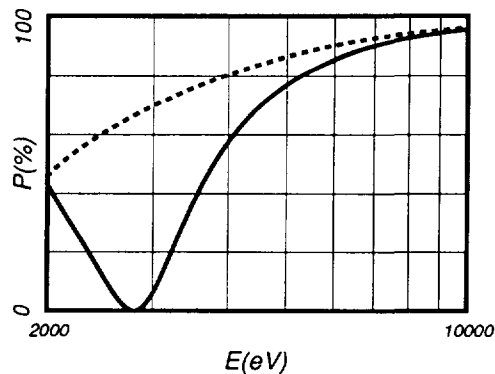
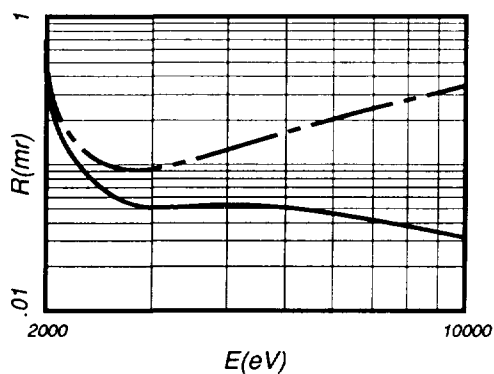

TABLE IV. Bragg Reflection Characteristics for Natural Crystals
See page 211 for Explanation of Tables

Fluorite (111)
CaF₂
2d = 6.306Å

Line	E(eV)	R _m (mr)	R _p (mr)	R _π /R _σ	P _π (%)	P _σ (%)	ω _π (mr)	ω _σ (mr)	E/ΔE _π	E/ΔE _σ	λ (Å)
Zr Lα	2042.	.499	.262	.797	59.7	65.1	.316	.366	11300	9710	6.07
Nb Lα	2166.	.273	.140	.536	53.3	67.7	.147	.222	14700	9750	5.72
Mo Lα	2293.	.197	.0961	.333	45.1	70.1	.0837	.170	19900	9800	5.41
Cl Kα	2622.	.137	.0534	.0355	12.1	75.2	.0215	.114	52600	9930	4.73
Ag Lα	2984.	.128	.0430	.0456	18.2	79.4	.0150	.0866	58300	10100	4.15
Ca Kα	3692.	.135	.0392	.346	65.5	84.4	.0252	.0578	25000	10900	3.36
Ba Lα	4466.	.0451	.0279	.463	47.3	76.8	.0288	.0403	17000	12200	2.78
Ti Kα	4511.	.0463	.0282	.475	48.7	77.3	.0290	.0404	16700	12000	2.75
V Kα	4952.	.0560	.0302	.575	59.9	81.2	.0294	.0395	14700	10900	2.50
Cr Kα	5415.	.0644	.0307	.654	68.1	84.1	.0292	.0376	13400	10400	2.29
Mn Kα	5899.	.0721	.0305	.716	74.4	86.4	.0285	.0354	12400	9970	2.10
Co Kα	6930.	.0868	.0290	.804	82.9	89.9	.0265	.0311	11200	9520	1.79
Ni Kα	7478.	.0939	.0279	.834	85.8	91.2	.0253	.0291	10800	9380	1.66
Cu Kα	8048.	.101	.0268	.860	88.1	92.3	.0241	.0271	10500	9280	1.54
Zn Kα	8639.	.108	.0256	.880	90.0	93.3	.0229	.0254	10200	9210	1.44
Pt Lα	9442.	.118	.0241	.901	91.9	94.3	.0213	.0233	9980	9150	1.31
Au Lα	9713.	.121	.0236	.907	92.4	94.6	.0209	.0226	9910	9130	1.28
Ge Kα	9886.	.124	.0234	.911	92.8	94.8	.0206	.0223	9870	9110	1.25
Hg Lα	9989.	.126	.0232	.913	93.0	94.9	.0204	.0220	9840	9110	1.24

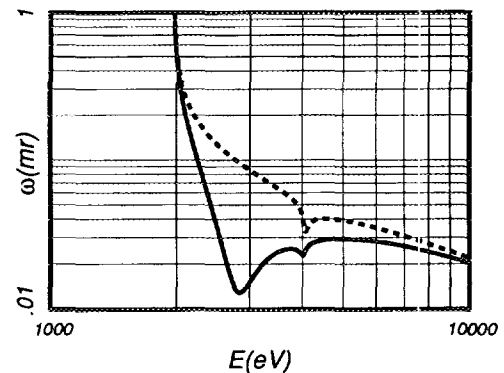
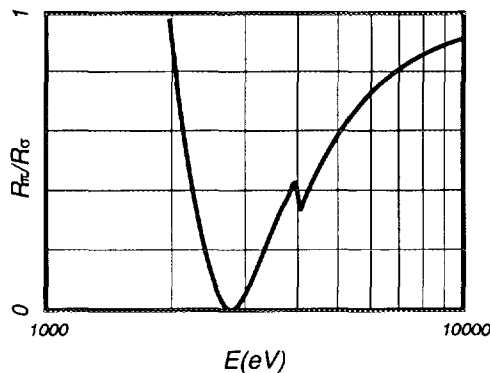
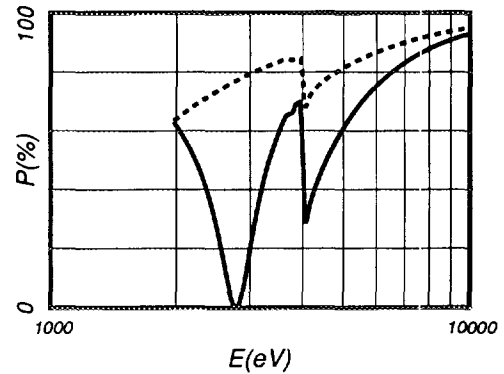
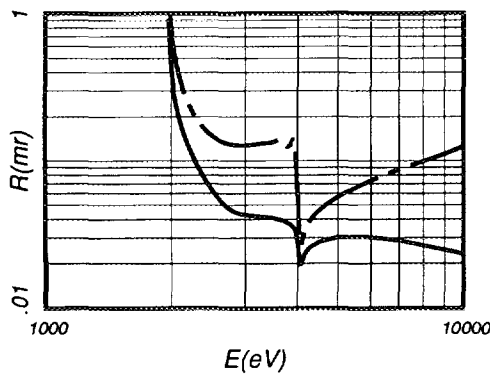

TABLE IV. Bragg Reflection Characteristics for Natural Crystals
See page 211 for Explanation of Tables

Germanium (111)
Ge
2d = 6.532Å

Line	E(eV)	R _m (mr)	R _p (mr)	R _π /R _σ	P _π (%)	P _σ (%)	ω _π (mr)	ω _σ (mr)	E/ΔE _π	E/ΔE _σ	λ (Å)
Zr Lα	2042.	.540	.415	.577	34.8	52.1	.645	.765	3920	3300	6.07
Nb Lα	2166.	.362	.269	.339	25.6	55.2	.389	.560	4690	3250	5.72
Mo Lα	2293.	.285	.201	.176	16.8	58.0	.256	.460	5770	3210	5.41
Cl Kα	2622.	.221	.135	.0036	.60	64.4	.112	.335	9360	3130	4.73
Ag Lα	2984.	.220	.122	.0600	11.2	69.8	.0871	.269	9470	3060	4.15
Ca Kα	3692.	.264	.124	.338	49.2	77.5	.101	.201	5960	2990	3.36
Ba Lα	4466.	.322	.121	.557	69.3	83.0	.103	.159	4550	2960	2.78
Ti Kα	4511.	.325	.121	.567	70.0	83.2	.103	.157	4500	2960	2.75
V Kα	4952.	.357	.117	.647	76.1	85.4	.100	.141	4140	2950	2.50
Cr Kα	5415.	.389	.112	.710	80.7	87.3	.0964	.127	3880	2950	2.29
Mn Kα	5899.	.421	.106	.760	84.1	88.9	.0917	.115	3710	2950	2.10
Co Kα	6930.	.484	.0949	.831	88.8	91.4	.0818	.0960	3480	2970	1.79
Ni Kα	7478.	.515	.0895	.856	90.4	92.4	.0769	.0881	3410	2980	1.66
Cu Kα	8048.	.545	.0843	.877	91.7	93.3	.0722	.0811	3360	2990	1.54
Zn Kα	8639.	.573	.0792	.894	92.8	94.0	.0676	.0748	3330	3010	1.44
Pt Lα	9442.	.608	.0729	.913	94.0	94.8	.0620	.0674	3310	3050	1.31
Au Lα	9713.	.618	.0708	.918	94.3	95.0	.0601	.0651	3310	3060	1.28
Ge Kα	9886.	.626	.0695	.921	94.5	95.2	.0590	.0636	3320	3080	1.25
Hg Lα	9989.	.631	.0687	.922	94.6	95.3	.0583	.0628	3320	3080	1.24

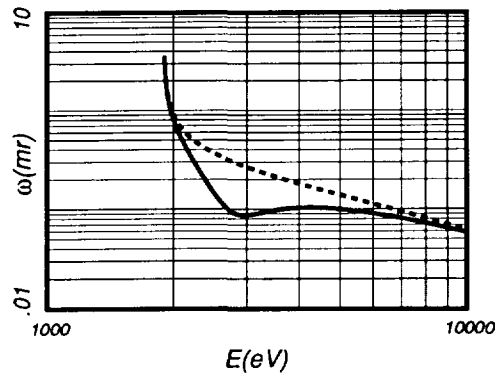
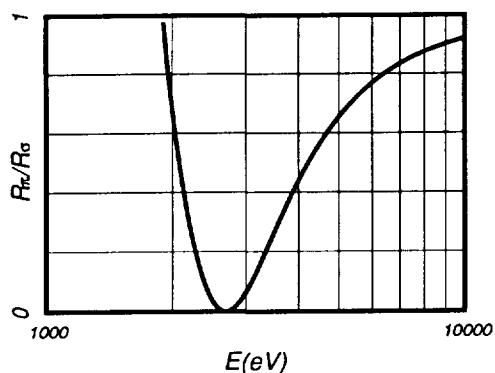
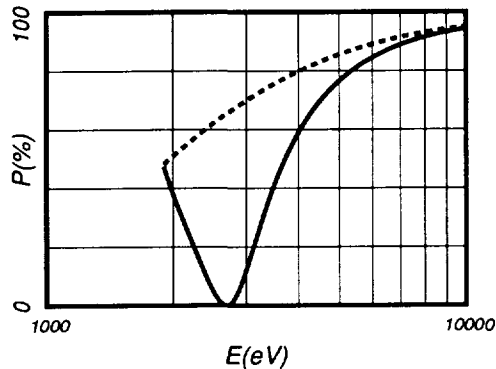
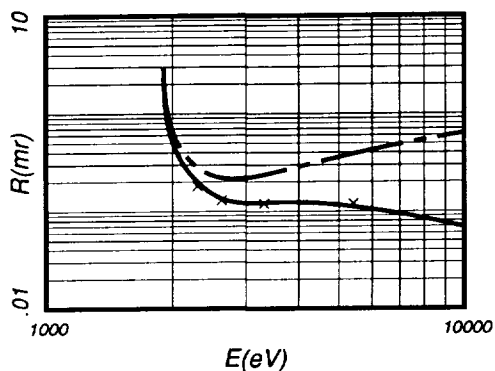

TABLE IV. Bragg Reflection Characteristics for Natural Crystals
See page 211 for Explanation of Tables

Graphite (0002)
C
2d = 6.708Å

Line	E(eV)	R _m (mr)	R _p (mr)	R _π /R _σ	P _π (%)	P _σ (%)	ω _π (mr)	ω _σ (mr)	E/ΔE _π	E/ΔE _σ	λ (Å)
Zr Lα	2042.	3.34	.434	.615	91.6	100.	.304	.466	7090	4620	6.07
Nb Lα	2166.	2.45	.295	.425	88.1	99.9	.167	.357	9860	4620	5.72
Mo Lα	2293.	2.04	.218	.264	83.1	99.9	.0914	.296	15000	4630	5.41
Cl Kα	2622.	1.75	.127	.0007	2.77	99.9	.0049	.215	204000	4640	4.73
Ag Lα	2984.	1.88	.122	.202	86.1	99.9	.0396	.170	20000	4650	4.15
Ca Kα	3692.	2.48	.111	.482	96.0	100.	.0620	.124	9360	4680	3.36
Ba Lα	4466.	3.29	.0973	.650	98.2	100.	.0639	.0971	7130	4690	2.78
Ti Kα	4511.	3.34	.0965	.657	98.3	100.	.0638	.0959	7060	4690	2.75
V Kα	4952.	3.83	.0897	.716	98.8	100.	.0619	.0858	6510	4700	2.50
Cr Kα	5415.	4.35	.0832	.763	99.1	100.	.0593	.0773	6130	4710	2.29
Mn Kα	5899.	4.91	.0773	.801	99.4	100.	.0564	.0702	5860	4710	2.10
Co Kα	6930.	6.14	.0669	.856	99.6	100.	.0504	.0588	5500	4720	1.79
Ni Kα	7478.	6.82	.0624	.877	99.7	100.	.0475	.0541	5380	4720	1.66
Cu Kα	8048.	7.53	.0583	.894	99.8	100.	.0448	.0500	5280	4730	1.54
Zn Kα	8639.	8.30	.0545	.908	99.8	100.	.0422	.0464	5210	4730	1.44
Pt Lα	9442.	9.36	.0501	.923	99.9	100.	.0390	.0423	5130	4730	1.31
Au Lα	9713.	9.73	.0487	.927	99.9	100.	.0381	.0410	5100	4730	1.28
Ge Kα	9886.	10.00	.0479	.930	99.9	100.	.0375	.0403	5090	4730	1.25
Hg Lα	9989.	10.16	.0474	.931	99.9	100.	.0371	.0399	5080	4730	1.24

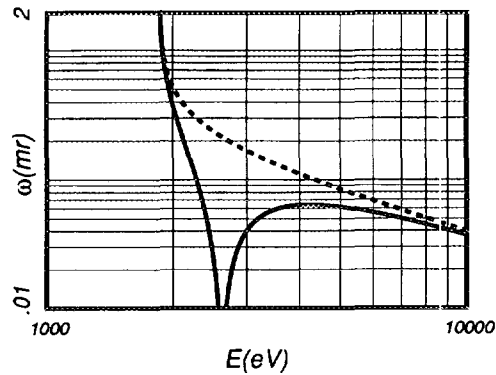
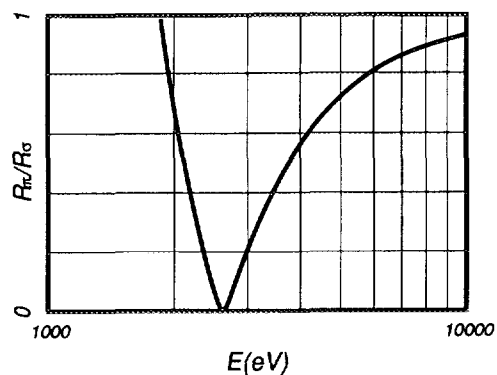
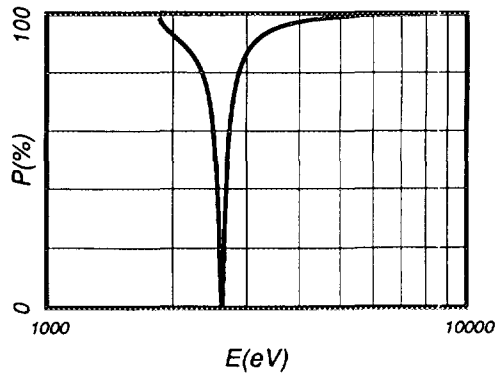
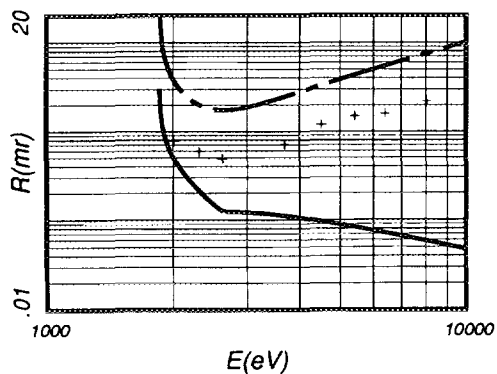

TABLE IV. Bragg Reflection Characteristics for Natural Crystals
See page 211 for Explanation of Tables

Indium Antimonide (111)
InSb
 $2d = 7.481\text{\AA}$

Line	E(eV)	$R_m(\text{mr})$	$R_p(\text{mr})$	R_π/R_σ	$P_\pi(\%)$	$P_\sigma(\%)$	$\omega_\pi(\text{mr})$	$\omega_\sigma(\text{mr})$	$E/\Delta E_\pi$	$E/\Delta E_\sigma$	$\lambda(\text{\AA})$
Si $K\alpha$	1740.	1.08	.767	.715	45.0	56.1	1.09	1.24	2900	2540	7.13
Zr $L\alpha$	2042.	.389	.248	.142	17.3	62.5	.257	.556	5410	2500	6.07
Nb $L\alpha$	2166.	.336	.201	.0457	7.24	64.8	.169	.478	7050	2490	5.72
Mo $L\alpha$	2293.	.309	.174	.0034	.667	66.9	.121	.422	8640	2480	5.41
Cl $K\alpha$	2622.	.296	.153	.0702	14.2	71.5	.101	.331	8080	2470	4.73
Ag $L\alpha$	2984.	.311	.150	.238	38.9	75.5	.115	.269	5830	2480	4.15
Ca $K\alpha$	3692.	.248	.128	.472	58.4	81.0	.112	.178	4500	2830	3.36
Ba $L\alpha$	4466.	.102	.0778	.573	34.1	51.1	.123	.147	3250	2720	2.78
Ti $K\alpha$	4511.	.107	.0805	.582	35.7	52.5	.123	.148	3200	2670	2.75
V $K\alpha$	4952.	.121	.0855	.658	42.3	55.7	.122	.144	2910	2460	2.50
Cr $K\alpha$	5415.	.139	.0908	.721	50.5	61.2	.118	.137	2740	2340	2.29
Mn $K\alpha$	5899.	.155	.0927	.771	57.2	65.6	.112	.129	2600	2270	2.10
Co $K\alpha$	6930.	.182	.0915	.843	67.4	72.6	.102	.113	2420	2170	1.79
Ni $K\alpha$	7478.	.195	.0895	.869	71.3	75.4	.0966	.106	2350	2140	1.66
Cu $K\alpha$	8048.	.208	.0870	.890	74.7	77.9	.0915	.0994	2300	2120	1.54
Zn $K\alpha$	8639.	.220	.0841	.906	77.6	80.1	.0866	.0931	2260	2100	1.44
Pt $L\alpha$	9442.	.236	.0801	.924	80.7	82.6	.0805	.0855	2220	2080	1.31
Au $L\alpha$	9713.	.241	.0788	.928	81.6	83.3	.0786	.0832	2210	2080	1.28
Ge $K\alpha$	9886.	.242	.0778	.931	82.0	83.7	.0773	.0817	2200	2080	1.25
Hg $L\alpha$	9989.	.242	.0771	.933	82.2	83.8	.0766	.0809	2200	2080	1.24

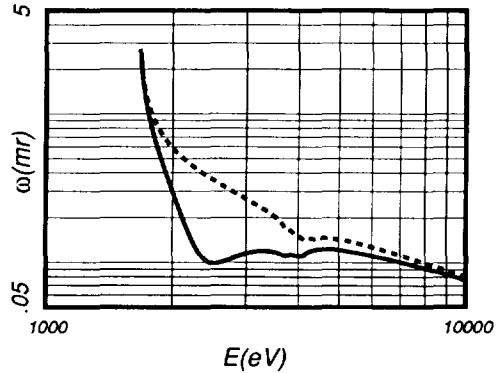
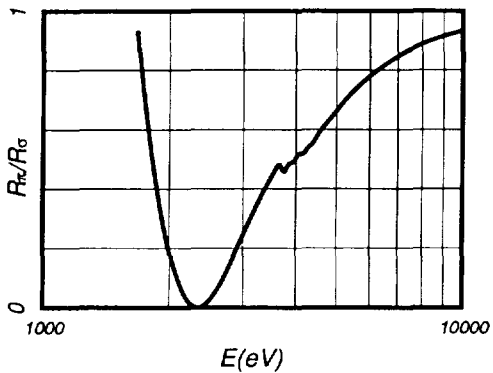
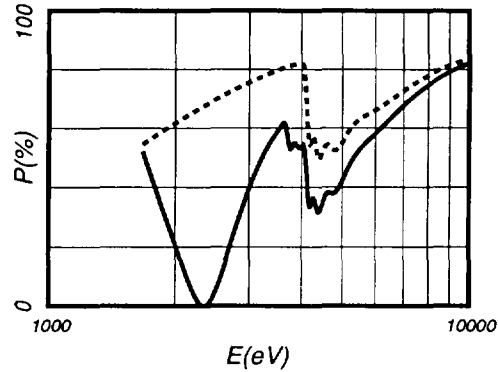
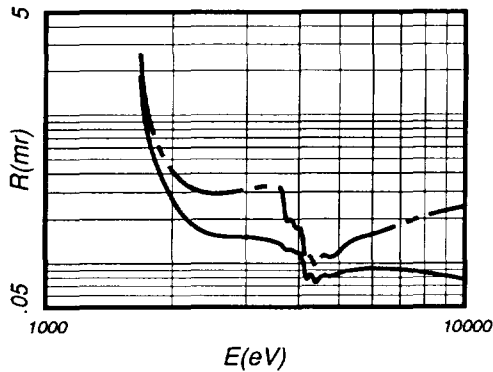

TABLE IV. Bragg Reflection Characteristics for Natural Crystals
See page 211 for Explanation of Tables

Ammonium Dihydrogen Phosphate -ADP (200)
 $\text{NH}_4\text{H}_2\text{PO}_4$
 $2d = 7.500\text{\AA}$

Line	E(eV)	$R_m(\text{mr})$	$R_p(\text{mr})$	R_π/R_σ	$P_\pi(\%)$	$P_\sigma(\%)$	$\omega_\pi(\text{mr})$	$\omega_\sigma(\text{mr})$	$E/\Delta E_\pi$	$E/\Delta E_\sigma$	$\lambda(\text{\AA})$
Si $K\alpha$	1740.	.531	.238	.747	65.1	71.2	.256	.316	11900	9670	7.13
Zr $L\alpha$	2042.	.183	.0721	.188	40.4	76.0	.0439	.133	31500	10400	6.07
Nb $L\alpha$	2166.	.0999	.0462	.0536	13.4	71.4	.0255	.101	46600	11600	5.72
Mo $L\alpha$	2293.	.0697	.0403	.0027	.515	68.6	.0286	.0949	36300	11000	5.41
Cl $K\alpha$	2622.	.0801	.0399	.0755	16.5	75.5	.0245	.0818	33200	9920	4.73
Ag $L\alpha$	2984.	.0940	.0418	.252	44.5	80.3	.0295	.0702	22600	9470	4.15
Ca $K\alpha$	3692.	.124	.0423	.520	71.3	86.3	.0335	.0550	14900	9100	3.36
Ba $L\alpha$	4466.	.158	.0396	.684	83.2	90.3	.0325	.0445	12200	8950	2.78
Ti $K\alpha$	4511.	.160	.0394	.691	83.7	90.5	.0324	.0440	12200	8950	2.75
V $K\alpha$	4952.	.178	.0375	.748	87.2	92.0	.0310	.0397	11400	8920	2.50
Cr $K\alpha$	5415.	.197	.0354	.793	89.9	93.2	.0294	.0360	10900	8900	2.29
Mn $K\alpha$	5899.	.217	.0334	.827	91.8	94.2	.0277	.0328	10500	8890	2.10
Co $K\alpha$	6930.	.258	.0295	.877	94.5	95.8	.0245	.0276	10000	8900	1.79
Ni $K\alpha$	7478.	.279	.0278	.893	95.4	96.4	.0230	.0254	9860	8910	1.66
Cu $K\alpha$	8048.	.302	.0261	.911	96.1	96.8	.0216	.0235	9730	8920	1.54
Zn $K\alpha$	8639.	.325	.0246	.923	96.7	97.3	.0203	.0218	9630	8930	1.44
Pt $L\alpha$	9442.	.356	.0227	.936	97.3	97.7	.0187	.0199	9520	8940	1.31
Au $L\alpha$	9713.	.367	.0222	.939	97.5	97.8	.0182	.0193	9480	8940	1.28
Ge $K\alpha$	9886.	.375	.0218	.942	97.6	97.9	.0179	.0190	9470	8940	1.25
Hg $L\alpha$	9989.	.380	.0216	.943	97.7	98.0	.0177	.0188	9460	8950	1.24

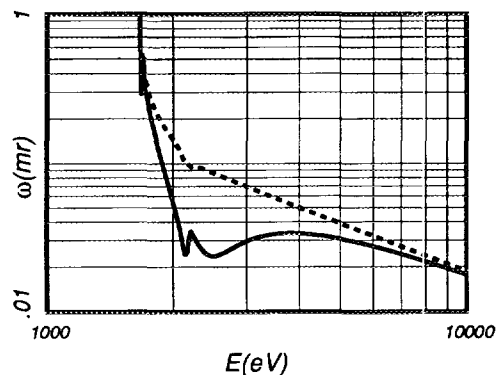
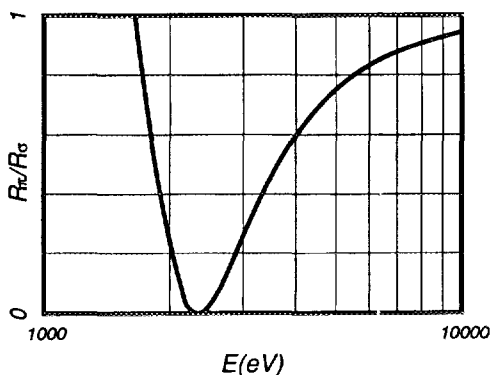
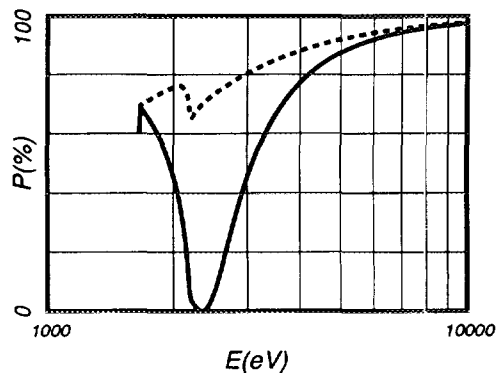
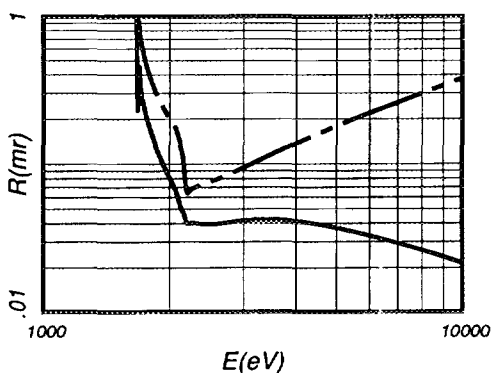

TABLE IV. Bragg Reflection Characteristics for Natural Crystals
See page 211 for Explanation of Tables

Pentaerythritol - PET (002)
 $C(CH_2OH)_4$
 $2d = 8.742\text{\AA}$

Line	E(eV)	R_m (mr)	R_p (mr)	R_π/R_σ	P_π (%)	P_σ (%)	ω_π (mr)	ω_σ (mr)	$E/\Delta E_\pi$	$E/\Delta E_\sigma$	λ (Å)	
Al	K α	1487.	1.31	.474	.778	78.4	85.3	.444	.534	7210	5990	8.34
Si	K α	1740.	.500	.151	.231	56.0	88.7	.0817	.238	17300	5910	7.13
Zr	L α	2042.	.409	.0881	.0054	5.08	91.5	.0131	.164	73800	5890	6.07
Nb	L α	2166.	.416	.0854	.0733	40.1	92.3	.0225	.147	38500	5880	5.72
Mo	L α	2293.	.432	.0850	.164	60.3	93.0	.0322	.134	24500	5880	5.41
Cl	K α	2622.	.500	.0831	.363	80.6	94.6	.0458	.109	14000	5890	4.73
Ag	L α	2984.	.591	.0789	.513	88.5	95.7	.0505	.0916	10700	5900	4.15
Ca	K α	3692.	.785	.0691	.687	94.4	97.2	.0497	.0702	8380	5930	3.36
Ba	L α	4466.	1.01	.0598	.790	96.8	98.1	.0450	.0563	7450	5950	2.78
Ti	K α	4511.	1.02	.0593	.795	96.9	98.1	.0447	.0556	7420	5960	2.75
V	K α	4952.	1.15	.0548	.830	97.6	98.4	.0419	.0501	7130	5970	2.50
Cr	K α	5415.	1.28	.0507	.859	98.1	98.7	.0392	.0454	6930	5980	2.29
Mn	K α	5899.	1.43	.0470	.882	98.5	98.9	.0366	.0414	6770	5990	2.10
Co	K α	6930.	1.74	.0405	.915	99.0	99.2	.0319	.0348	6550	6010	1.79
Ni	K α	7478.	1.91	.0377	.927	99.2	99.3	.0298	.0321	6480	6010	1.66
Cu	K α	8048.	2.09	.0352	.937	99.3	99.4	.0279	.0298	6420	6020	1.54
Zn	K α	8639.	2.28	.0329	.945	99.4	99.5	.0261	.0276	6370	6020	1.44
Pt	L α	9442.	2.54	.0302	.954	99.5	99.6	.0241	.0252	6310	6030	1.31
Au	L α	9713.	2.63	.0294	.957	99.6	99.6	.0234	.0245	6300	6030	1.28
Ge	K α	9886.	2.70	.0289	.958	99.6	99.6	.0230	.0240	6290	6030	1.25
Hg	L α	9989.	2.74	.0286	.959	99.6	99.6	.0228	.0238	6290	6030	1.24

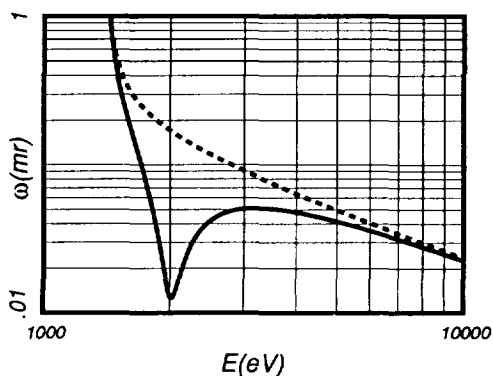
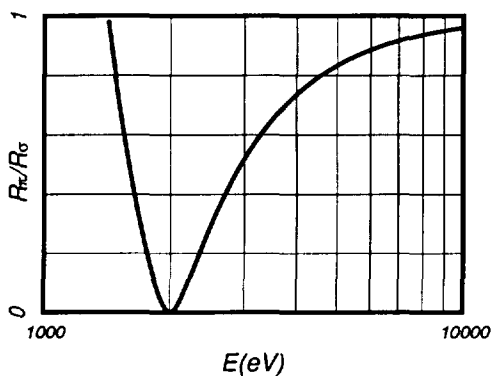
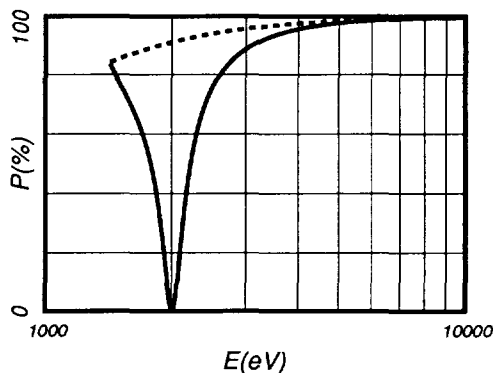
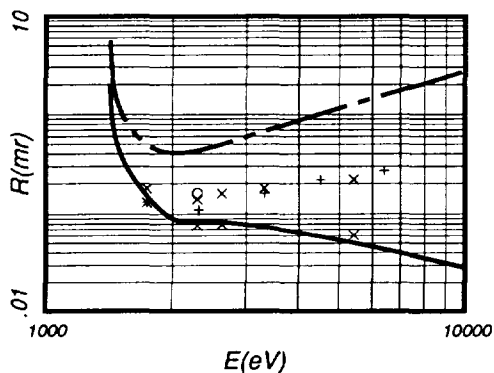

TABLE IV. Bragg Reflection Characteristics for Natural Crystals
See page 211 for Explanation of Tables

Ammonium Dihydrogen Phosphate -ADP (101)
 $\text{NH}_4\text{H}_2\text{PO}_4$
 $2d = 10.640\text{\AA}$

Line	E(eV)	$R_m(\text{mr})$	$R_p(\text{mr})$	R_π/R_σ	$P_\pi(\%)$	$P_\sigma(\%)$	$\omega_\pi(\text{mr})$	$\omega_\sigma(\text{mr})$	$E/\Delta E_\pi$	$E/\Delta E_\sigma$	$\lambda(\text{\AA})$
Ge $L\alpha$	1188.	.552	.402	.879	37.6	40.4	.769	.817	6780	6370	10.4
Mg $L\alpha$	1254.	.240	.174	.592	32.1	43.4	.305	.392	8310	6450	9.89
Al $K\alpha$	1487.	.107	.0672	.0770	9.48	52.8	.0714	.189	17700	6680	8.34
Si $K\alpha$	1740.	.0926	.0498	.0184	3.60	60.7	.0345	.131	26200	6890	7.13
Nb $L\alpha$	2166.	.0595	.0355	.250	28.4	59.2	.0378	.0776	17000	8230	5.72
Mo $L\alpha$	2293.	.0473	.0338	.288	22.6	51.0	.0488	.0804	12100	7340	5.41
Cl $K\alpha$	2622.	.0625	.0394	.453	39.7	60.1	.0476	.0727	10400	6830	4.73
Ag $L\alpha$	2984.	.0754	.0415	.588	53.2	67.0	.0460	.0641	9220	6620	4.15
Ca $K\alpha$	3692.	.0974	.0412	.744	69.4	76.2	.0418	.0518	7970	6430	3.36
Ti $K\alpha$	4511.	.121	.0381	.838	79.5	82.9	.0366	.0421	7310	6350	2.75
V $K\alpha$	4952.	.133	.0363	.869	83.0	85.4	.0341	.0382	7110	6330	2.50
Cr $K\alpha$	5415.	.145	.0343	.893	85.8	87.5	.0317	.0349	6960	6320	2.29
Mn $K\alpha$	5899.	.158	.0324	.911	88.0	89.3	.0294	.0319	6850	6320	2.10
Co $K\alpha$	6930.	.185	.0287	.938	91.3	92.0	.0254	.0270	6710	6330	1.79
Cu $K\alpha$	8048.	.214	.0254	.955	93.6	94.0	.0221	.0231	6620	6350	1.54
Zn $K\alpha$	8639.	.229	.0239	.961	94.4	94.7	.0206	.0214	6590	6360	1.44
Au $L\alpha$	9713.	.258	.0216	.970	95.6	95.8	.0184	.0190	6560	6370	1.28
Ge $K\alpha$	9886.	.263	.0213	.969	95.8	95.9	.0181	.0186	6550	6370	1.25
Hg $L\alpha$	9989.	.266	.0211	.969	95.9	96.0	.0179	.0184	6550	6370	1.24

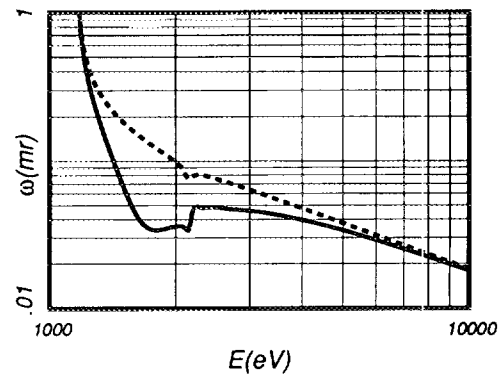
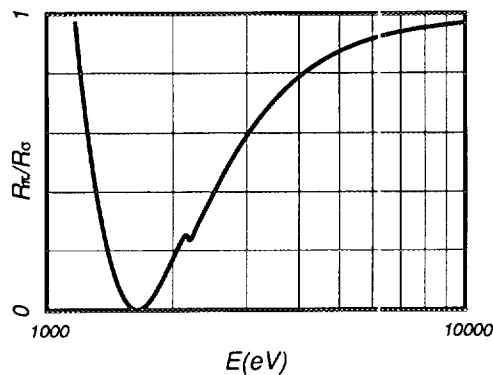
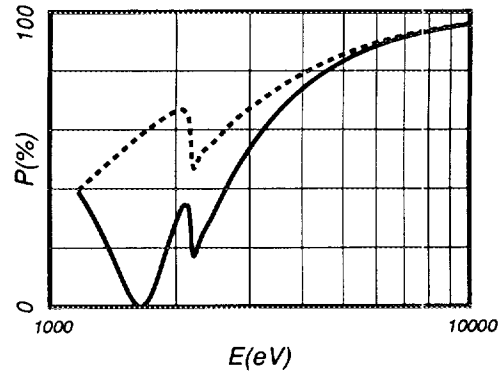
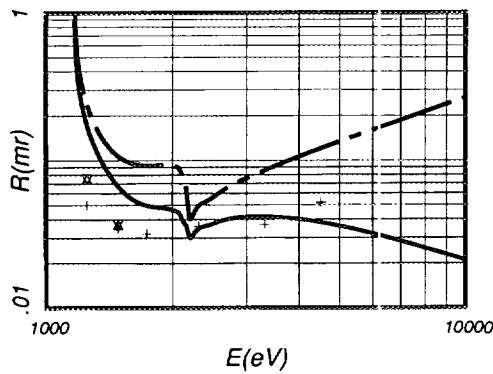

TABLE IV. Bragg Reflection Characteristics for Natural Crystals
See page 211 for Explanation of Tables

Mica (002)
 $K_2O \cdot 3Al_2O_3 \cdot 6SiO_2 \cdot 2H_2O$
 $2d = 19.840 \text{ \AA}$

Line	E(eV)	R_m (mr)	R_p (mr)	R_π/R_σ	P_π (%)	P_σ (%)	ω_π (mr)	ω_σ (mr)	$E/\Delta E_\pi$	$E/\Delta E_\sigma$	λ (Å)
Fe $L\alpha$	705.0	.0242	.0225	.303	.476	1.54	1.50	1.53	1240	1210	17.6
Co $L\alpha$	776.2	.0176	.0164	.0782	.175	2.17	.921	.958	1450	1390	16.0
Ni $L\alpha$	851.5	.0158	.0146	.0040	.0126	2.98	.632	.671	1680	1590	14.6
Cu $L\alpha$	929.7	.0155	.0143	.0121	.0498	3.86	.467	.504	1920	1780	13.3
Na $K\alpha$	1041.	.0160	.0147	.0855	.483	5.22	.326	.359	2280	2070	11.9
Mg $L\alpha$	1254.	.0177	.0161	.267	2.43	8.26	.192	.216	2980	2640	9.89
Al $K\alpha$	1487.	.0144	.0130	.435	4.51	9.53	.121	.134	3810	3440	8.34
Si $K\alpha$	1740.	.0204	.0185	.564	6.63	11.2	.140	.148	2730	2580	7.13
Nb $L\alpha$	2166.	.0179	.0161	.707	7.31	9.92	.127	.134	2350	2230	5.72
Mo $L\alpha$	2293.	.0191	.0171	.738	9.01	11.7	.113	.119	2490	2360	5.41
Ag $L\alpha$	2984.	.0262	.0218	.850	20.9	23.5	.0702	.0742	3030	2870	4.15
Ca $K\alpha$	3692.	.0296	.0236	.903	27.4	29.3	.0609	.0634	2800	2690	3.36
Ti $K\alpha$	4511.	.0225	.0172	.937	32.6	33.9	.0388	.0400	3580	3480	2.75
V $K\alpha$	4952.	.0230	.0168	.949	37.5	38.7	.0335	.0344	3770	3670	2.50
Cr $K\alpha$	5415.	.0239	.0165	.958	42.7	43.7	.0295	.0302	3910	3820	2.29
Co $K\alpha$	6930.	.0281	.0157	.977	57.3	57.9	.0219	.0222	4110	4040	1.79

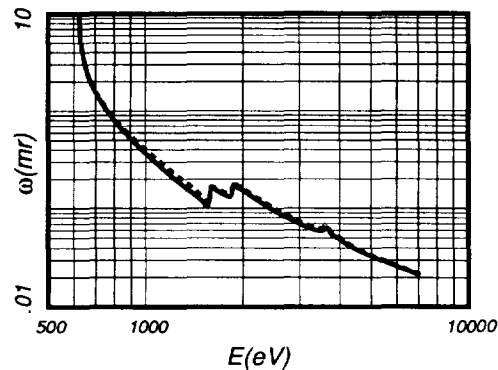
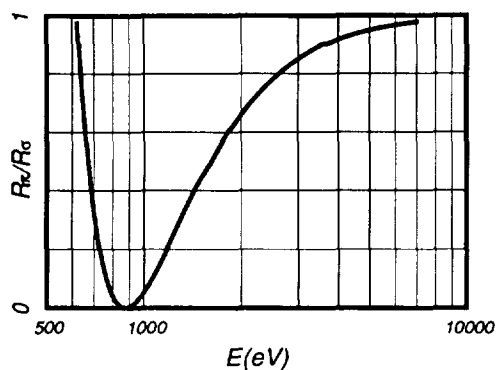
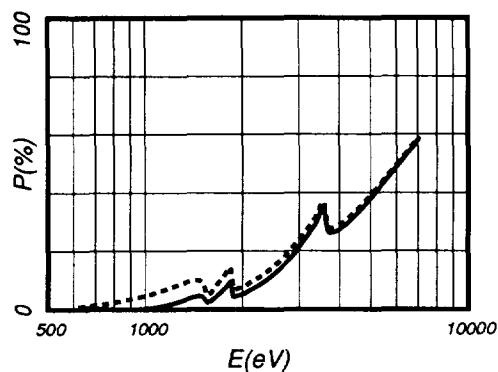
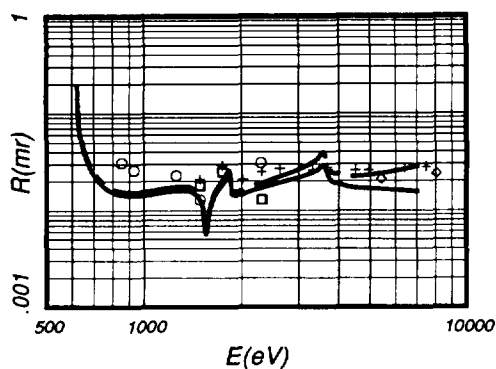

TABLE IV. Bragg Reflection Characteristics for Natural Crystals
See page 211 for Explanation of Tables

Thallium Acid Phthalate - TAP (001)
 $C_8H_4(COOH)(COO)TI$
 $2d = 25.763\text{\AA}$

Line	E(eV)	R_m (mr)	R_p (mr)	R_π/R_r	P_π (%)	P_σ (%)	ω_π (mr)	ω_σ (mr)	$E/\Delta E_\pi$	$E/\Delta E_\sigma$	λ (Å)
O $K\alpha$	524.9	.250	.238	.330	3.28	10.6	2.43	2.23	795.	866.	23.6
Cr $L\alpha$	572.8	.202	.193	.104	1.06	11.1	2.32	2.08	605.	674.	21.6
Fe $L\alpha$	705.0	.178	.168	.0155	.267	18.3	1.31	1.21	672.	731.	17.6
Co $L\alpha$	776.2	.189	.176	.0774	1.68	22.3	1.02	.989	734.	760.	16.0
Ni $L\alpha$	851.5	.207	.191	.162	4.27	26.5	.849	.842	771.	777.	14.6
Cu $L\alpha$	929.7	.228	.207	.253	8.06	30.9	.711	.736	816.	788.	13.3
Na $K\alpha$	1041.	.256	.226	.373	14.6	36.7	.584	.629	859.	796.	11.9
Mg $L\alpha$	1254.	.293	.243	.553	27.9	46.0	.446	.496	899.	808.	9.89
Al $K\alpha$	1487.	.317	.244	.683	40.2	53.9	.366	.405	904.	816.	8.34
Si $K\alpha$	1740.	.326	.232	.773	50.3	60.4	.307	.335	905.	830.	7.13
Nb $L\alpha$	2166.	.281	.184	.857	59.9	66.3	.222	.236	993.	934.	5.72
Mo $L\alpha$	2293.	.223	.149	.871	59.2	65.2	.183	.192	1140	1080	5.41
Ag $L\alpha$	2984.	.163	.139	.912	55.9	63.6	.163	.154	974.	1030	4.15
Ca $K\alpha$	3692.	.214	.158	.946	68.5	73.2	.166	.163	767.	780.	3.36
Ti $K\alpha$	4511.	.248	.155	.968	77.3	80.0	.157	.157	664.	664.	2.75
V $K\alpha$	4952.	.263	.150	.974	80.5	82.5	.150	.151	630.	628.	2.50

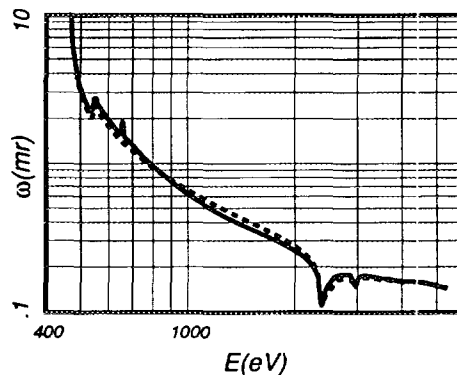
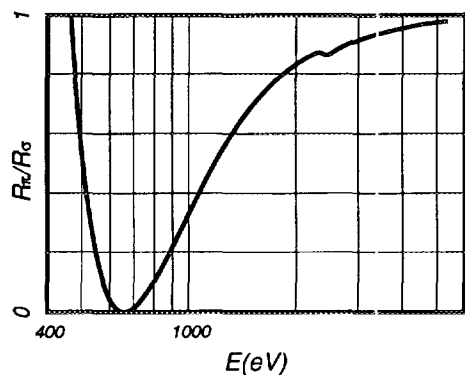
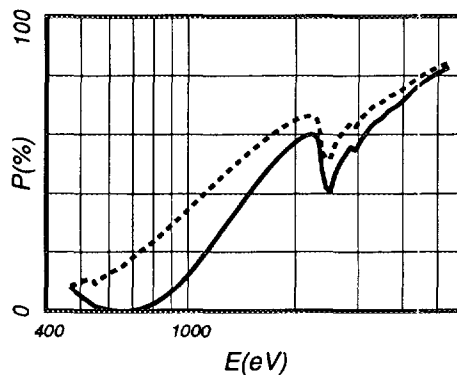
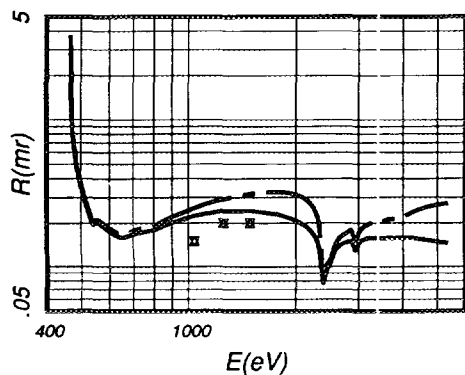
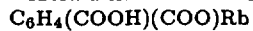

TABLE IV. Bragg Reflection Characteristics for Natural Crystals

See page 211 for Explanation of Tables

Rubidium Acid Phthalate - RAP (001)

$2d = 26.116\text{\AA}$

Line	E(eV)	R_m (mr)	R_p (mr)	R_π/R_σ	P_π (%)	P_σ (%)	ω_π (mr)	ω_σ (mr)	$E/\Delta E_\pi$	$E/\Delta E_\sigma$	λ (Å)	
O	K α	524.9	.110	.102	.408	2.27	5.50	1.77	1.80	1200	1180	23.6
Cr	L α	572.8	.0954	.0894	.141	.862	6.18	1.74	1.72	853.	864.	21.6
Fe	L α	705.0	.0844	.0772	.0086	.111	11.9	.810	.888	1130	1030	17.6
Co	L α	776.2	.0892	.0805	.0650	1.11	15.2	.605	.698	1280	1110	16.0
Ni	L α	851.5	.0965	.0858	.149	3.25	18.7	.470	.565	1430	1190	14.6
Cu	L α	929.7	.104	.0913	.242	6.42	22.4	.383	.472	1550	1260	13.3
Na	K α	1041.	.115	.0980	.365	12.1	27.5	.305	.381	1680	1340	11.9
Mg	L α	1254.	.130	.104	.548	23.8	36.5	.226	.278	1810	1480	9.89
Al	K α	1487.	.134	.0997	.681	34.7	44.0	.176	.208	1920	1620	8.34
Si	K α	1740.	.0912	.0672	.763	37.5	44.2	.118	.133	2410	2140	7.13
Nb	L α	2166.	.0961	.0826	.828	40.0	48.7	.131	.130	1710	1730	5.72
Mo	L α	2293.	.108	.0886	.850	45.3	53.1	.129	.129	1640	1640	5.41
Ag	L α	2984.	.145	.0962	.920	63.9	68.0	.113	.116	1430	1400	4.15
Ca	K α	3692.	.171	.0915	.953	74.7	76.9	.0984	.101	1320	1290	3.36
Ti	K α	4511.	.198	.0832	.971	82.1	83.3	.0848	.0864	1250	1230	2.75
V	K α	4952.	.212	.0788	.977	84.8	85.7	.0786	.0799	1230	1210	2.50
Cr	K α	5415.	.225	.0743	.981	87.1	87.7	.0728	.0738	1210	1190	2.29

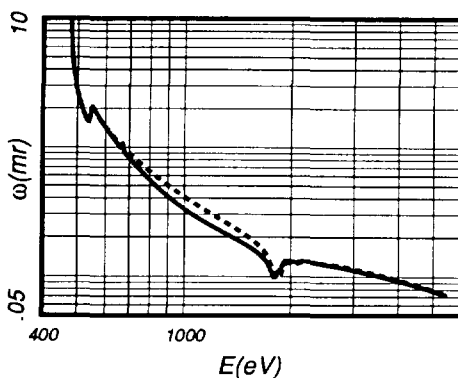
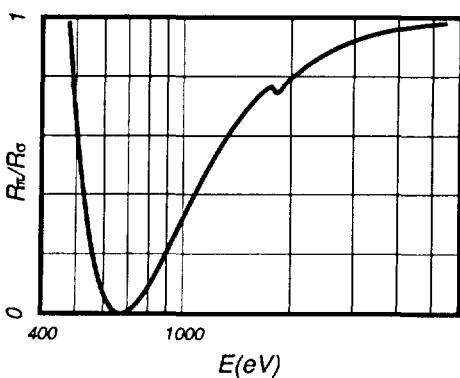
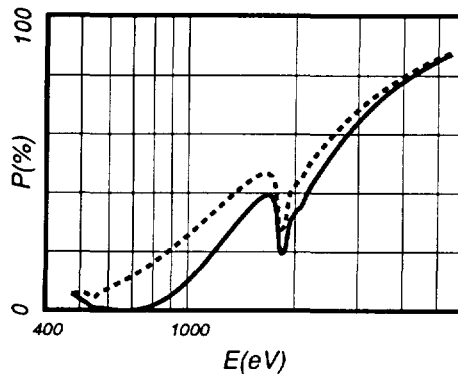
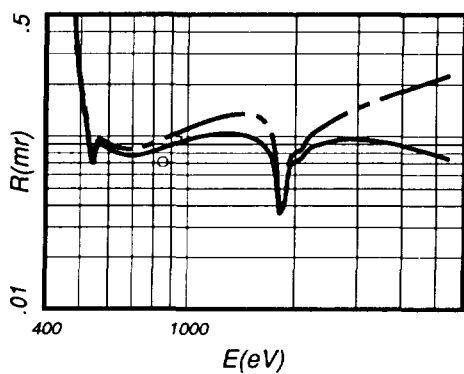
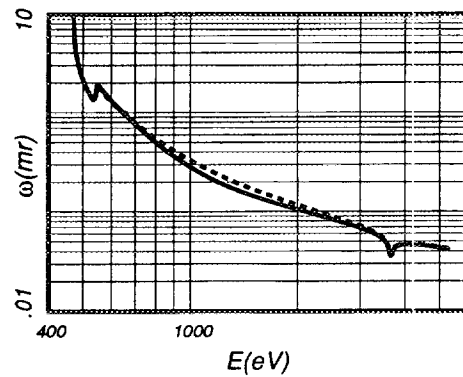
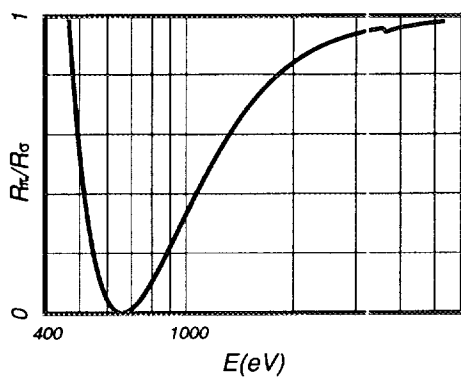
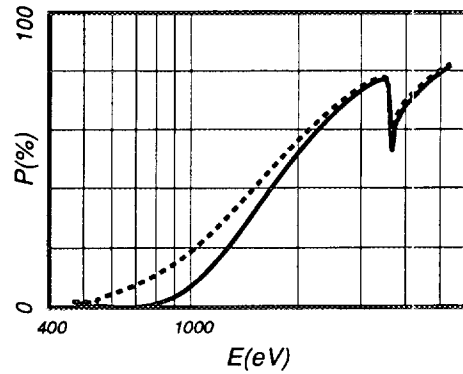
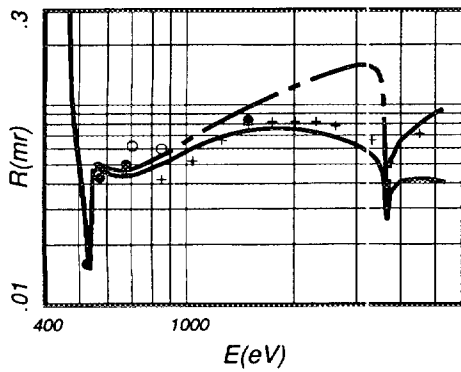

TABLE IV. Bragg Reflection Characteristics for Natural Crystals
See page 211 for Explanation of Tables

Potassium Acid Phthalate - KAP (001)
 $C_8H_4(COOH)(COO)K$
 $2d = 26.634 \text{ \AA}$

Line	E(eV)	R_m (mr)	R_p (mr)	R_π/E_σ	P_π (%)	P_σ (%)	ω_π (mr)	ω_σ (mr)	$E/\Delta E_\pi$	$E/\Delta E_\sigma$	λ (Å)
O $K\alpha$	524.9	.0239	.0224	.334	.516	1.55	1.48	1.47	1310	1320	23.6
Cr $L\alpha$	572.8	.0501	.0472	.105	.380	3.74	1.60	1.54	874.	908.	21.6
Fe $L\alpha$	705.0	.0475	.0441	.0139	.125	7.66	.751	.776	1180	1140	17.6
Co $L\alpha$	776.2	.0510	.0469	.0788	.844	10.1	.553	.596	1360	1260	16.0
Ni $L\alpha$	851.5	.0554	.0504	.165	2.31	12.8	.422	.472	1550	1390	14.6
Cu $L\alpha$	929.7	.0603	.0542	.256	4.49	15.7	.338	.387	1720	1500	13.3
Na $K\alpha$	1041.	.0687	.0604	.375	8.78	20.4	.262	.308	1920	1630	11.9
Mg $L\alpha$	1254.	.0829	.0688	.555	19.1	29.7	.186	.221	2160	1810	9.89
Al $K\alpha$	1487.	.0967	.0739	.687	30.9	39.3	.146	.171	2260	1930	8.34
Si $K\alpha$	1740.	.110	.0758	.779	42.3	48.4	.122	.138	2290	2010	7.13
Nb $L\alpha$	2166.	.130	.0739	.867	57.0	60.5	.0969	.106	2270	2080	5.72
Mo $L\alpha$	2293.	.135	.0725	.884	60.4	63.3	.0915	.0992	2270	2090	5.41
Ag $L\alpha$	2984.	.157	.0625	.937	73.1	74.5	.0686	.0720	2310	2200	4.15
Ca $K\alpha$	3692.	.0426	.0313	.947	58.2	61.0	.0395	.0399	3230	3200	3.36
Ti $K\alpha$	4511.	.0798	.0420	.970	74.9	76.3	.0455	.0463	2280	2250	2.75
V $K\alpha$	4952.	.0890	.0414	.976	79.0	80.0	.0435	.0441	2180	2140	2.50



REFERENCES FOR PHOTOABSORPTION DATA

1. C. G. Barkla and C. A. Sadler, *Philos. Mag.* **14**, 408–422 (1907).
2. C. G. Barkla and C. A. Sadler, *Philos. Mag.* **17**, 736–760 (1909).
3. R. Whiddington, *Proc. R. Soc. Lond.* **85**, 323–331 (1911).
4. S. J. M. Allen, *Phys. Rev.* **28**, 907–922 (1926).
5. E. Jonsson, Ph. D. Dissertation (University of Uppsala, Sweden, 1928).
6. H. Kurtz, *Ann. Phys.* **85**, 529–551 (1928).
7. I. Backhurst, *Philos. Mag.* **7**, 353–373 (1929).
8. W. W. Colvert, *Phys. Rev.* **36**, 1619–1624 (1930).
9. B. Woernle, *Ann. Phys. (Leipzig)* **5**, 475–506 (1930).
10. D. Coster and J. Veldkamp, *Z. Phys.* **70**, 306–316 (1931).
11. E. Dershem and M. Schein, *Phys. Rev.* **37**, 1238–1245 (1931).
12. H. Kustner, *Z. Phys.* **70**, 468–491 (1931).
13. R. G. Spencer, *Phys. Rev.* **39**, 178 (1932); see also: *Phys. Rev.* **38**, 1932–1937 (1931).
14. F. M. Uber, *Phys. Rev.* **38**, 217–224 (1931).
15. J. A. Crowther, and L. H. H. Orton, *Philos. Mag.* **13**, 505–523 (1932).
16. H. Kustner, *Z. Phys.* **77**, 52–59 (1932).
17. L. H. Martin, and K. C. Lang, *Proc. R. Soc. Lond. A* **137**, 199–216 (1932).
18. R. H. Messner, *Z. Phys.* **85**, 727–740 (1933).
19. S. J. M. Allen, *Phys. Rev.* **45**, 122–123 (1934).
20. L. H. Carr, *Phys. Rev.* **46**, 92–95 (1934).
21. K. Grosskurth, *Ann. Phys. (Leipzig)* **20**, 197–232 (1934).
22. T. N. White, *Phys. Rev.* **46**, 865–867 (1934).
23. G.B. Bandopadhyaya and A. T. Maitra, *Philos. Mag.* **21**, 869–880 (1936).
24. H. H. Biermann, *Ann. Phys.* **26**, 740–760 (1936).
25. K. Schulz, *Ann. Phys.* **27**, 1–14 (1936).
26. F. I. Callisen, *Z. Phys.* **107**, 15–43 (1937).
27. R. D. Hill, *Proc. R. Soc. Lond. A* **161**, 284–294 (1937).
28. C. L. Andrews, *Phys. Rev.* **54**, 994–999 (1938).
29. H. Hansen, *Ann. Phys.* **35**, 524–546 (1939).
30. W. Wrede, *Ann. Physik (Leipzig)* **36**, 681–695 (1939).
31. S. Laubert, *Ann. Phys. (Leipzig)* **40**, 553–578 (1941).
32. D. H. Tomboulian, E. M. Pell, *Phys. Rev.* **83**, 1196–1201 (1951).
33. J. Hubbell, (unpublished work, 1953, obtained from Ref. 233).
34. P. Lee and G. L. Weissler, *Proc. R. Soc. Lond. A* **219**, 71–76 (1953).
35. J. R. Townsend, *Phys. Rev.* **92**, 556–560 (1953).
36. R. W. Johnston and D. H. Tomboulian, *Phys. Rev.* **94**, 1585–1589 (1954).
37. D. R. Chipman, *J. Appl. Phys.* **26**, 1387 (1955).
38. P. Lee and G. L. Weissler, *Phys. Rev.* **99**, 540–542 (1955).
39. R. W. Woodruff and M. P. Givens, *Phys. Rev.* **97**, 52–54 (1955).
40. D. H. Tomboulian and D. E. Bedo, *Phys. Rev.* **104**, 590–597 (1956).
41. E. Baurmann and K. Ulmer, *Z. Naturforsch.* **12A**, 670–671 (1957).
42. P. Olmer and G. Champier, *C. R. Acad. Sci.* **245**, 542–543 (1957).
43. D. H. Tomboulian, D. E. Bedo, and W. M. Neupert, *J. Phys. Chem. Solids* **3**, 282–302 (1957).
44. B. W. Batterman, *Rev. Sci. Instrum.* **29**, 1132 (1958).
45. S. Ergun and V. Tiensuu, *J. Appl. Phys.* **29**, 946–949 (1958).
46. N. N. Axelrod and M. P. Givens, *Phys. Rev.* **115**, 97 (1959).
47. B. W. Batterman, *Phys. Rev.* **115**, 81–86 (1959).
48. R. D. Deslattes, Ph. D. Dissertation (John Hopkins Univ., Baltimore, MD 1959); AFOSR-TN-58-784 (1958).
49. J. I. Hopkins, *J. Appl. Phys.* **30**, 185–187 (1959).
50. R. B. Roof, Jr., *Phys. Rev.* **113**, 820–825 (1959).

REFERENCES FOR PHOTOABSORPTION DATA continued

51. R. W. Ditchburn, *Proc. Phys. Soc.* **75**, 461-462 (1960).
52. C. E. Ehrenfried and D. E. Dodds AFSWC-TN-59-33, **56** (1960).
53. A. S. Ganeev and I. M. Izrailev, *Sov. Phys. Tech. Phys.* **5**, 1016-1017 (1960).
54. P. Matin, Ph. D. Thesis (Vanderbilt Univ., Nashville, TN 1960).
55. A. Pery-Thorne and W. R. S. Garson, *Proc. Phys. Soc.* **76**, 833-843 (1960).
56. D. J. Baker, D. E. Bedo, and D. H. Tomboulian, *Phys. Rev.* **124**, 1471-1476 (1961).
57. U. Bonse, *Z. Phys.* **161**, 310-329 (1961).
58. B. Nordfors, *Ark. Fys.* **20**, 1-23 (1961).
59. W. R. Sweeny, R. T. Seal, and L. S. Birks, *Spectrochim. Acta* **17**, 364-365 (1961).
60. D. J. Baker, Jr., and D. H. Tomboulian, *Phys. Rev.* **128**, 677-680, (1962).
61. B. W. Batterman, *Phys. Rev.* **126**, 1461-1469 (1962).
62. W. G. Buckman, Ph. D. Thesis (Vanderbilt Univ., Nashville, TN 1962).
63. G. R. Dyer, Ph. D. Thesis (Emory Univ., Atlanta, GA 1962).
64. E. Noreland, *Ark. Fys.* **23**, 273-281 (1962).
65. H. W. Schnopper, Ph. D. Thesis (Cornell Univ., Ithaca, NY 1962).
66. B. Vodar, *J. Quant. Spectrosc. Radiat. Transfer.* **2**, 393-412 (1962).
67. H. Kroger and D. H. Tomboulian, *Phys. Rev.* **130**, 152-154 (1963).
68. A. P. Lukirskii and T. M. Zimkina, *Bull. Acad. Sci. USSR, Phys. Ser.* **27**, 817-820 (1963).
69. H. Sorum, *Phys. Norv.* **1**, 157-164 (1963).
70. R. W. Alexander, D. L. Ederer, and D. H. Tomboulian, *Bull. Am. Phys. Soc. (Ser. 2)* **9**, 626 (1964).
71. B. W. Batterman, *Phys. Rev.* **133**, 1759-1764 (1964).
72. M. Cole, J. B. Woodhouse, and G. D. Hughes, Technical Report, U. S. Dept. of Army, E. R. O. Contract DA-91-591-EUC 3094 (1964).
73. B. A. Cooke and E. A. Stewardson, *Br. J. Appl. Phys.* **15**, 1315-1319 (1964).
74. D. L. Ederer, *Phys. Rev. Lett.* **13**, 760-762 (1964).
75. D. L. Ederer, and D. H. Tomboulian, *Phys. Rev.* **133**, A1525-1532 (1964).
76. V. N. Karev, *Zavod. Lab.* **30**, 548-551 (1964).
77. M. Lefeld-Sosnowska, *Phys. Status Solidi* **7**, 449-462 (1964).
78. A. P. Lukirskii, I. A. Brytov, and T. M. Zimkina, *Opt. Spectrosc.* **17**, 234-237 (1964).
79. A. P. Lukirskii, E. P. Savinov, O. A. Ershov, and Y. F. Shepelev, *Opt. Spectrosc. (USSR)* **16**, 168-172 (1964).
80. W. T. Ogier, G. J. Lucas, and R. J. Park, *Appl. Phys. Lett.* **5**, 146-147 (1964).
81. O. P. Rustgi, *J. Opt. Soc. Am.* **54**, 464-466 (1964).
82. O. P. Rustgi, E. I. Fisher, and C. H. Fuller, *J. Opt. Soc. Am.* **54**, 745-746 (1964).
83. J. A. Samson, *J. Opt. Soc. Am.* **54**, 420-421 (1964).
84. J. A. Samson, *J. Opt. Soc. Am.* **54**, 876-877 (1964).
85. J. A. Samson, *J. Opt. Soc. Am.* **54**, 1491 (1964).
86. M. J. Cooper, *Acta Crystallogr.* **18**, 813 (1965).
87. P. Duncumb and D. A. Melford, *Proc. 4th Int. Congr. X-Ray Optics and Microanalysis, Paris* (1965).
88. J. F. Lowry, D. H. Tomboulian, and D. L. Ederer, *Phys. Rev.* **137**, A1054-1057 (1965).
89. F. M. Matsunga, R. S. Jackson, and K. Watanabe, *J. Quant. Spectrosc. Radiat. Transfer* **5**, 329-333 (1965).
90. A. Merlini and S. Pace, *Nuovo Cimento, (Ser. 10)* **35**, 377-390 (1965).
91. C. T. Prevo and J. L. Cate, UCR-14680, *Hazards Control Quarterly Rep.*, No. **23**, 1-7 (1965).
92. J. A. Samson, *J. Opt. Soc. Am.* **55**, 935-937 (1965).
93. T. Watanabe, *Phys. Rev.*, **137**, A1380-1382 (1965).
94. C. Weissmantel and M. Wunschmann, *Z. Chem.* **5**, 191-193 (1965).
95. A. J. Bearden, *J. Appl. Phys.* **37**, 1681-1692 (1966).
96. K. Codling, R. P. Madden, W. R. Hunter, and D. W. Angel, *J. Opt. Soc. Am.* **56**, 189-192 (1966).
97. R. Gableske and M. Moring, *Z. Angew. Phys.* **21**, 246-249 (1966).

REFERENCES FOR PHOTOABSORPTION DATA continued

98. K. F. J. Heinrich, *The Electron Microprobe* (Wiley, New York 1966) p. 296-377.
99. W. R. Hunter, *Optical Properties and Electronic Structures of Metal and Alloys*, ed. F. Abels (North Holland, Amsterdam, 1966) p. 136.
100. P. Jaegle and G. Missoni, *C. R. Acad. Sci., Ser. B* **262**, 71-74 (1966).
101. A. P. Lukirskii, I. A. Brytov, and S. A. Griborskii, *Opt. Spectrosc.* **20**, 203-204 (1966).
102. A. P. Lukirskii, T. M. Zimkina, and S. A. Gribovskii, *Sov. Phys. Solid State* **8**, 1525-1526 (1966).
103. T. O. Baldwin, F. W. Young, Jr., and A. Merlini, *Phys. Rev.* **163**, 591-598 (1967).
104. G. V. Bezdenezhnykh, A. L. Zapysov, I. M. Israilev, and V. N. Saprykin, *Opt. Spectrosc.* **23**, 533 (1967).
105. R. W. Carter, R. H. Rohrer, W. R. Carlton, and G. R. Dyer, *Health Physics* **13**, 593-599 (1967).
106. N. K. DelGrande, R. J. Stinner, and A. J. Oliver, (Unpublished work, 1967, obtained from Ref. 233).
107. O. A. Ershov, *Opt. Spectrosc.* **22**, 252-255 (1967).
108. O. A. Ershov, I. A. Brytov, and A. P. Lukirskii, *Opt. Spectrosc.* **22**, 127-134 (1967).
109. V. A. Fomichev and A. P. Lukirskii, *Opt. Spectrosc.* **22**, 432-434 (1967).
110. R. Haensel, C. Kunz, and B. Sonntag, *Phys. Lett.*, **25A**, 205-206 (1967).
111. B. L. Henke, R. L. Elgin, R. E. Lent, and R. B. Ledingham, *Norelco Reporter* **14**, 112-131 (1967).
112. R. D. Hudson, and V. L. Carter, *J. Opt. Soc. Am.* **57**, 651-654 (1967).
113. J. L. Perkin, and A. C. Douglas, *Proc. Phys. Soc., Lond.* **92**, 618-621 (1967).
114. S. Singer, *J. Appl. Phys.* **38**, 2897-2898 (1967).
115. I. I. Zhukova, V. A. Fomichev, and T. M. Zimkina, *Bull. Acad. Si. USSR, Phys. Ser.* **31**, 967-971 (1967).
116. T. M. Zimkina, V. A. Fomichev, S. A. Gribovskii, and I. I. Zhukova, *Sov. Phys. - Solid State* **9**, 1128-1130 (1967).
117. F. H. Combley, E. A. Stewardson, and J. E. Wilson, *J. Phys. B* **1**, 120-127 (1968).
118. R. D. Deslattes, *Phys. Rev. Lett.* **20**, 483-485 (1968).
119. B. Ekstig, *Ark. Fys.* **37**, 107-116 (1968).
120. V. A. Fomichev and I. I. Zhukova, *Opt. Spectrosc. (USSR)* **24**, 147-148 (1968).
121. V. A. Fomichev and I. I. Zhukova, *Opt. Spectrosc.* **24**, 284-286 (1968).
122. R. Haensel, C. Kunz, T. Sasaki, and B. Sonntag, *Appl. Optics* **7**, 301-306 (1968).
123. P. K. Hon and K. F. J. Heinrich, (unpublished work, 1968, obtained from Ref. 233).
124. R. D. Hudson and V. L. Carter, *J. Opt. Soc. Am.* **58**, 430-431 (1968).
125. P. Jaegle, F. Combet-Farnoux, P. Dhez, M. Cremonese, and G. Onori, *Phys. Lett.* **26A**, 364-365 (1968).
126. M. Jarvinen, M. Merisalo, and O. Inkinen, *Phys. Rev.* **178**, 1108-1110 (1968).
127. E. Kohlhaas and F. Scheiding, *Proc. 5th Int. Congr. X-Ray Optics and Microanalysis*, Tübingen, W. Germany (1968).
128. W. Weisweiler, *Proc. 5th Int. Congr. X-Ray Optics and Microanalysis*, Tübingen, W. Germany (1968).
129. N. G. Alexandropoulos, *Rev. Sci. Instrum.* **40**, 952-954 (1969).
130. J. L. Dalton and J. Goldak, *Can. Spectrosc.* **14**, 171-173 (1969).
131. N. K. Del Grande, J. H. Mallet, and A. J. Oliver, (Unpublished data and also data listed in Lawrence Livermore National Laboratory, Livermore, CA, UCRL-50174, 1969).
132. N. K. Del Grande, R. J. Stinner and A. J. Oliver, (Unpublished data and also data from Lawrence Livermore National Laboratory, Livermore, CA, UCRL-50174, 1969).
133. O. Efimov and E. Persson, *Sov. Phys. Solid State* **10**, 1756-1758 (1969).
134. G. Grimvall and E. Persson, *Acta. Crystallogr., Sect. A* **25** Part 3, 417-422 (1969).
135. R. Haensel, B. Sonntag, C. Kunz, and T. Sasaki, *J. Appl. Phys.* **40**, 3046-3047 (1969).
136. R. Haensel, K. Radler, B. Sonntag, and C. Kunz, *Solid State Commun.* **7**, 1495-1497 (1969).
137. R. Haensel, G. Keitel, P. Schreiber, and C. Kunz, *Phys. Rev.* **188**, 1375-1380 (1969).
138. G. Senemaud, *J. Phys. (Paris)* **30**, 811-818 (1969).

REFERENCES FOR PHOTOABSORPTION DATA continued

139. B. Sonntag, R. Haensel, and C. Kunz, *Solid State Commun.* **7**, 597 (1969) See also: B. Sonntag, Ph. D. Thesis (Univ. of Hamburg, Hamburg, W. Germany 1969).
140. F. Wuilleumier, Ph. D. Thesis (Lab. Chim. Phys., Paris 1969).
141. F. C. Brown, C. Gahwiller, H. Fujita, A. B. Kunz, W. Scheifley, and N. Carrera, *Phys. Rev. B* **2**, 2126-2138 (1970).
142. M. Cardona, W. Gudat, B. Sonntag, and P. Y. Yu, DESY F41-70/6 (1970).
143. D. R. Denne, *J. Phys. D* **3**, 1392-1398 (1970).
144. D. R. Denne, *J. Phys. D* **3**, 1405-1406 (1970).
145. P. Dhez and P. Jaegle, CNRS Colloq. No. 196 (1970).
146. C. Gahwiller and F. C. Brown, *Phys. Rev. B* **2**, 1918-1925 (1970).
147. R. Haensel, G. Keitel, B. Sonntag, C. Kunz, and P. Schreiber, *Phys. Stat. Sol. A* **2**, 85-90 (1970).
148. R. Haensel, P. Rabe, and B. Sonntag, *Solid State Commun.* **8**, 1845-1848 (1970).
149. P. Lublin, P. Cuko, and R. J. Jaworowski, *Advances in X-ray Analysis* (Plenum Press, New York, 1970) **13**, p. 632-638.
150. J. H. McCrary, L. D. Looney, and E. F. Atwater, *J. Appl. Phys.* **41**, 3570-3572 (1970).
151. J. H. McCrary, L. D. Looney, C. P. Constanten, and H. F. Atwater, *Phys. Rev. A* **2**, 2439-2497 (1970).
152. B. Ortner, H. Ebel, and F. Lihl, *Mikrochim. Acta, Suppl. IV*, 270-279 (1970).
153. S. W. Bennett, J. B. Tellinghuisen, and L. F. Phillips, *J. Physical Chem.*, **75**, 719-721 (1971).
154. N. K. Del Grande and A. J. Oliver, *Bull. Am. Phys. Soc. (Ser. 2)* **16**, 545 (1971).
155. L. De Reilac and N. Damany-Astoin, *J. Phys. C* **4**, 32-36 (1971).
156. C. Ghezzi, A. Merlini, and S. Pace, *Phys. Rev. B* **4**, 1833-1842 (1971).
157. D. Ottewell, J. E. Wilson, and A. J. Larrad, *J. Phys. E* **4**, 740-742 (1971).
158. F. C. Brown and O. P. Rustgi, *Phys. Rev. Lett.* **28**, 497-500 (1972).
159. D. F. Kyser, *Proc. 6th Int. Conf. on X-Ray Optics and Microanalysis* (Univ. of Tokyo Press, Tokyo, Japan 1972) p. 147-156.
160. J. E. McClintock, A. Levine, and S. Rappaport, *Rev. Sci. Instr.* **43**, 902-905 (1972).
161. W. L. Starr and M. Loewenstein, *J. Geophys. Res.* **77**, 4790-4796 (1972).
162. W. S. Watson, *J. Phys. B* **5**, 2292-2303 (1972).
163. H. W. Wolff, K. Radler, B. Sonntag, and R. Haensel, *Z. Physik* **257**, 353-368 (1972).
164. R. W. Carlson, D. L. Judge, M. Ogawa, and L. C. Lee, *App. Opt.* **12**, 409-412 (1973).
165. F. J. Comes, U. Nielson, and W. H. E. Schwarz, *J. Chem. Phys.* **58**, 2230-2237 (1973).
166. N. K. Del Grande and A. J. Oliver, *Bull. Am. Phys. Soc.* **18**, 635 (1973).
167. M. D. Giardina, and A. Merlini, *Z. Naturforsch.* **28A**, 360-365 (1973).
168. S. A. Gribovskii and T. M. Zimkin, *Sov. Phys. Sol. Stat.* **15**, 217-218 (1973).
169. B. L. Henke and E. S. Ebsu, *Advances in X-ray Analysis* (Plenum Press, New York, 1973) **17**, p. 150-213.
170. G. Hildebrandt, J. D. Stephenson, and H. Wagenfeld, *Z. Naturforsch.* **28A**, 588-600 (1973).
171. M. Hribar, A. Kodre, A. Moljk, and J. Pahor, *Fizika* **5**, 171-177 (1973).
172. R. H. Millar, (unpublished work, 1973, obtained from Ref. 233).
173. B. Sonntag, T. Tuomi, and G. Zimmerer, *Phys. Stat. Sol. (b)* **58**, 101-110 (1973).
174. M. Cukier, P. Dhez, F. Wuilleumier, and P. Jaegle, *Phys. Lett. A* **48**, 307-308 (1974).
175. M. Mantler, *X-Ray Spectrometry* **3**, 90-98 (1974).
176. R. H. Millar and J. R. Greening, *J. Phys. B* **7**, 2332-2344 (1974).
177. K. Parthasaradhi and H. H. Hanseri, *Phys. Rev. A* **10**, 563-568 (1974).
178. T. S. Rao-Sahib and D. B. Wittry, *J. Appl. Phys.* **45**, 5060-5068 (1974).
179. P. Rabe, K. Radler, H. W. Wolff, *Proc. of 4th Inter. Conf. on VUV Rad. Phys.*, Hamburg, W. Germany, 1974, p. 247-249.
180. L. Singman, *J. Appl. Phys.* **45**, 1885-1887 (1974).
181. C. Wehenkel and B. Gauthé, *Phys. Lett.* **47A**, 253-254 (1974).
182. L. D. Calvert, R. C. G. Killean, and A. Mathieson, *Acta Crystallogr. A* **31**, 855-856 (1975).

REFERENCES FOR PHOTOABSORPTION DATA continued

183. M. Cukier, P. Dhez, P. Jaegle, and F. C. Farnoux, *Phys. Lett.* **51A**, 173-174 (1975).
184. N. Damany-Astoin, (unpublished work, 1975, obtained from Ref. 233).
185. H. J. Hagemann, W. Gudat and C. Kunz, *J. Opt. Soc. Am.* **65**, 742-745 (1975).
186. J. Lang and W. S. Watson, *J. Phys. B* **8**, L339-343 (1975).
187. T. C. Loomis and H. D. Keith, *Appl. Spectrosc.* **29**, 316-322 (1975).
188. A. Lurio and W. Reuter, *Appl. Phys. Lett.* **27**, 704-706 (1975).
189. M. A. Short and J. Tabock, *X-Ray Spectrom.* **4**, 119-122 (1975).
190. J. Bordas and J. B. West, *Phil. Mag.* **34**, 501-505 (1976).
191. W. Hartl and J. W. Hammer, *Z. Phys. A* **279**, 135-139 (1976).
192. C. Senemaud and M. T. Costa Lima, *J. Phys. Chem. Solids* **37**, 83-87 (1976).
193. W. J. Steele and J. M. Johnson, Lawrence Livermore National Laboratory, Livermore, CA, UCRL-77839 (1976).
194. J. B. West and G. V. Marr, *Proc. R. Soc. Lond. A* **349**, 397-421 (1976).
195. K. Codling, J. R. Hamley, and J. B. West, *J. Phys. B* **10**, 2797-2807 (1977).
196. D. C. Creagh, *Phys. Status Solidi A* **39**, 705-715 (1977).
197. G. Jézéquel, J. C. Lemonnier, and J. Thomas, *J. Phys. F* **7**, 1613-1622 (1977).
198. G. Jézéquel, J. C. Lemonnier, and J. Thomas, *J. Phys. F* **7**, 2613-2621 (1977).
199. J. K. Lawrence, *Acta Crystallogr., Sect. A* **33**, 343 (1977).
200. A. Lurio, W. Reuter, and J. Keller, *Advances in X-ray Analysis* (Plenum Press, New York 1977) **20**, p. 481-486.
201. V. R. K. Murty, et al., *Nuovo Cimento A* **39**, 125-130 (1977).
202. D. V. Rao, G. F. Govelitz, and K. S. R. Sastry, *Med. Phys.* **4**, 109-114 (1977).
203. K. S. Rao, V. R. K. Murty, K. Parthasaradhi, J. R. Rao, and V. Lakshimarayana, *Pramana* **9**, 321-328 (1977).
204. J. A. R. Samson, J. L. Gardner, and G. N. Haddad, *J. Electron Spectrosc. and Related Phenom.* **12**, 281-292 (1977).
205. Shahnawaz, and V. V. Rao, *Curr. Sci.* **46**, 256 (1977).
206. W. J. Steele, Lawrence Livermore National Laboratory, Livermore, CA, UCRL-75503 (1977).
207. K. Codling, J. R. Hamley, and J. B. West, *J. Phys. B* **11**, 1713-1716 (1978).
208. A. Ejiri, F. Sugawara, and H. Onuki, *Jap. J. Appl. Phys.* **17** Supplement 17-2, 204-207 (1978).
209. G. V. Marr, *J. Phys. B* **11**, L121-123 (1978).
210. G. Mehlman, D. L. Ederer, and E. B. Salomon, *J. Chem. Phys.* **68**, 1862-1864 (1978).
211. V. V. Truong, L. J. LeBlanc, and G. J. Turpin, *J. Opt. Soc. Am.* **68**, 1017-1018 (1978).
212. M. D. Barrus, R. L. Blake, A. J. Burek, K. C. Chambers, and A. L. Pregenzer, *Phys. Rev. A* **20**, 1045-1061 (1979).
213. A. A. Berry and J. L. Lawrence, *Acta Cryst.* **35**, 316-318 (1979).
214. R. Bruhn, B. Sonntag, and H. W. Wolff, *J. Phys. B* **12**, 203-212 (1979).
215. J. L. Lawrence, *Acta Crystallogr. A* **35**, 845-848 (1979).
216. K. S. Puttaswamy, R. Gowda, and B. Sanjeevaiah, *Can. J. Chem.* **57**, 92-98 (1979).
217. A. Hemidy and B. de Thy, *Analysis* **8**, 138-41 (1980).
218. J. A. Samson, private communication, (1980).
219. W. E. Wall, M. W. Ribarsky, and J. R. Stevenson, *J. Appl. Phys.* **51**, 661-667 (1980).
220. N. K. Del Grande, and A. J. Oliver, Lawrence Livermore National Laboratory, Livermore, CA, UCRL-85683 (1981).
221. A. Quemarais, B. Loisel, G. Jézéquel, J. Thomas, and J. C. Lemonnier, *J. Phys. F* **11**, 293-303 (1981).
222. V. V. Rao, Shahnawaz, and D. V. Rao, *Physica C* **111**, 107-110 (1981).
223. J. H. Weaver, C. Krafska, D. W. Lynch, E. E. Koch, *Optical Properties of Metals* (Fachinformationszentrum Energie—Physik—Mathematik, Karlsruhe, W. Germany 1981).
224. G. F. Schafer and K. F. Fischer, *Z. Krystallogr.* **159**, 303-309 (1982).
225. L. Gerward, *Acta Cryst. A* **39**, 322-325 (1983).

REFERENCES FOR PHOTOABSORPTION DATA *continued*

226. E. O. Filatova, A. S. Vinogradov, I. A. Sorokin, and T. M. Zimkina, *Sov. Phys. Solid State* **25**, 736–739 (1983).
227. F. E. Girouard, and V-V. Truong, *J. Opt. Soc. Am. B* **1**, 76–79 (1984).
228. J. A. R. Samson and P. N. Parek, *Phys. Rev. A* **31**, 1470–1476 (1985).
229. N. K. Del Grande, *Proc. SPIE* **691**, 2–10 (1986).
230. N. K. Del Grande and K. G. Tirsell, (private communication, 1987).
231. N. K. Del Grande, and T. W. Barbee, (private communication, 1987).
232. D. L. Windt, W. Cash, M. Scott, P. Arendt, B. Newnam, R. F. Fisher, A. B. Swartzlander, P. Z. Takacs, and M. Pinneo, *App. Opt.*, **27**, 279 (1988); D. L. Windt, W. Cash, M. Scott, P. Arendt, B. Newnam, R. F. Fisher, and A. B. Swartzlander, *App. Opt.*, **27**, 246 (1988).
233. D. L. Windt and J. B. Kortright, *Proc. SPIE* **1160**, 246 (1989).
234. E. B. Saloman, J. H. Hubbell, and J. H. Scofield, *Atomic Data and Nuclear Data Tables* **38**, 1–197 (1988).
235. M. Richter, M. Meyer, M. Pahler, T. Prescher, E. v. Raven, B. Sontag, and H. E. Wetzell, *Phys. Rev. A*, **39**, 5666 (1989).
236. M. Richter, M. Meyer, M. Pahler, T. Prescher, E. v. Raven, B. Sontag, and H. E. Wetzell, *Phys. Rev. A*, **40**, 7007 (1989).